



FRÜHJAHR/SOMMER 2019

K A T A L O G



Binde
Optik

WWW.BINDE-OPTIK.DE

Katalog ab 1. Januar 2019

Es gelten die Verkaufs-, Lieferungs- und Zahlungsbedingungen der Walter Binde GmbH & Co. KG

Walter Binde Optik GmbH & Co. KG

Königstraße 134b | D-32427 Minden
Postfach 2160 | D-32378 Minden

Auftragsannahme: +49 (0)5 71 / 2 80 13

+49 (0)5 71 / 2 80 14

Telefax: +49 (0)5 71 / 8 51 11

Nach Geschäftsschluss Anrufbeantworter

Bestellung: bestellung@binde-optik.de

Buchhaltung: fibu@binde-optik.de

www.binde-optik.de

Fassungen Titelseite

8238-16

8278-04

5498-16

| | |
|--|-----------|
| › LOOK & FEEL Damen Metall-, Cell- und Clip-On-Fassungen | 2 – 22 |
| › LOOK & FEEL Herren Metall-, Cell-, Beflex- und Clip-on-Fassungen | 23 – 42 |
| › women Damen Metallfassungen | 43 – 46 |
| › men Herren Metallfassungen | 47 – 48 |
| › Jump Up und Jump Up Teens | 49 – 54 |
| › Kids One | 55 – 60 |
| › Skylight Titan | 61 – 65 |
| › Readers | 66 – 70 |
| › Start Up – Premium, Classic, Fashion, Readers, Basics | 71 – 100 |
| › Marketing-Service | 102 – 103 |
| › Zertifikat zur Biokompatibilität | 104 |
| › Allergieschutzbeschichtung, Rechtlicher Hinweis, Pflegehinweis | 105 |
| › AGB | 106 – 107 |
| › Inhalt nach Modellnummern | 108 |

| Farb-Nr. | Farbe / Color |
|----------|---|
| 01 | silber / silver |
| 02 | gold / gold |
| 03 | bi-color / gold & silver |
| 04 | weiss / white |
| 05 | rosa / rose, salmon-coloured, pink |
| 06 | gelb / yellow |
| 07 | hellblau / light blue |
| 08 | blau / blue |
| 09 | orange, hellrot / orange, light red |
| 10 | rot, bordeaux / red, bordeaux |
| 11 | hellbraun, havanna / light brown, havanna |
| 12 | braun / brown |
| 13 | hellgrau / light grey |
| 14 | silberantik, gun, grau / silverantik, gun, grey, anthracite |
| 15 | grün / green |
| 16 | schwarz / black |
| 17 | lila, flieder / lilac |



URBAN STYLE

LOOK & FEEL



5488-15

LOOK & FEEL
EYEWEAR COLLECTION



8279-02



8274-16

Neuere Brillen im mega angesagten Style – für junge Frauen und Damen. Anspruchsvolle Retro-Fassungen für Designbewusste: z. B. Kombis mit coolem Materialmix, leichte Pantoformen oder Doppelsteg in Roségold. Wertige und aufwendige Modelle für Damen. Und der Preis? Cool & überschaubar! Einfach happy mit Brillen von LOOK & FEEL.



8277-08

» Look & Feel Damen Metall-, Cell- und Clip-On-Fassungen

LOOK & FEEL **8279**

NEU

LOOK & FEEL
EYEWEAR COLLECTION



STAINLESS STEEL
premium selection

Farbe 16 Edelstahl, Kunststoffbügel

Größen 48-19

Farben 02
08
14
16
48
19
140
43
14

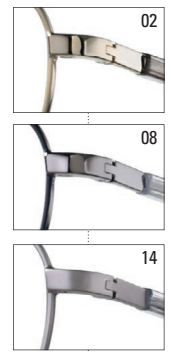

LOOK & FEEL **8278**

NEU

LOOK & FEEL
EYEWEAR COLLECTION



STAINLESS STEEL
premium selection

Farbe 02 Edelstahl, Kunststoffbügel

Größen 51-17

Farben 02
04
08
16
51
17
135
45
14

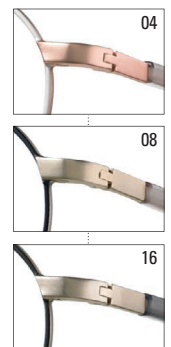

LOOK & FEEL **8277**

NEU

LOOK & FEEL
EYEWEAR COLLECTION



STAINLESS STEEL
premium selection

Farbe 04 Edelstahl, Kunststoffbügel

Größen 53-17

Farben 02
04
08
16
53
17
135
43
14

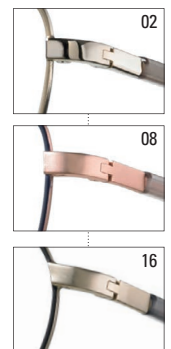

LOOK & FEEL **8276**

NEU

LOOK & FEEL
EYEWEAR COLLECTION



STAINLESS STEEL
premium selection

Farbe 08 Edelstahl, Kunststoffbügel

Größen 48-18

Farben 05
08
16
48
18
135
39
15

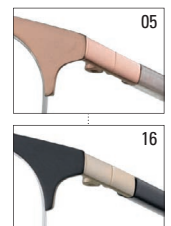

» Look & Feel Damen Metall-, Cell- und Clip-On-Fassungen

LOOK & FEEL **8275**

NEU

LOOK & FEEL
EYEWEAR COLLECTION



STAINLESS STEEL
premium selection

Farbe 05 Edelstahl, Federscharnier

- Größen 51-17
Farben 02
04
05
16
51
17
135
40
17

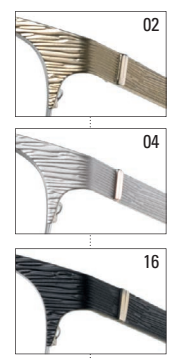

LOOK & FEEL **8274**

NEU

LOOK & FEEL
EYEWEAR COLLECTION



STAINLESS STEEL
premium selection

Farbe 02 Edelstahl, Federscharnier

- Größen 49-18
Farben 02
05
08
16
49
18
135
41
13

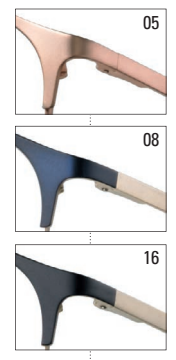

LOOK & FEEL **8273**

NEU

LOOK & FEEL
EYEWEAR COLLECTION



STAINLESS STEEL
premium selection

Farbe 02 Edelstahl, Federscharnier

- Größen 53-16
Farben 02
04
05
12
53
16
135
39
15

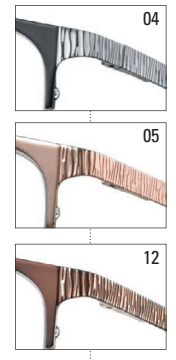

LOOK & FEEL **8272**

NEU

LOOK & FEEL
EYEWEAR COLLECTION



STAINLESS STEEL
premium selection

Farbe 12 Edelstahl, Kunststoffbügel

- Größen 52-15
Farben 04
12
16
52
15
135
37
14

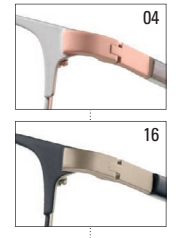

› Look & Feel Damen Metall-, Cell- und Clip-On-Fassungen

LOOK & FEEL **8271**

NEU

LOOK & FEEL
EYEWEAR COLLECTION



- Größen 52-17
Farben 02
04
08
16
52
17
135
36
17

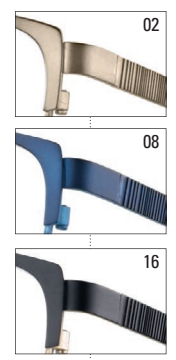

Farbe 04 Edelstahl, Federscharnier

STAINLESS STEEL
premium selection

LOOK & FEEL **8270**

NEU

LOOK & FEEL
EYEWEAR COLLECTION



- Größen 54-16
Farben 02
10
16
54
16
135
36
15

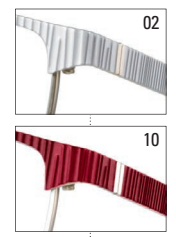

Farbe 16 Edelstahl, Federscharnier

STAINLESS STEEL
premium selection

LOOK & FEEL **8263**

LOOK & FEEL
EYEWEAR COLLECTION



- Größen 49-18
Farben 01
02
12
16
49
18
135
42
12

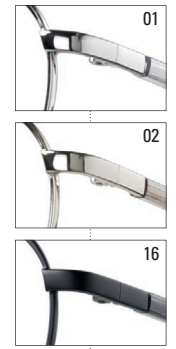

Farbe 12 Edelstahl, Kunststoffbügel

STAINLESS STEEL
premium selection

LOOK & FEEL **8262**

LOOK & FEEL
EYEWEAR COLLECTION



- Größen 53-18
Farben 02
05
16
53
18
135
45
13

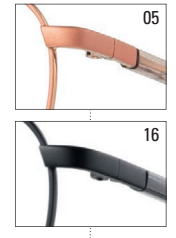

Farbe 02 Edelstahl, Kunststoffbügel

STAINLESS STEEL
premium selection

» Look & Feel Damen Metall-, Cell- und Clip-On-Fassungen

LOOK & FEEL **8261**



LOOK & FEEL
EYEWEAR COLLECTION

- Größen 51-17
Farben 04
05
12
51
17
135
40
14

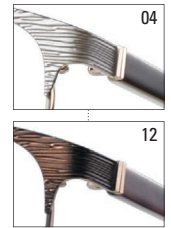

Farbe 05 Edelstahl, Kunststoffbügel

STAINLESS STEEL
premium selection

LOOK & FEEL **8260**



LOOK & FEEL
EYEWEAR COLLECTION

- Größen 52-17
Farben 10
12
16
52
17
135
35
13

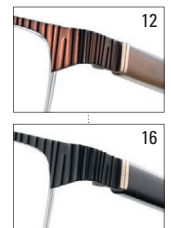

Farbe 10 Edelstahl, Kunststoffbügel

STAINLESS STEEL
premium selection

LOOK & FEEL **8259**



LOOK & FEEL
EYEWEAR COLLECTION

- Größen 53-16
Farben 10
12
14
16
53
16
135
39
12

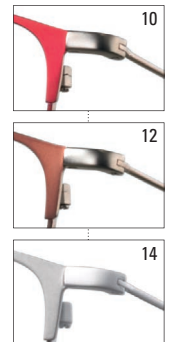

Farbe 16 Edelstahl

STAINLESS STEEL
premium selection

LOOK & FEEL **8258**



LOOK & FEEL
EYEWEAR COLLECTION

- Größen 52-17
Farben 04
05
06
16
52
17
135
36
14

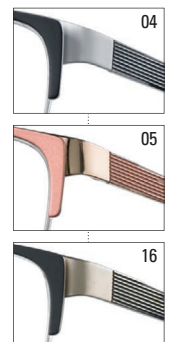

Farbe 06 Edelstahl, Federscharnier

STAINLESS STEEL
premium selection

» Look & Feel Damen Metall-, Cell- und Clip-On-Fassungen

LOOK & FEEL **8257**

LOOK & FEEL
EYEWEAR COLLECTION



STAINLESS STEEL
premium selection

Farbe 04 Edelstahl, Federscharnier, Kunststoffbügel

Größen 56-16

Farben 04

08

10

16



56



16



135



38



16



08



10



16

LOOK & FEEL **8255**

LOOK & FEEL
EYEWEAR COLLECTION



STAINLESS STEEL
premium selection

Farbe 16 Edelstahl, Federscharnier

Größen 54-16

Farben 04

08

16



54



16



135



37



15



04



08

LOOK & FEEL **8254**

LOOK & FEEL
EYEWEAR COLLECTION



STAINLESS STEEL
premium selection

Farbe 05 Edelstahl, Federscharnier, Kunststoffbügel

Größen 54-17

Farben 04

05

15

16



54



17



135



37



17



04

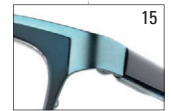

15



16

LOOK & FEEL **8253**

LOOK & FEEL
EYEWEAR COLLECTION



STAINLESS STEEL
premium selection

Farbe 04 Edelstahl, Federscharnier

Größen 53-18

Farben 04

05

16



53



18



135



37



16



05



16

» Look & Feel Damen Metall-, Cell- und Clip-On-Fassungen

LOOK & FEEL **8252**



LOOK & FEEL
EYEWEAR COLLECTION

Größen 52-18

- Farben 02
14
16
52
18
135
44
13

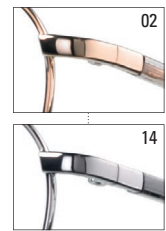

STAINLESS STEEL
premium selection

Farbe 16 Edelstahl, Kunststoffbügel

LOOK & FEEL **8238**



LOOK & FEEL
EYEWEAR COLLECTION

Größen 49-20

- Farben 12
15
16
49
20
135
40
16

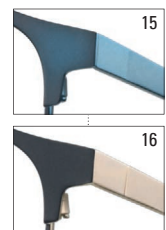

STAINLESS STEEL
premium selection
MAGNETIC CLIP-ON
polarized lenses



Gewicht ohne Clip
inkl. Etui

Farbe 12 Edelstahl, Federscharnier, Magnet-Clip-On

LOOK & FEEL **8237**



LOOK & FEEL
EYEWEAR COLLECTION

Größen 48-21

- Farben 04
08
12
16
48
21
135
40
17

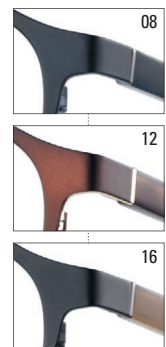

STAINLESS STEEL
premium selection
MAGNETIC CLIP-ON
polarized lenses



Gewicht ohne Clip
inkl. Etui

Farbe 04 Edelstahl, Federscharnier, Kunststoffbügel,
Magnet-Clip-On

LOOK & FEEL **8236**



LOOK & FEEL
EYEWEAR COLLECTION

Größen 53-16

- Farben 08
12
15
16
53
16
135
40
17

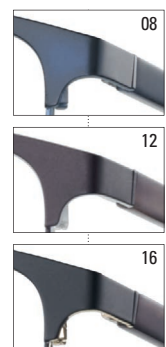

STAINLESS STEEL
premium selection
MAGNETIC CLIP-ON
polarized lenses



Gewicht ohne Clip
inkl. Etui

Farbe 15 Edelstahl, Federscharnier, Kunststoffbügel,
Magnet-Clip-On

» Look & Feel Damen Metall-, Cell- und Clip-On-Fassungen

LOOK & FEEL **8235**

LOOK & FEEL
EYEWEAR COLLECTION



- Größen 52-17
Farben 08
10
12
52
17
135
39
14

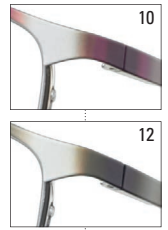

Farbe 08 Edelstahl, Federscharnier

STAINLESS STEEL
premium selection

LOOK & FEEL **8234**

LOOK & FEEL
EYEWEAR COLLECTION



- Größen 53-16
Farben 08
10
16
53
16
135
38
16

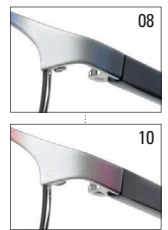

Farbe 16 Edelstahl, Kunststoffbügel

STAINLESS STEEL
premium selection

LOOK & FEEL **8232**

LOOK & FEEL
EYEWEAR COLLECTION



- Größen 54-17
Farben 08
10
12
54
17
135
36
17

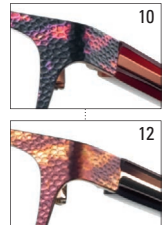

Farbe 08 Edelstahl, Federscharnier, Kunststoffbügel

STAINLESS STEEL
premium selection

LOOK & FEEL **8231**

LOOK & FEEL
EYEWEAR COLLECTION



- Größen 52-16
Farben 10
12
16
52
16
135
34
17

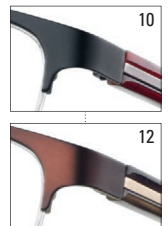

Farbe 16 Edelstahl, Federscharnier, Kunststoffbügel

STAINLESS STEEL
premium selection

» Look & Feel Damen Metall-, Cell- und Clip-On-Fassungen

LOOK & FEEL **8229**

LOOK & FEEL
EYEWEAR COLLECTION



- Größen 52-17
Farben 04
10
12
52
17
135
35
16

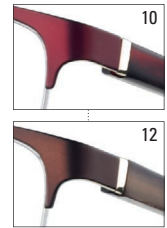

Farbe 04 Edelstahl, Federscharnier, Kunststoffbügel

STAINLESS STEEL
premium selection

LOOK & FEEL **8228**

LOOK & FEEL
EYEWEAR COLLECTION



- Größen 53-16
Farben 08
12
16
53
16
135
36
16

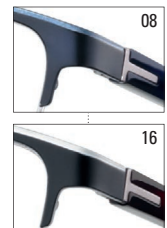

Farbe 12 Edelstahl, Federscharnier, Kunststoffbügel

STAINLESS STEEL
premium selection

LOOK & FEEL **8227**

LOOK & FEEL
EYEWEAR COLLECTION



- Größen 53-16
Farben 08
12
16
17
53
16
135
36
17

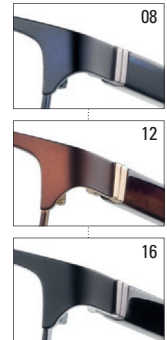

Farbe 17 Edelstahl, Federscharnier, Kunststoffbügel

STAINLESS STEEL
premium selection

LOOK & FEEL **8226**

LOOK & FEEL
EYEWEAR COLLECTION



- Größen 53-16
Farben 08
12
15
17
53
16
135
39
14

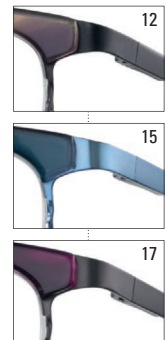

Farbe 08 Edelstahl, Federscharnier, Kombifassung

STAINLESS STEEL
premium selection

» Look & Feel Damen Metall-, Cell- und Clip-On-Fassungen

LOOK & FEEL **8225**



LOOK & FEEL
EYEWEAR COLLECTION

Größen 52-17

Farben 08

12

15

16

52

17

135

39

12

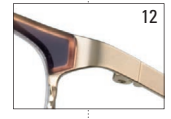
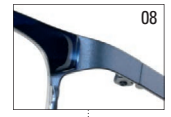

Farbe 15 Edelstahl, Kombifassung

STAINLESS STEEL
premium selection

LOOK & FEEL **8213**



LOOK & FEEL
EYEWEAR COLLECTION

Größen 48-18

Farben 08

12

15

16

48

18

135

40

13

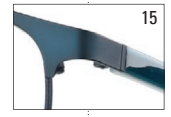
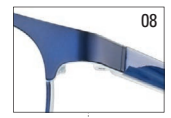

Farbe 12 Edelstahl, Kunststoffbügel

STAINLESS STEEL
premium selection

LOOK & FEEL **8212**



LOOK & FEEL
EYEWEAR COLLECTION

Größen 56-17

Farben 08

10

16

56

17

135

40

16

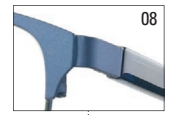

Farbe 10 Edelstahl, Federscharnier, Kunststoffbügel

STAINLESS STEEL
premium selection

LOOK & FEEL **8203**



LOOK & FEEL
EYEWEAR COLLECTION

Größen 54-17

Farben 10

12

16

54

17

135

34

16



Farbe 10 Edelstahl, Federscharnier, Kunststoffbügel

STAINLESS STEEL
premium selection

» Look & Feel Damen Metall-, Cell- und Clip-On-Fassungen

LOOK & FEEL **8202**

LOOK & FEEL
EYEWEAR COLLECTION



- Größen 55-17
Farben 10
12
16
55
17
135
37
18



Farbe 12 Edelstahl, Federscharnier, Kunststoffbügel

STAINLESS STEEL
premium selection

LOOK & FEEL **8197**

LOOK & FEEL
EYEWEAR COLLECTION



- Größen 53-16
Farben 08
10
12
53
16
135
36
16



Farbe 12 Edelstahl, Federscharnier, Kunststoffbügel

STAINLESS STEEL
premium selection

LOOK & FEEL **8194**

LOOK & FEEL
EYEWEAR COLLECTION



- Größen 54-16
Farben 08
10
12
54
16
135
38
12

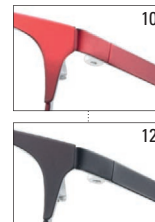

Farbe 08 Edelstahl

STAINLESS STEEL
premium selection

LOOK & FEEL **8192**

LOOK & FEEL
EYEWEAR COLLECTION



- Größen 49-16
Farben 10
12
16
49
16
130
33
14



Farbe 10 Edelstahl, Federscharnier, Kunststoffbügel

STAINLESS STEEL
premium selection

› Look & Feel Damen Metall-, Cell- und Clip-On-Fassungen

LOOK & FEEL **8191**

LOOK & FEEL
EYEWEAR COLLECTION

- Größen 53-16
Farben 12
16
53
16
135
36
11



STAINLESS STEEL
premium selection

Farbe 12 Edelstahl

LOOK & FEEL **8178**

LOOK & FEEL
EYEWEAR COLLECTION

- Größen 53-17
Farben 10
15
53
17
135
37
12



STAINLESS STEEL
premium selection

Farbe 10 Edelstahl, Federscharnier

LOOK & FEEL **8177**

LOOK & FEEL
EYEWEAR COLLECTION

- Größen 52-17
Farben 08
10
12
52
17
135
37
11

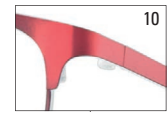

STAINLESS STEEL
premium selection

Farbe 08 Edelstahl

LOOK & FEEL **8160**

LOOK & FEEL
EYEWEAR COLLECTION

- Größen 56-16
Farben 10
12
16
56
16
140
36
20



STAINLESS STEEL
premium selection

Farbe 12 Edelstahl, Federscharnier, Kunststoffbügel

» Look & Feel Damen Metall-, Cell- und Clip-On-Fassungen

LOOK & FEEL **8158**

LOOK & FEEL
EYEWEAR COLLECTION

- Größen 52-17
Farben 12
14
52
17
135
37
18



STAINLESS STEEL
premium selection

Farbe 12 Edelstahl, Federscharnier, Kunststoffbügel

LOOK & FEEL **8153**

LOOK & FEEL
EYEWEAR COLLECTION

- Größen 53-17
Farben 08
16
53
17
135
37
15



STAINLESS STEEL
premium selection

Farbe 16 Edelstahl, Federscharnier

LOOK & FEEL **8147**

LOOK & FEEL
EYEWEAR COLLECTION

- Größen 53-15
Farben 12
16
53
15
135
34
15



STAINLESS STEEL
premium selection

Farbe 16 Edelstahl, Federscharnier

LOOK & FEEL **8139**

LOOK & FEEL
EYEWEAR COLLECTION

- Größen 52-17
Farben 12
14
52
17
135
34
16



STAINLESS STEEL
premium selection

Farbe 14 Edelstahl, Federscharnier, Kunststoffbügel

» Look & Feel Damen Metall-, Cell- und Clip-On-Fassungen

LOOK & FEEL **5498**

NEU

LOOK & FEEL
EYEWEAR COLLECTION



XTRA LIGHT ACETATE
premium selection

- Größen 53-17
Farben 05
08
11
16
53
17
135
44
12

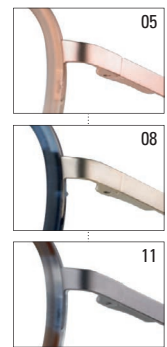

Farbe 16 Zelluloseacetat, Edelstahl, Federscharnier, Kombifassung

LOOK & FEEL **5497**

NEU

LOOK & FEEL
EYEWEAR COLLECTION



XTRA LIGHT ACETATE
premium selection

- Größen 49-15
Farben 05
12
14
16
49
15
135
38
12

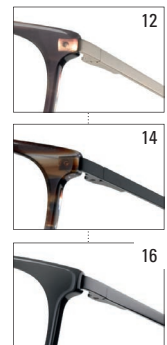

Farbe 05 Zelluloseacetat, Federscharnier, Metallbügel

LOOK & FEEL **5496**

NEU

LOOK & FEEL
EYEWEAR COLLECTION



XTRA LIGHT ACETATE
premium selection

- Größen 50-18
Farben 12
15
16
50
18
140
42
13

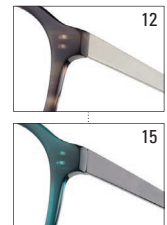

Farbe 16 Zelluloseacetat, Federscharnier, Stegstütze

LOOK & FEEL **5495**

NEU

LOOK & FEEL
EYEWEAR COLLECTION



XTRA LIGHT ACETATE
premium selection

- Größen 47-16
Farben 08
12
14
16
47
16
135
37
12

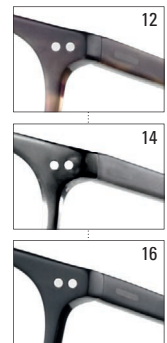

Farbe 08 Zelluloseacetat, Federscharnier

» Look & Feel Damen Metall-, Cell- und Clip-On-Fassungen

LOOK & FEEL **5492**

NEU

LOOK & FEEL
EYEWEAR COLLECTION



XTRA LIGHT ACETATE
premium selection

- Größen 53-16
Farben 05
10
12
15
53
16
135
38
13

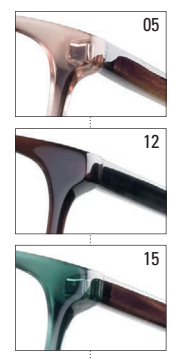

Farbe 10 Zelluloseacetat, Federscharnier

LOOK & FEEL **5491**

NEU

LOOK & FEEL
EYEWEAR COLLECTION



XTRA LIGHT ACETATE
premium selection

- Größen 53-15
Farben 11
12
15
16
53
15
135
39
10

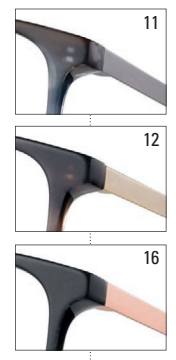

Farbe 15 Zelluloseacetat, Metallbügel

LOOK & FEEL **5490**

NEU

LOOK & FEEL
EYEWEAR COLLECTION



XTRA LIGHT ACETATE
premium selection

- Größen 51-17
Farben 05
11
12
16
51
17
135
42
11

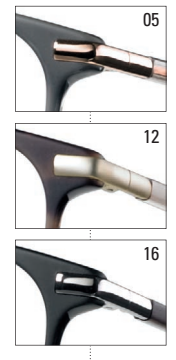

Farbe 11 Zelluloseacetat

LOOK & FEEL **5489**

NEU

LOOK & FEEL
EYEWEAR COLLECTION



XTRA LIGHT ACETATE
premium selection

- Größen 48-17
Farben 11
12
14
16
48
17
135
40
10

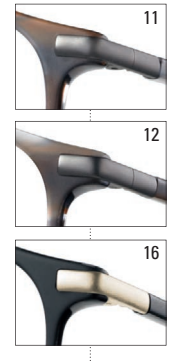

Farbe 14 Zelluloseacetat

» Look & Feel Damen Metall-, Cell- und Clip-On-Fassungen

LOOK & FEEL **5488**

NEU

LOOK & FEEL
EYEWEAR COLLECTION



XTRA LIGHT ACETATE
premium selection

- Größen 49-19
Farben 05
12
15
16
49
19
135
42
12

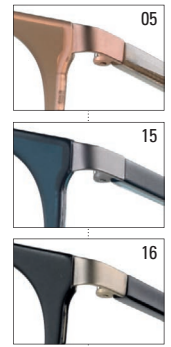

Farbe 12 Zelluloseacetat, Edelstahl, Kombifassung

LOOK & FEEL **5487**

NEU

LOOK & FEEL
EYEWEAR COLLECTION



XTRA LIGHT ACETATE
premium selection

- Größen 49-19
Farben 05
12
15
16
49
19
135
43
13

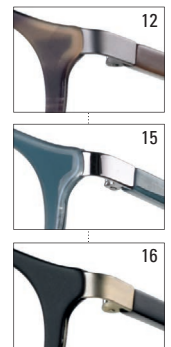

Farbe 05 Zelluloseacetat, Edelstahl, Kombifassung

LOOK & FEEL **5484**

LOOK & FEEL
EYEWEAR COLLECTION



XTRA LIGHT ACETATE
premium selection

- Größen 53-17
Farben 12
14
15
16
53
17
135
41
14

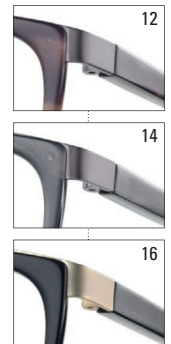

Farbe 15 Zelluloseacetat, Edelstahl, Federscharnier, Kombifassung

LOOK & FEEL **5483**

LOOK & FEEL
EYEWEAR COLLECTION



XTRA LIGHT ACETATE
premium selection

- Größen 50-18
Farben 08
11
12
16
50
18
135
42
14

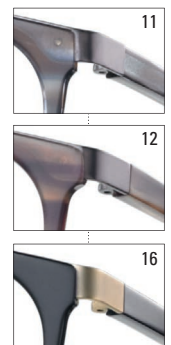

Farbe 08 Zelluloseacetat, Edelstahl, Federscharnier, Kombifassung

» Look & Feel Damen Metall-, Cell- und Clip-On-Fassungen

LOOK & FEEL **5482**

LOOK & FEEL
EYEWEAR COLLECTION



XTRA LIGHT ACETATE
premium selection

Größen 51-16

- Farben 10
12
15
51
16
135
39
13



Farbe 12 Zelluloseacetat

LOOK & FEEL **5475**

LOOK & FEEL
EYEWEAR COLLECTION



XTRA LIGHT ACETATE
premium selection

Größen 49-20

- Farben 08
14
16
49
20
140
39
13



Farbe 16 Zelluloseacetat, Edelstahl, Federscharnier, Kombifassung

LOOK & FEEL **5474**

LOOK & FEEL
EYEWEAR COLLECTION



XTRA LIGHT ACETATE
premium selection

Größen 46-20

- Farben 05
11
15
16
46
20
135
37
12



Farbe 05 Zelluloseacetat, Edelstahl, Federscharnier, Kombifassung

LOOK & FEEL **5470**

LOOK & FEEL
EYEWEAR COLLECTION



XTRA LIGHT ACETATE
premium selection

Größen 54-16

- Farben 12
15
16
17
54
16
135
38
14



Farbe 17 Zelluloseacetat, Federscharnier

» Look & Feel Damen Metall-, Cell- und Clip-On-Fassungen

LOOK & FEEL **5469**

LOOK & FEEL
EYEWEAR COLLECTION



XTRA LIGHT ACETATE
premium selection

Größen 51-17
Farben 08

- 11
- 12
- 16
- 51
- 17
- 140
- 41
- 12

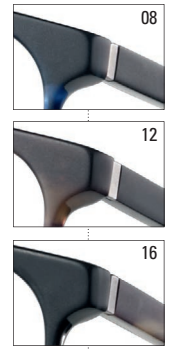

Farbe 11 Zelluloseacetat

LOOK & FEEL **5468**

LOOK & FEEL
EYEWEAR COLLECTION



XTRA LIGHT ACETATE
premium selection

Größen 52-14
Farben 08

- 10
- 15
- 52
- 14
- 135
- 38
- 11

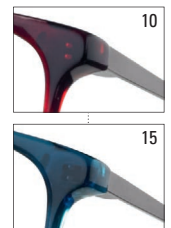

Farbe 08 Zelluloseacetat, Metallbügel

LOOK & FEEL **5467**

LOOK & FEEL
EYEWEAR COLLECTION



XTRA LIGHT ACETATE
premium selection

Größen 52-12
Farben 11

- 12
- 14
- 52
- 12
- 135
- 37
- 11

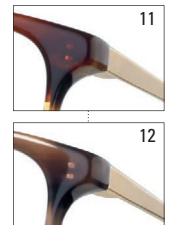

Farbe 14 Zelluloseacetat, Metallbügel

LOOK & FEEL **5466**

LOOK & FEEL
EYEWEAR COLLECTION



XTRA LIGHT ACETATE
premium selection

Größen 48-19
Farben 05

- 08
- 12
- 15
- 48
- 19
- 140
- 37
- 12

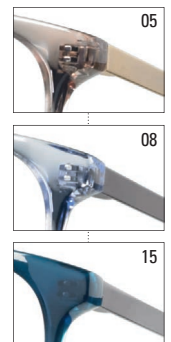

Farbe 12 Zelluloseacetat, Metallbügel, Stegstütze

» Look & Feel Damen Metall-, Cell- und Clip-On-Fassungen

LOOK & FEEL **5465**

LOOK & FEEL
EYEWEAR COLLECTION



XTRA LIGHT ACETATE
premium selection

Größen 53-16

- Farben 11
12
15
16
53
16
140
38
10

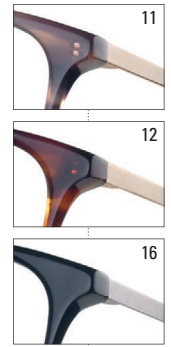

Farbe 15 Zelluloseacetat, Metallbügel

LOOK & FEEL **5464**

LOOK & FEEL
EYEWEAR COLLECTION



XTRA LIGHT ACETATE
premium selection

Größen 52-18

- Farben 08
12
16
52
18
140
43
11

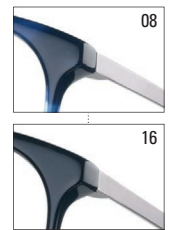

Farbe 12 Zelluloseacetat, Metallbügel

LOOK & FEEL **5463**

LOOK & FEEL
EYEWEAR COLLECTION



XTRA LIGHT ACETATE
premium selection

Größen 53-19

- Farben 11
12
16
53
19
140
42
11

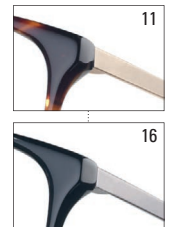

Farbe 12 Zelluloseacetat, Metallbügel

LOOK & FEEL **5461**

LOOK & FEEL
EYEWEAR COLLECTION



XTRA LIGHT ACETATE
premium selection

Größen 48-18

- Farben 08
15
16
48
18
140
38
10

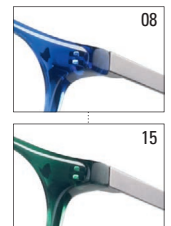

Farbe 16 Zelluloseacetat, Metallbügel

» Look & Feel Damen Metall-, Cell- und Clip-On-Fassungen

LOOK & FEEL **5441**



LOOK & FEEL
EYEWEAR COLLECTION

- Größen 54-16
Farben 10
12
16
54
16
135
39
11

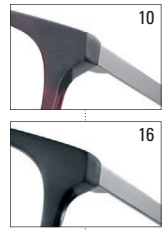

Farbe 12 Zelluloseacetat, Metallbügel

XTRA LIGHT ACETATE
premium selection

LOOK & FEEL **5440**



LOOK & FEEL
EYEWEAR COLLECTION

- Größen 53-12
Farben 10
12
16
53
12
135
35
14

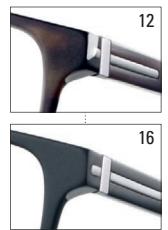

Farbe 10 Zelluloseacetat

XTRA LIGHT ACETATE
premium selection

LOOK & FEEL **5439**



LOOK & FEEL
EYEWEAR COLLECTION

- Größen 55-15
Farben 11
12
16
55
15
135
39
14

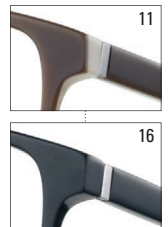

Farbe 12 Zelluloseacetat, Federscharnier

XTRA LIGHT ACETATE
premium selection

LOOK & FEEL **5437**



LOOK & FEEL
EYEWEAR COLLECTION

- Größen 48-18
Farben 10
12
16
48
18
135
38
10

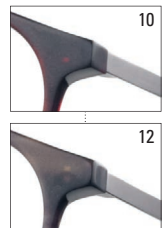

Farbe 16 Zelluloseacetat, Metallbügel

XTRA LIGHT ACETATE
premium selection

» Look & Feel Damen Metall-, Cell- und Clip-On-Fassungen

LOOK & FEEL **5435**



LOOK & FEEL
EYEWEAR COLLECTION

Größen 54-16

Farben 10

12

17

54

16

135

39

15

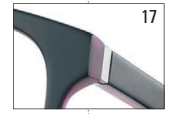

Farbe 12 Zelluloseacetat, Stegstütze

XTRA LIGHT ACETATE
premium selection

LOOK & FEEL **5434**



LOOK & FEEL
EYEWEAR COLLECTION

Größen 53-16

Farben 10

12

15

16

53

16

135

34

16

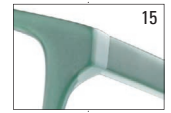

Farbe 12 Zelluloseacetat, Stegstütze

XTRA LIGHT ACETATE
premium selection



Starke, lässige Fassungen für stylebewusste Herren: z.B. leichte, dünne Pilotform-Doppelsteg-Modelle. Cool & trendy. Hightech-Kombifassungen, die richtig in sind. Oder: Mega verkaufstarke Topseller aus Kunststoff oder Metall, immer nachgefragt. Und die Qualität? Unschlagbar!



7980-16



6227-16

” Urban Style – ein Wahnsinns-Feeling. Cool und lässig im Look. “



7982-15



6226-12

LOOK & FEEL
MEN'S EYEWEAR

LOOK & FEEL **7985**

NEU

LOOK & FEEL
EYEWEAR COLLECTION



STAINLESS STEEL
premium selection

Farbe 16 Edelstahl, Federscharnier

Größen 57-18

Farben 08

14

16

57

18

140

39

15



LOOK & FEEL **7984**

NEU

LOOK & FEEL
EYEWEAR COLLECTION



STAINLESS STEEL
premium selection

Farbe 14 Edelstahl, Federscharnier, Kunststoffbügel

Größen 53-17

Farben 08

14

15

16

53

17

140

31

17



LOOK & FEEL **7983**

NEU

LOOK & FEEL
EYEWEAR COLLECTION



STAINLESS STEEL
premium selection

Farbe 14 Edelstahl, Federscharnier, Kunststoffbügel

Größen 53-18

Farben 10

14

16

53

18

140

34

19



LOOK & FEEL **7982**

NEU

LOOK & FEEL
EYEWEAR COLLECTION



STAINLESS STEEL
premium selection

Farbe 16 Edelstahl, Federscharnier, Kunststoffbügel

Größen 55-18

Farben 02

14

15

16

55

18

140

34

19



» Look & Feel Herren Metall-, Cell-, Beflex- und Clip-on-Fassungen

LOOK & FEEL **7981**

NEU

LOOK & FEEL
EYEWEAR COLLECTION



STAINLESS STEEL
premium selection

Farbe 15 Edelstahl, Federscharnier, Kunststoffbügel

Größen 54-17
Farben 08

- 14
- 15
- 16
- 54
- 17
- 140
- 35
- 16

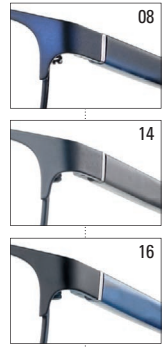

LOOK & FEEL **7980**

NEU

LOOK & FEEL
EYEWEAR COLLECTION



STAINLESS STEEL
premium selection

Farbe 16 Edelstahl, Federscharnier, Kunststoffbügel

Größen 57-18
Farben 08

- 10
- 16
- 57
- 18
- 140
- 37
- 18

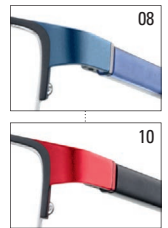

LOOK & FEEL **7979**

LOOK & FEEL
EYEWEAR COLLECTION



STAINLESS STEEL
premium selection

Farbe 14 Edelstahl, Federscharnier, Kunststoffbügel

Größen 55-19
Farben 08

- 14
- 16
- 55
- 19
- 140
- 39
- 18

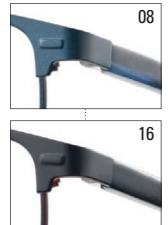

LOOK & FEEL **7978**

LOOK & FEEL
EYEWEAR COLLECTION



STAINLESS STEEL
premium selection

Farbe 14 Edelstahl, Kunststoffbügel

Größen 53-17
Farben 01

- 14
- 16
- 53
- 17
- 140
- 38
- 15

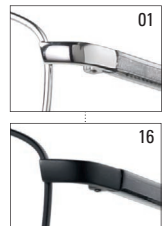

» Look & Feel Herren Metall-, Cell-, Beflex- und Clip-on-Fassungen

LOOK & FEEL **7977**



LOOK & FEEL
EYEWEAR COLLECTION

Größen 54-16

Farben 01

02

16

54

16

140

44

14



01



16

Farbe 02 Edelstahl, Kunststoffbügel

STAINLESS STEEL
premium selection

LOOK & FEEL **7976**



LOOK & FEEL
EYEWEAR COLLECTION

Größen 54-16

Farben 01

02

08

16

54

16

140

43

14



01



02



16

Farbe 08 Edelstahl

STAINLESS STEEL
premium selection

LOOK & FEEL **7974**



LOOK & FEEL
EYEWEAR COLLECTION

Größen 58-17

Farben 08

14

16

58

17

145

36

17



08

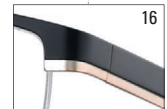

16

Farbe 14 Edelstahl, Federscharnier

STAINLESS STEEL
premium selection

LOOK & FEEL **7973**



LOOK & FEEL
EYEWEAR COLLECTION

Größen 60-17

Farben 02

08

14

60

17

145

36

17



08



14

Farbe 02 Edelstahl, Federscharnier, Kunststoffbügel

STAINLESS STEEL
premium selection

» Look & Feel Herren Metall-, Cell-, Beflex- und Clip-on-Fassungen

LOOK & FEEL **7972**

LOOK & FEEL
EYEWEAR COLLECTION



STAINLESS STEEL
premium selection

Farbe 08 Edelstahl, Federscharnier

- Größen 58-18
60-18
Farben 08
12
14
58/60
18
145
38/40
17

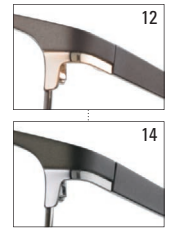

LOOK & FEEL **7971**

LOOK & FEEL
EYEWEAR COLLECTION



STAINLESS STEEL
premium selection

Farbe 14 Edelstahl, Federscharnier

- Größen 57-19
Farben 08
12
14
57
19
140
38
16

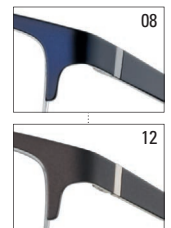

LOOK & FEEL **7970**

LOOK & FEEL
EYEWEAR COLLECTION



STAINLESS STEEL
premium selection

Farbe 08 Edelstahl, Federscharnier

- Größen 54-18
Farben 08
14
16
54
18
140
38
17

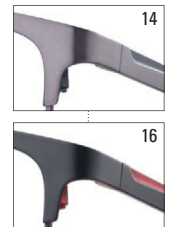

LOOK & FEEL **7969**

LOOK & FEEL
EYEWEAR COLLECTION



STAINLESS STEEL
premium selection

Farbe 16 Edelstahl, Federscharnier, Kunststoffbügel

- Größen 55-17
Farben 08
14
16
55
17
140
37
18

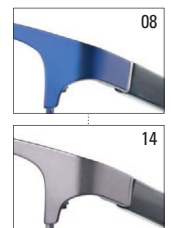

LOOK & FEEL 7968



LOOK & FEEL
EYEWEAR COLLECTION

- Größen 53-18
Farben 08
14
16
53
18
140
45
18

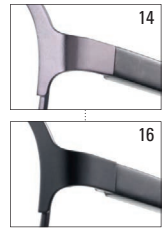

STAINLESS STEEL
premium selection

Farbe 08 Edelstahl, Federscharnier, Kunststoffbügel

LOOK & FEEL 7964



LOOK & FEEL
EYEWEAR COLLECTION

- Größen 57-19
Farben 08
12
14
57
19
140
38
16

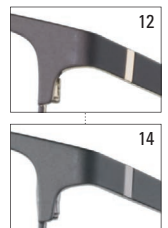

STAINLESS STEEL
premium selection
MAGNETIC CLIP-ON
polarized lenses

Farbe 08 Edelstahl, Federscharnier, Magnet-Clip-On



Gewicht ohne Clip
inkl. Etui

LOOK & FEEL 7963



LOOK & FEEL
EYEWEAR COLLECTION

- Größen 55-17
Farben 08
14
16
55
17
140
37
16

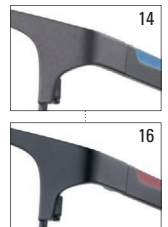

STAINLESS STEEL
premium selection
MAGNETIC CLIP-ON
polarized lenses

Farbe 08 Edelstahl, Federscharnier, Magnet-Clip-On



Gewicht ohne Clip
inkl. Etui

LOOK & FEEL 7962



LOOK & FEEL
EYEWEAR COLLECTION

- Größen 54-18
Farben 08
14
16
54
18
140
38
18

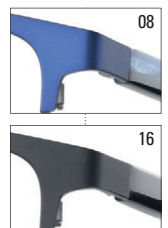

STAINLESS STEEL
premium selection
MAGNETIC CLIP-ON
polarized lenses

Farbe 14 Edelstahl, Federscharnier, Kunststoffbügel,
Magnet-Clip-On



Gewicht ohne Clip
inkl. Etui

» Look & Feel Herren Metall-, Cell-, Beflex- und Clip-on-Fassungen

LOOK & FEEL 7961



LOOK & FEEL
EYEWEAR COLLECTION

STAINLESS STEEL
premium selection
MAGNETIC CLIP-ON
polarized lenses

Größen 59-18

Farben 08

12

14

16

59

18

145

39

20

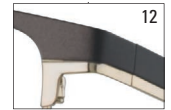

Farbe 16 Edelstahl, Federscharnier, Magnet-Clip-On



Gewicht ohne Clip
inkl. Etui

LOOK & FEEL 7960



LOOK & FEEL
EYEWEAR COLLECTION

STAINLESS STEEL
premium selection

Größen 56-18

Farben 08

12

14

56

18

140

36

17



Farbe 12 Edelstahl, Federscharnier, Kunststoffbügel

LOOK & FEEL 7959



LOOK & FEEL
EYEWEAR COLLECTION

STAINLESS STEEL
premium selection

Größen 57-18

Farben 08

12

14

57

18

140

34

17



Farbe 12 Edelstahl, Federscharnier, Kunststoffbügel

LOOK & FEEL 7958



LOOK & FEEL
EYEWEAR COLLECTION

STAINLESS STEEL
premium selection

Größen 55-17

Farben 08

14

15

55

17

140

37

16



Farbe 14 Edelstahl, Federscharnier, Kunststoffbügel

» Look & Feel Herren Metall-, Cell-, Beflex- und Clip-on-Fassungen

LOOK & FEEL **7957**

LOOK & FEEL
EYEWEAR COLLECTION



STAINLESS STEEL
premium selection

- Größen 52-19
Farben 08
14
16
52
19
140
33
15

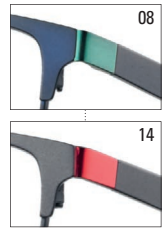

Farbe 16 Edelstahl, Federscharnier

LOOK & FEEL **7956**

LOOK & FEEL
EYEWEAR COLLECTION



STAINLESS STEEL
premium selection

- Größen 57-18
Farben 08
14
16
57
18
140
34
17

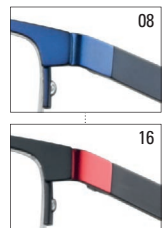

Farbe 14 Edelstahl, Federscharnier

LOOK & FEEL **7955**

LOOK & FEEL
EYEWEAR COLLECTION



STAINLESS STEEL
premium selection

- Größen 56-17
Farben 08
14
16
56
17
140
35
11

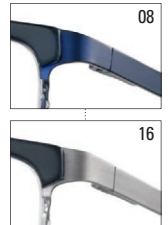

Farbe 14 Edelstahl, Federscharnier, Kombifassung

LOOK & FEEL **7954**

LOOK & FEEL
EYEWEAR COLLECTION



BEFLEX
STAINLESS STEEL

- Größen 50-17
Farben 08
14
16
50
17
135
30
13

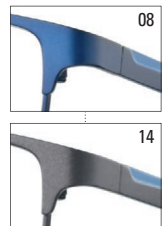

Farbe 16 Edelstahl, Federscharnier, BEFLEX Memorybrücke

» Look & Feel Herren Metall-, Cell-, Beflex- und Clip-on-Fassungen

LOOK & FEEL **7953**

LOOK & FEEL
EYEWEAR COLLECTION



- Größen 57-18
Farben 08
14
16
57
18
140
37
16

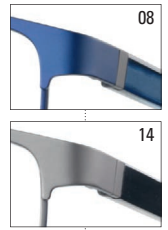

Farbe 16 Edelstahl, Federscharnier, Kunststoffbügel, BEFLEX Memorybrücke

LOOK & FEEL **7952**

LOOK & FEEL
EYEWEAR COLLECTION



- Größen 52-17
Farben 08
14
16
52
17
140
32
15

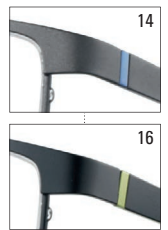

Farbe 08 Edelstahl, Federscharnier, BEFLEX Memorybrücke

LOOK & FEEL **7951**

LOOK & FEEL
EYEWEAR COLLECTION



- Größen 54-17
Farben 08
14
16
54
17
140
32
15

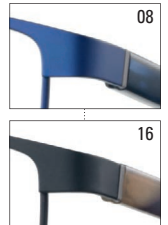

Farbe 14 Edelstahl, Federscharnier, Kunststoffbügel, BEFLEX Memorybrücke

LOOK & FEEL **7950**

LOOK & FEEL
EYEWEAR COLLECTION



- Größen 55-17
Farben 08
14
16
55
17
140
35
15

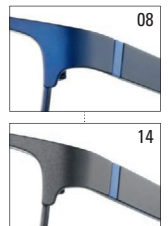

Farbe 16 Edelstahl, Federscharnier, BEFLEX Memorybrücke

LOOK & FEEL **7949**

LOOK & FEEL
EYEWEAR COLLECTION



- Größen 58-18
Farben 08
14
16
58
18
140
37
15

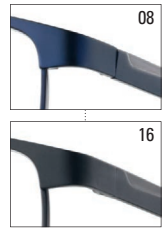

Farbe 14 Edelstahl, Federscharnier, BEFLEX Memorybrücke

LOOK & FEEL **7944**

LOOK & FEEL
EYEWEAR COLLECTION



- Größen 58-18
Farben 08
12
14
58
18
140
36
16

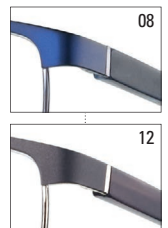

Farbe 14 Edelstahl, Federscharnier, Kunststoffbügel

LOOK & FEEL **7943**

LOOK & FEEL
EYEWEAR COLLECTION



- Größen 54-18
Farben 08
14
16
54
18
140
35
15

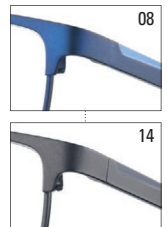

Farbe 16 Edelstahl, Federscharnier

LOOK & FEEL **7942**

LOOK & FEEL
EYEWEAR COLLECTION



- Größen 55-17
Farben 12
14
16
55
17
140
33
15

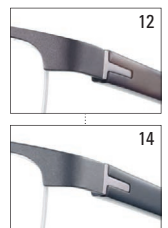

Farbe 16 Edelstahl, Federscharnier, Kunststoffbügel

» Look & Feel Herren Metall-, Cell-, Beflex- und Clip-on-Fassungen

LOOK & FEEL **7941**

LOOK & FEEL
EYEWEAR COLLECTION



- Größen 54-17
Farben 08
14
16
54
17
140
32
14

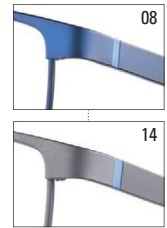

STAINLESS STEEL
premium selection

Farbe 16 Edelstahl, Federscharnier

LOOK & FEEL **7940**

LOOK & FEEL
EYEWEAR COLLECTION



- Größen 54-17
Farben 08
14
16
54
17
140
34
16

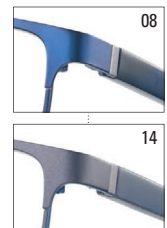

STAINLESS STEEL
premium selection

Farbe 16 Edelstahl, Federscharnier, Kunststoffbügel

LOOK & FEEL **7939**

LOOK & FEEL
EYEWEAR COLLECTION



- Größen 57-17
Farben 08
14
16
57
17
140
36
15

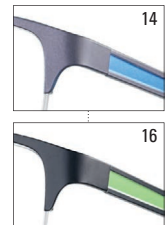

STAINLESS STEEL
premium selection

Farbe 08 Edelstahl, Federscharnier

LOOK & FEEL **7938**

LOOK & FEEL
EYEWEAR COLLECTION



- Größen 57-18
Farben 08
14
16
57
18
140
37
15

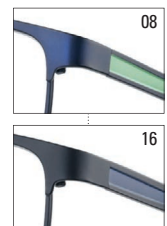

STAINLESS STEEL
premium selection

Farbe 14 Edelstahl, Federscharnier

» Look & Feel Herren Metall-, Cell-, Beflex- und Clip-on-Fassungen

LOOK & FEEL **7926**

LOOK & FEEL
EYEWEAR COLLECTION



- Größen 53-17
Farben 08
12
16
53
17
140
32
18

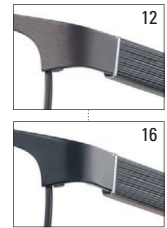

STAINLESS STEEL
premium selection

Farbe 08 Edelstahl, Federscharnier, Kunststoffbügel

LOOK & FEEL **7923**

LOOK & FEEL
EYEWEAR COLLECTION



- Größen 55-19
Farben 08
14
16
55
19
140
34
17

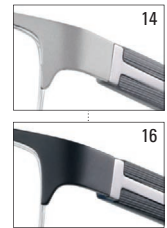

STAINLESS STEEL
premium selection

Farbe 08 Edelstahl, Federscharnier, Kunststoffbügel

LOOK & FEEL **7919**

LOOK & FEEL
EYEWEAR COLLECTION



- Größen 56-16
Farben 08
14
16
56
16
140
34
14

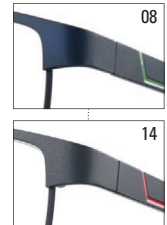

STAINLESS STEEL
premium selection

Farbe 16 Edelstahl, Federscharnier

LOOK & FEEL **7918**

LOOK & FEEL
EYEWEAR COLLECTION



- Größen 55-17
Farben 08
14
16
55
17
140
34
18

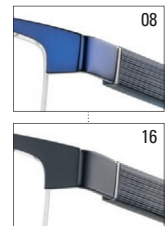

STAINLESS STEEL
premium selection

Farbe 14 Edelstahl, Federscharnier, Kunststoffbügel

» Look & Feel Herren Metall-, Cell-, Beflex- und Clip-on-Fassungen

LOOK & FEEL 7915

LOOK & FEEL
EYEWEAR COLLECTION



- Größen 56-18
Farben 08
14
16
56
18
140
36
16

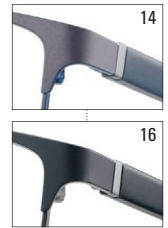

Farbe 08 Edelstahl, Federscharnier, Kunststoffbügel

STAINLESS STEEL
premium selection

LOOK & FEEL 7914

LOOK & FEEL
EYEWEAR COLLECTION



- Größen 46-20
Farben 12
14
16
46
20
140
38
12

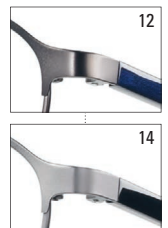

Farbe 16 Edelstahl, Kunststoffbügel

STAINLESS STEEL
premium selection

LOOK & FEEL 7910

LOOK & FEEL
EYEWEAR COLLECTION



- Größen 58-18
Farben 08
12
14
58
18
140
36
19

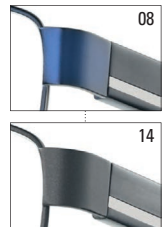

Farbe 12 Edelstahl, Federscharnier, Kunststoffbügel

STAINLESS STEEL
premium selection

LOOK & FEEL 7909

LOOK & FEEL
EYEWEAR COLLECTION



- Größen 54-18
Farben 08
16
54
18
140
33
16



Farbe 08 Edelstahl, Federscharnier, Kunststoffbügel

STAINLESS STEEL
premium selection

» Look & Feel Herren Metall-, Cell-, Beflex- und Clip-on-Fassungen

LOOK & FEEL **7882**

LOOK & FEEL
EYEWEAR COLLECTION



- Größen 57-18
Farben 08
14
57
18
140
35
20



Farbe 08 Edelstahl, Federscharnier, Kunststoffbügel

STAINLESS STEEL
premium selection

LOOK & FEEL **7881**

LOOK & FEEL
EYEWEAR COLLECTION



- Größen 57-18
Farben 12
16
57
18
140
37
20



Farbe 16 Edelstahl, Federscharnier, Kunststoffbügel

STAINLESS STEEL
premium selection

LOOK & FEEL **7852**

LOOK & FEEL
EYEWEAR COLLECTION



- Größen 55-18
Farben 12
14
16
55
18
140
33
11



Farbe 14 Edelstahl

STAINLESS STEEL
premium selection

LOOK & FEEL **7808**

LOOK & FEEL
EYEWEAR COLLECTION



- Größen 59-18
Farben 12
14
16
59
18
145
37
21



Farbe 12 Edelstahl, Federscharnier, Kunststoffbügel

STAINLESS STEEL
premium selection

LOOK & FEEL **7800**



LOOK & FEEL
EYEWEAR COLLECTION

- Größen 58-18
Farben 08
12
14
58
18
140
36
22

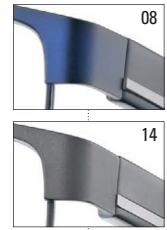

Farbe 12 Edelstahl, Federscharnier, Kunststoffbügel

STAINLESS STEEL
premium selection

men **7798**



LOOK & FEEL
EYEWEAR COLLECTION

- Größen 58-17
60-17
Farben 12
14
58/60
17
140/145
38/40
19



Farbe 14 Edelstahl, Federscharnier

STAINLESS STEEL
premium selection

LOOK & FEEL **6231**

NEU



LOOK & FEEL
EYEWEAR COLLECTION

XTRA LIGHT ACETATE
premium selection
MAGNETIC CLIP-ON
polarized lenses

- Größen 49-16
Farben 08
15
16
49
16
135
30
14

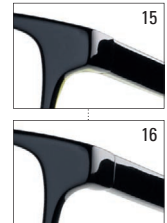

Farbe 08 Zelluloseacetat, Federscharnier, Magnet-Clip-On



Gewicht ohne Clip
inkl. Etui

LOOK & FEEL **6230**

NEU



LOOK & FEEL
EYEWEAR COLLECTION

- Größen 54-18
Farben 08
15
16
54
18
140
33
13

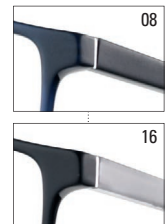

Farbe 15 Zelluloseacetat, Federscharnier, Stegstütze

XTRA LIGHT ACETATE
premium selection

LOOK & FEEL 6228

NEU

LOOK & FEEL
EYEWEAR COLLECTION



XTRA LIGHT ACETATE
premium selection

- Größen 57-16
Farben 08
12
16
57
16
145
40
12

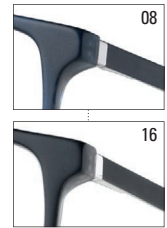

Farbe 12 Zelluloseacetat, Federscharnier, Metallbügel

LOOK & FEEL 6227

NEU

LOOK & FEEL
EYEWEAR COLLECTION



XTRA LIGHT ACETATE
premium selection

- Größen 55-16
Farben 08
14
16
55
16
145
40
12

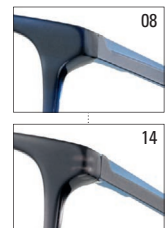

Farbe 16 Zelluloseacetat, Federscharnier, Metallbügel

LOOK & FEEL 6226

NEU

LOOK & FEEL
EYEWEAR COLLECTION



XTRA LIGHT ACETATE
premium selection

- Größen 47-18
Farben 08
12
14
16
47
18
140
40
11

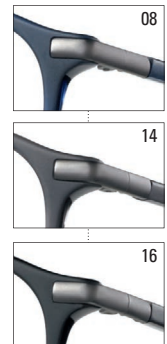

Farbe 12 Zelluloseacetat

LOOK & FEEL 6225

NEU

LOOK & FEEL
EYEWEAR COLLECTION



XTRA LIGHT ACETATE
premium selection

- Größen 52-18
Farben 08
14
15
16
52
18
140
40
13

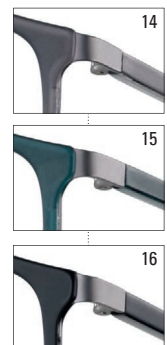

Farbe 08 Zelluloseacetat, Edelstahl, Kombifassung

» Look & Feel Herren Metall-, Cell-, Beflex- und Clip-on-Fassungen

LOOK & FEEL 6221



LOOK & FEEL
EYEWEAR COLLECTION

Größen 53-18

Farben 08

12

14

16

53

18

140

37

14

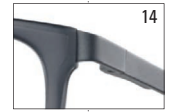

XTRA LIGHT ACETATE
premium selection

Farbe 08 Zelluloseacetat, Edelstahl, Federscharnier, Kombifassung

LOOK & FEEL 6220



LOOK & FEEL
EYEWEAR COLLECTION

Größen 59-18

Farben 08

12

14

16

59

18

150

39

16



XTRA LIGHT ACETATE
premium selection

Farbe 14 Zelluloseacetat, Federscharnier

LOOK & FEEL 6217



LOOK & FEEL
EYEWEAR COLLECTION

Größen 54-17

Farben 08

12

16

54

17

140

39

14



XTRA LIGHT ACETATE
premium selection
MAGNETIC CLIP-ON
polarized lenses



Gewicht ohne Clip
inkl. Etui

Farbe 08 Zelluloseacetat, Federscharnier, Magnet-Clip-On

LOOK & FEEL 6216



LOOK & FEEL
EYEWEAR COLLECTION

Größen 49-20

Farben 10

12

16

49

20

140

40

13



XTRA LIGHT ACETATE
premium selection
MAGNETIC CLIP-ON
polarized lenses



Gewicht ohne Clip
inkl. schwarzem
Magnet-Sonnenclip

Farbe 16 Zelluloseacetat, Federscharnier

» Look & Feel Herren Metall-, Cell-, Beflex- und Clip-on-Fassungen

LOOK & FEEL 6215



LOOK & FEEL
EYEWEAR COLLECTION

Größen 53-16

Farben 08

11

14

16

53

16

145

40

11

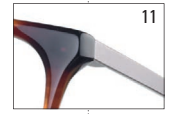

Farbe 14 Zelluloseacetat, Metallbügel

XTRA LIGHT ACETATE
premium selection

LOOK & FEEL 6213



LOOK & FEEL
EYEWEAR COLLECTION

Größen 56-15

Farben 08

12

16

56

15

145

36

11



Farbe 08 Zelluloseacetat, Metallbügel

XTRA LIGHT ACETATE
premium selection

LOOK & FEEL 6211



LOOK & FEEL
EYEWEAR COLLECTION

Größen 55-15

Farben 08

12

16

55

15

140

37

13

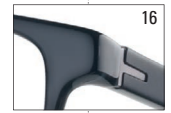

Farbe 12 Zelluloseacetat, Federscharnier

XTRA LIGHT ACETATE
premium selection
MAGNETIC CLIP-ON
polarized lenses



Gewicht ohne Clip

inkl. schwarzem
Magnet-Sonnenclip

LOOK & FEEL 6210



LOOK & FEEL
EYEWEAR COLLECTION

Größen 57-15

Farben 08

12

16

57

15

140

37

14



Farbe 16 Zelluloseacetat, Federscharnier

XTRA LIGHT ACETATE
premium selection
MAGNETIC CLIP-ON
polarized lenses



Gewicht ohne Clip

inkl. schwarzem
Magnet-Sonnenclip

» Look & Feel Herren Metall-, Cell-, Beflex- und Clip-on-Fassungen

LOOK & FEEL 6209



LOOK & FEEL
EYEWEAR COLLECTION

XTRA LIGHT ACETATE
premium selection

MAGNETIC CLIP-ON
polarized lenses

Größen 55-16

Farben 08

12

16

55

16

140

37

13

Gewicht ohne Clip

inkl. schwarzem
Magnet-Sonnenclip

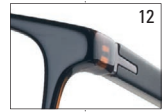

Farbe 16 Zelluloseacetat, Federscharnier



LOOK & FEEL 6192



LOOK & FEEL
EYEWEAR COLLECTION

XTRA LIGHT ACETATE
premium selection

Größen 56-16

Farben 08

16

56

16

145

40

16



Farbe 16 Zelluloseacetat, Federscharnier

LOOK & FEEL 6190



LOOK & FEEL
EYEWEAR COLLECTION

XTRA LIGHT ACETATE
premium selection

Größen 54-15

Farben 08

10

16

54

15

140

34

14



Farbe 10 Zelluloseacetat, Federscharnier

LOOK & FEEL 6188



LOOK & FEEL
EYEWEAR COLLECTION

XTRA LIGHT ACETATE
premium selection

Größen 54-16

Farben 08

12

14

54

16

140

32

16



Farbe 08 Zelluloseacetat, Federscharnier

LOOK & FEEL 6185

LOOK & FEEL
EYEWEAR COLLECTION



- Größen 53-17
 Farben 08
 14
 16
 53
 17
 140
 31
 14

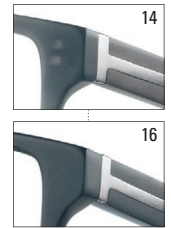

Farbe 08 Zelluloseacetat

XTRA LIGHT ACETATE
premium selection

LOOK & FEEL 6163

LOOK & FEEL
EYEWEAR COLLECTION



- Größen 58-16
 Farben 14
 16
 58
 16
 145
 38
 18



Farbe 16 Zelluloseacetat, Federscharnier, Metallbügel

HAND MADE ACETATE
premium selection

women **8265**

NEU

women
eyewear



STAINLESS STEEL
premium selection

Farbe 16 Edelstahl, Federscharnier

- Größen 54-17
Farben 04
10
16
54
17
135
34
16

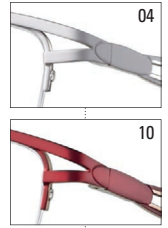

women **8264**

NEU

women
eyewear



STAINLESS STEEL
premium selection

Farbe 12 Edelstahl, Kunststoffbügel

- Größen 54-18
56-18
Farben 04
10
12
54/56
18
135
38/40
17

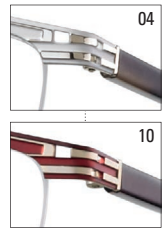

women **8247**

women
eyewear



STAINLESS STEEL
premium selection

Farbe 16 Edelstahl, Federscharnier

- Größen 50-18
Farben 04
12
16
50
18
137
37
14

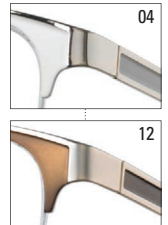

women **8246**

women
eyewear



STAINLESS STEEL
premium selection

Farbe 04 Edelstahl, Federscharnier

- Größen 54-16
56-16
Farben 04
10
16
54/56
16
135/140
38/39
14

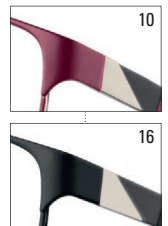

› women Damen Metallfassungen

women **8230**

women
eyewear



STAINLESS STEEL
premium selection

- Größen 53-16
Farben 04
10
12
53
16
135
35
16

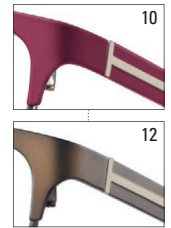

Farbe 04 Edelstahl, Federscharnier

women **8222**

women
eyewear



STAINLESS STEEL
premium selection

- Größen 55-16
Farben 10
12
14
55
16
135
35
14

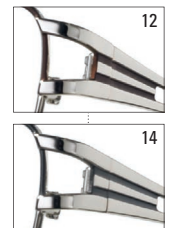

Farbe 10 Edelstahl, Federscharnier

women **8221**

women
eyewear



STAINLESS STEEL
premium selection

- Größen 52-17
Farben 10
12
14
52
17
135
35
14

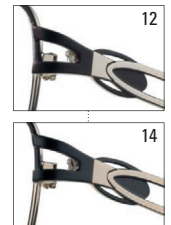

Farbe 10 Edelstahl, Federscharnier

women **8220**

women
eyewear



STAINLESS STEEL
premium selection

- Größen 52-16
54-16
Farben 10
12
52/54
16
135
36/38
15



Farbe 10 Edelstahl, Federscharnier, Kunststoffbügel

women **8190**

women
eyewear



STAINLESS STEEL
premium selection

Farbe 10 Edelstahl, Federscharnier

- Größen 50-17
52-17
Farben 10
12
14
50/52
17
130/135
33/35
12

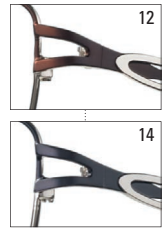

women **8189**

women
eyewear



STAINLESS STEEL
premium selection

Farbe 14 Edelstahl, Federscharnier

- Größen 53-16
Farben 10
12
14
53
16
135
34
13

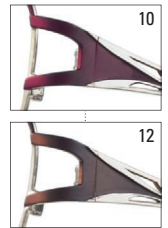

women **8188**

women
eyewear



STAINLESS STEEL
premium selection

Farbe 12 Edelstahl, Federscharnier, Kunststoffbügel

- Größen 54-16
Farben 10
12
15
54
16
135
36
15

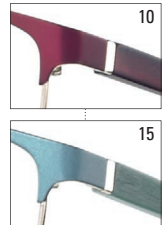

women **8187**

women
eyewear



STAINLESS STEEL
premium selection

Farbe 12 Edelstahl, Federscharnier

- Größen 53-16
Farben 10
12
14
53
16
135
37
14



women **8186**

women
eyewear



STAINLESS STEEL
premium selection

Farbe 10 Edelstahl, Federscharnier

- Größen 49-17
51-17
Farben 10
12
15
49/51
17
130/135
33/35
14

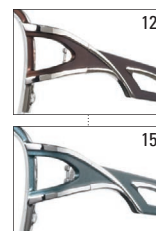

women **8152**

women
eyewear



STAINLESS STEEL
premium selection

Farbe 10 Edelstahl, Federscharnier

- Größen 50-17
52-17
Farben 10
12
14
50/52
17
130/135
34/35
14

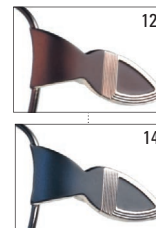

men Herren Metallfassungen

men **7967**

men
eyewear



STAINLESS STEEL
premium selection

- Größen 57-18
59-18
Farben 02
14
57/59
18
140/145
38/39
16

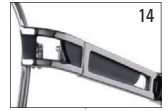

14

Farbe 02 Edelstahl, Federscharnier

men **7966**

men
eyewear



STAINLESS STEEL
premium selection

- Größen 57-18
59-18
Farben 02
14
57/59
18
140/145
38/39
17



02

Farbe 14 Edelstahl, Federscharnier

men **7925**

men
eyewear



STAINLESS STEEL
premium selection

- Größen 54-18
56-18
Farben 02
14
54/56
18
140
37/38
18



02

Farbe 14 Edelstahl, Federscharnier, Kunststoffbügel

men **7924**

men
eyewear



STAINLESS STEEL
premium selection

- Größen 56-17
58-17
Farben 02
14
56/58
17
140/145
37/39
15



14

Farbe 02 Edelstahl, Federscharnier

men Herren Metallfassungen

men **7862**

men
eyewear



STAINLESS STEEL
premium selection

- Größen 54-19
56-19
- Farben 02
14
- 54/56
 - 19
 - 140
 - 36/38
 - 17



14

Farbe 02 Edelstahl, Federscharnier

men **7788**

men
eyewear



STAINLESS STEEL
premium selection

- Größen 50-17
52-17
- Farben 02
14
- 50/52
 - 17
 - 135/140
 - 33/34
 - 10



02

Farbe 14 Edelstahl, Federscharnier

men **7753**

men
eyewear



STAINLESS STEEL
premium selection

- Größen 54-18
56-18
- Farben 02
14
- 54/56
 - 18
 - 140
 - 34/36
 - 14



14

Farbe 02 Edelstahl, Federscharnier



HIPPE BRILLEN FÜR TEENS & TWENS

JUNGE WILDE

Angesagte Brillen für modebewusste junge Leute. Flache, eckige Formen in gefragten Farben für IHN. Runde Formen und nicht zu breite Pantoformen in Trend-Farben für SIE. Mega leichte, dünne xtra-light-Acetat-Modelle mit Federscharnier. Und die Qualität? Stresserprobt. Belastbar! Genau die richtigen für junge Wilde.



2933-08



2930-08

JUMP UP
DIE BRILLE

Jump Up 2937

NEU

JUMP UP
DIE BRILLE



STAINLESS STEEL
premium selection

- Größen 48-17
Farben 08
12
16
48
17
130
35
13

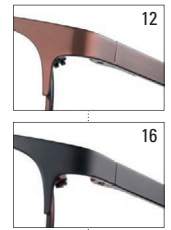

Farbe 08 Edelstahl, Federscharnier

Jump Up 2936

NEU

JUMP UP
DIE BRILLE



STAINLESS STEEL
premium selection

- Größen 49-18
Farben 08
15
16
49
18
130
38
14

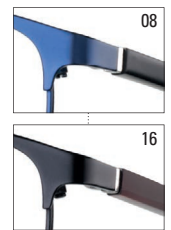

Farbe 15 Edelstahl, Federscharnier, Kunststoffbügel

Jump Up 2934

NEU

JUMP UP
DIE BRILLE



STAINLESS STEEL
premium selection

- Größen 47-17
Farben 08
10
16
47
17
135
37
14

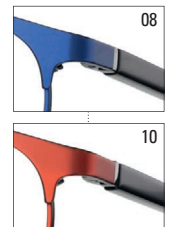

Farbe 16 Edelstahl, Federscharnier, Kunststoffbügel

Jump Up 2933

NEU

JUMP UP
DIE BRILLE



XTRA LIGHT ACETATE
premium selection

- Größen 47-16
Farben 08
11
14
15
47
16
135
38
12



Farbe 08 Zelluloseacetat, Federscharnier

Jump Up 2932

JUMP UP
DIE BRILLE



XTRA LIGHT ACETATE
premium selection

Farbe 08 Zelluloseacetat, Federscharnier, Metallbügel

Größen 48-16

- Farben 08
10
15
16
48
16
135
35
13

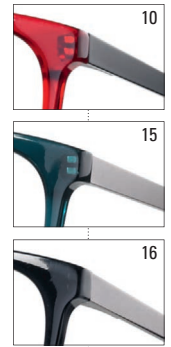

Jump Up 2931

JUMP UP
DIE BRILLE



XTRA LIGHT ACETATE
premium selection

Farbe 08 Zelluloseacetat, Federscharnier

Größen 47-16

- Farben 05
08
16
17
47
16
135
36
17

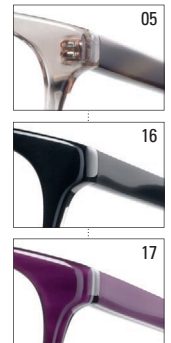

Jump Up 2930

JUMP UP
DIE BRILLE



XTRA LIGHT ACETATE
premium selection

Farbe 16 Zelluloseacetat, Federscharnier

Größen 49-15

- Farben 08
15
16
49
15
135
33
13

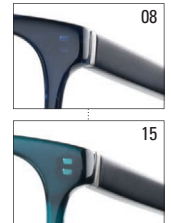

Jump Up 2916

JUMP UP
DIE BRILLE



STAINLESS STEEL
premium selection

Farbe 15 Edelstahl, Federscharnier, Kunststoffbügel

Größen 48-17

- Farben 08
15
16
48
17
137
35
15

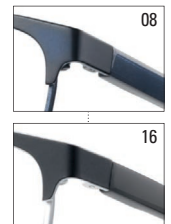

Jump Up und Jump Up Teens

Jump Up 2914



JUMP UP
DIE BRILLE

Größen 48-16

Farben 12

14

15

16

⊖

16

⊖

150

⊖

27

⊖

14



Farbe 15 Zelluloseacetat, Federscharnier

XTRA LIGHT ACETATE
premium selection

Jump Up 2912



JUMP UP
DIE BRILLE

Größen 51-16

Farben 08

14

16

⊖

51

⊖

16

⊖

150

⊖

26

⊖

16



Farbe 08 Zelluloseacetat, Federscharnier

XTRA LIGHT ACETATE
premium selection

Jump Up 2904



JUMP UP
DIE BRILLE

Größen 50-19

Farben 08

14

16

⊖

50

⊖

19

⊖

135

⊖

30

⊖

16



Farbe 08 Edelstahl, Federscharnier

STAINLESS STEEL
premium selection

Jump Up und Jump Up Teens

Jump Up Teens **2903**



JUMP UP
TEENS

- Größen 49-17
 Farben 08
 12
 16
 49
 17
 135
 30
 12

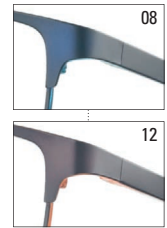

STAINLESS STEEL
premium selection

Farbe 16 Edelstahl, Federscharnier

Jump Up Teens **2899**



JUMP UP
TEENS

- Größen 51-16
 Farben 08
 14
 16
 51
 16
 135
 32
 16

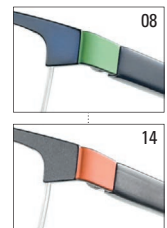

STAINLESS STEEL
premium selection

Farbe 16 Edelstahl, Federscharnier, Kunststoffbügel

Jump Up Teens **2897**



JUMP UP
TEENS

- Größen 51-17
 Farben 08
 14
 16
 51
 17
 135
 30
 14

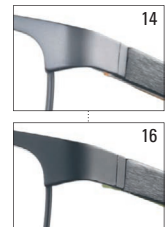

STAINLESS STEEL
premium selection

Farbe 08 Edelstahl, Federscharnier, Kunststoffbügel

Jump Up Teens **2889**



JUMP UP
TEENS

- Größen 49-18
 Farben 08
 16
 49
 18
 135
 30
 16

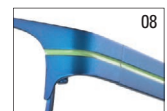

STAINLESS STEEL
premium selection

Farbe 16 Edelstahl, Federscharnier

Jump Up und Jump Up Teens

Jump Up 2887



JUMP UP
DIE BRILLE

Größen 50-16

Farben 10

12



50



16



130



34



15

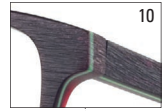

HAND MADE ACETATE
premium selection

Farbe 12 Zelluloseacetat, Federscharnier

Jump Up Teens 2880



JUMP UP
TEENS

Größen 48-16

Farben 08

14



48



16



135



29



16



STAINLESS STEEL
premium selection

Farbe 14 Edelstahl, Federscharnier, Kunststoffbügel



MODERNE, FARBENFROHE KINDERBRILLEN

COOLE KIDS



4285-17

Neue Kinderbrillen mit modernen und kindgerechten Formen. In lebendigen, fröhlichen Farben. Gute Qualität: stabil und belastbar. Und der Preis? Super günstig! Ordern Sie jetzt neue, preiswerte Kinderbrillen zum sensationellen Einkaufspreis und bieten Sie diese zum attraktiven Verkaufspreis an. 1A-Margen. Starke Brillen für crazy Jungs und Mädchen.



4291-10



4290-08

KID'S ONE[®]

Kids One **4291**

NEU

KID'S ONE®



STAINLESS STEEL
premium selection

Größen 45-16

Farben 08

10

15

16

45

16

130

35

13

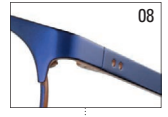

08

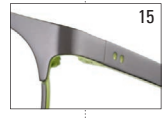

15



16

Farbe 10 Edelstahl, Federscharnier

Kids One **4290**

NEU

KID'S ONE®



XTRA LIGHT ACETATE
premium selection

Größen 44-16

Farben 08

10

17

44/46

16

125/130

33/34

11

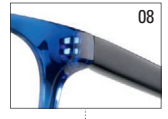

08



17

Farbe 10 Zelluloseacetat, Federscharnier

Kids One **4289**

NEU

KID'S ONE®



STAINLESS STEEL
premium selection

Größen 45-16

Farben 10

17

45/47

16

125/130

31/32

13



10

Farbe 17 Edelstahl, Federscharnier, Kunststoffbügel

Kids One **4288**

NEU

KID'S ONE®



STAINLESS STEEL
premium selection

Größen 45-16

Farben 08

16

45/47

16

125/130

30/31

13



16

Farbe 08 Edelstahl, Federscharnier, Kunststoffbügel

Kids One **4287**

NEU

KID'S ONE®



- Größen 45-16
47-16
Farben 08
16
⊖ 45/47
⊗ 16
⌒ 130/135
Ⓢ 26/27
Ⓜ 13



Farbe 16 Zelluloseacetat, Federscharnier

Kids One **4286**

NEU

KID'S ONE®



- Größen 39-17
Farben 08
17
⊖ 39
⊗ 17
⌒ 120
Ⓢ 27
Ⓜ 12



Farbe 17 Zelluloseacetat, Federscharnier

Kids One **4285**

NEU

KID'S ONE®



- Größen 41-17
Farben 08
17
⊖ 41
⊗ 17
⌒ 120
Ⓢ 32
Ⓜ 13



Farbe 08 Zelluloseacetat, Federscharnier

Kids One **4284**

KID'S ONE®



- Größen 45-16
47-16
Farben 05
08
17
⊖ 45/47
⊗ 16
⌒ 130
Ⓢ 30/32
Ⓜ 12



Farbe 17 Zelluloseacetat, Federscharnier, OBE-Präzisionsscharnier

Kids One **4283**

KID'S ONE®



XTRA LIGHT ACETATE
premium selection

- Größen 45-15
47-15
Farben 08
10
17
⊖ 45/47
⊕ 15
⌒ 130
⌚ 32/33
⌚ 14

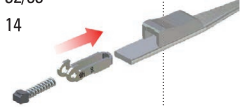
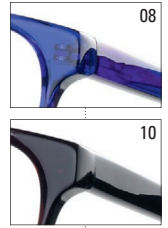

Farbe 17 Zelluloseacetat, Federscharnier, OBE-Präzisionsscharnier

TOP PREIS LEISTUNG

Kids One **4282**

KID'S ONE®



HAND MADE ACETATE
premium selection

- Größen 45-16
47-16
Farben 05
10
17
⊖ 45/47
⊕ 16
⌒ 125/130
⌚ 29/31
⌚ 14

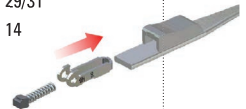
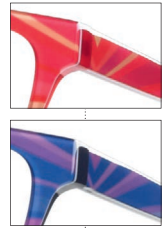

Farbe 05 Zelluloseacetat, Federscharnier, OBE-Präzisionsscharnier

TOP PREIS LEISTUNG

Kids One **4281**

KID'S ONE®



HAND MADE ACETATE
premium selection

- Größen 43-16
45-16
Farben 08
10
16
17
⊖ 43/45
⊕ 16
⌒ 120/125
⌚ 34/36
⌚ 13

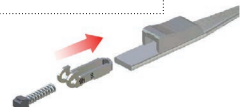
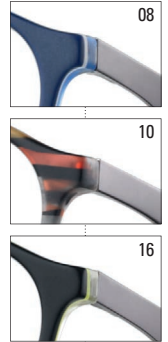

Farbe 17 Zelluloseacetat, Metallbügel, Federscharnier, OBE-Präzisionsscharnier

Kids One **4279**

KID'S ONE®



STAINLESS STEEL
premium selection

- Größen 45-16
47-16
Farben 10
17
⊖ 45/47
⊕ 16
⌒ 125/130
⌚ 29/30
⌚ 15

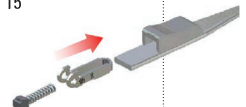

Farbe 17 Edelstahl, Federscharnier, OBE-Präzisionsscharnier, Kunststoffbügel

Kids One **4277**



STAINLESS STEEL
premium selection

- Größen 42-16
44-16
Farben 08
10
⊖ 42/44
⊗ 16
⌒ 120/125
Ⓢ 33/35
Ⓜ 16

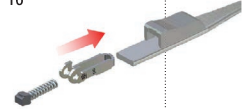

Farbe 10 Edelstahl, Federscharnier, OBE-Präzisionsscharnier, Kunststoffbügel

Kids One **4271**



HAND MADE ACETATE
premium selection

- Größen 45-16
47-16
Farben 07
08
16
⊖ 45/47
⊗ 16
⌒ 125/130
Ⓢ 28/29
Ⓜ 15

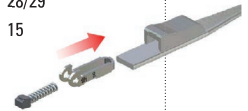

Farbe 08 Zelluloseacetat, Federscharnier, OBE-Präzisionsscharnier

Kids One **4270**



STAINLESS STEEL
premium selection

- Größen 44-17
46-17
Farben 08
14
15
⊖ 44/46
⊗ 17
⌒ 120/125
Ⓢ 28/29
Ⓜ 14

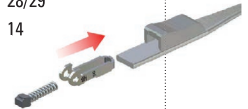
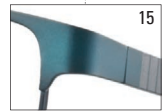

Farbe 08 Edelstahl, Federscharnier, OBE-Präzisionsscharnier

Kids One **4268**



STAINLESS STEEL
premium selection

- Größen 45-17
47-17
Farben 08
16
⊖ 45/47
⊗ 17
⌒ 120/125
Ⓢ 27/28
Ⓜ 15

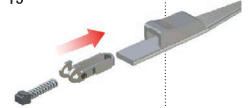

Farbe 16 Edelstahl, Federscharnier, OBE-Präzisionsscharnier

› **WICHTIGE SERVICE-INFORMATIONEN**
zum OBE-Federscharnier (flexUno)



Modellreihe flexUno 2.7: BI 4271, BI 4272, BI 4273, BI 4277, BI 4278, BI 4279, BI 4280, BI 4281, BI 4282

Modellreihe flexUno 3.0: BI 4266, BI 4267, BI 4268, BI 4269, BI 4270, BI 4283, BI 4284

Entriegeln

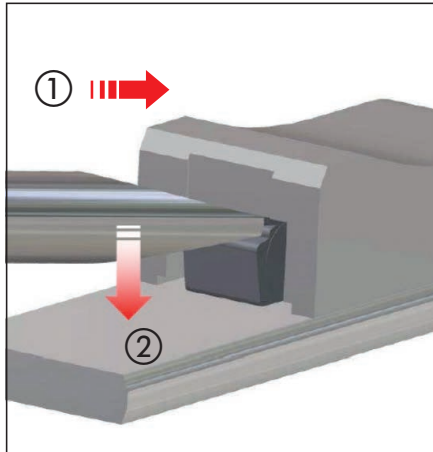

Montage

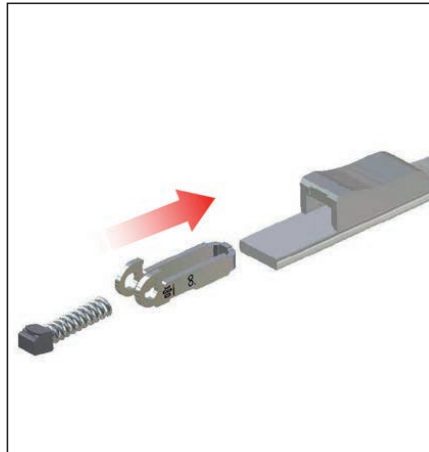

Verriegeln

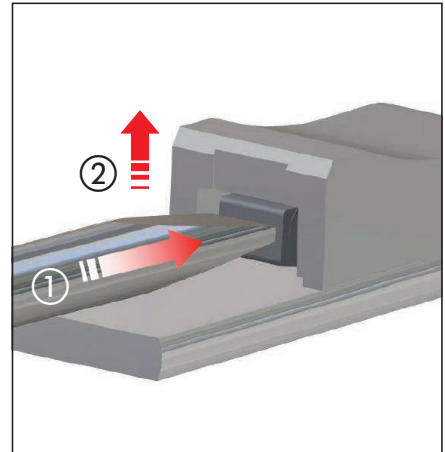

Skylight **3119**

NEU

SKYLIGHT
TITANIUM EYEWEAR



BETA-TITANIUM
Nickel Allergy Free

Farbe 08 Beta Titan, Federscharnier

- Größen 55-18
Farben 08
14
16
55
18
140
34
12

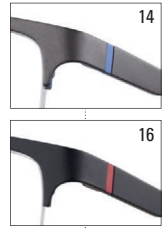

Skylight **3118**

NEU

SKYLIGHT
TITANIUM EYEWEAR



BETA-TITANIUM
Nickel Allergy Free

Farbe 16 Beta Titan, Federscharnier

- Größen 54-17
Farben 08
14
16
54
17
140
33
10

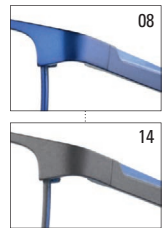

Skylight **3117**

NEU

SKYLIGHT
TITANIUM EYEWEAR



BETA-TITANIUM
Nickel Allergy Free

Farbe 12 Beta Titan, Federscharnier

- Größen 56-16
Farben 08
12
14
56
16
140
37
10

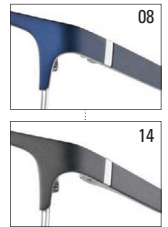

Skylight **3116**

NEU

SKYLIGHT
TITANIUM EYEWEAR



BETA-TITANIUM
Nickel Allergy Free

Farbe 15 Beta Titan, Federscharnier

- Größen 52-17
Farben 06
10
15
16
52
17
135
36
10

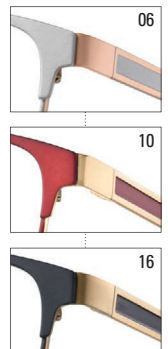

Skylight Titan

Skylight **3115**

NEU

SKYLIGHT
TITANIUM EYEWEAR



BETA-TITANIUM
Nickel Allergy Free

- Größen 52-17
Farben 04
10
16
52
17
135
35
12

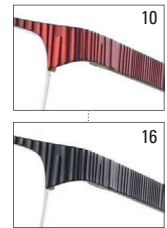

Farbe 04 Beta Titan, Federscharnier

Skylight **3114**

NEU

SKYLIGHT
TITANIUM EYEWEAR



BETA-TITANIUM
Nickel Allergy Free

- Größen 54-16
Farben 04
12
16
54
16
135
37
9

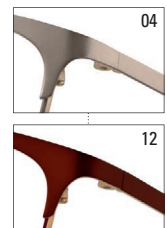

Farbe 16 Beta Titan

Skylight **3113**

SKYLIGHT
TITANIUM EYEWEAR



BETA-TITANIUM
Nickel Allergy Free

- Größen 57-18
Farben 08
14
16
57
18
140
36
14

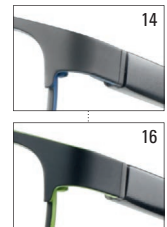

Farbe 08 Beta Titan, Federscharnier, Kunststoffbügel

Skylight **3112**

SKYLIGHT
TITANIUM EYEWEAR



BETA-TITANIUM
Nickel Allergy Free

- Größen 49-17
Farben 12
15
17
49
17
130
33
10

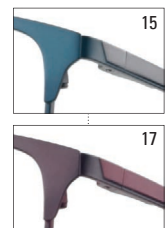

Farbe 12 Beta Titan, Federscharnier

Skylight **3111**



SKYLIGHT
TITANIUM EYEWEAR

- Größen 53-16
 Farben 08
 12
 16
 53
 16
 135
 35
 11

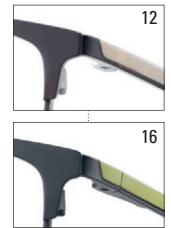

BETA-TITANIUM
Nickel Allergy Free

Farbe 08 Beta Titan, Federscharnier

Skylight **3110**



SKYLIGHT
TITANIUM EYEWEAR

- Größen 48-18
 Farben 12
 15
 16
 48
 18
 135
 39
 9

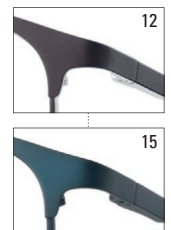

BETA-TITANIUM
Nickel Allergy Free

Farbe 16 Beta Titan, Federscharnier

Skylight **3109**



SKYLIGHT
TITANIUM EYEWEAR

- Größen 50-17
 Farben 10
 12
 14
 50
 17
 135
 35
 9

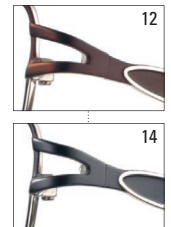

BETA-TITANIUM
Nickel Allergy Free

Farbe 10 Beta Titan, Federscharnier

Skylight **3108**



SKYLIGHT
TITANIUM EYEWEAR

- Größen 54-16
 Farben 10
 12
 15
 54
 16
 135
 38
 11

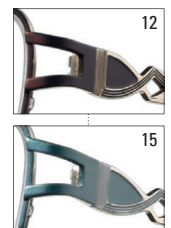

BETA-TITANIUM
Nickel Allergy Free

Farbe 10 Beta Titan, Federscharnier

Skylight **3107**



SKYLIGHT
TITANIUM EYEWEAR

BETA-TITANIUM
Nickel Allergy Free

- Größen 52-17
Farben 10
12
14
52
17
135
36
09

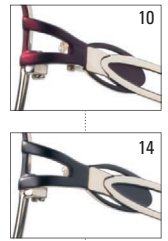

Farbe 12 Beta Titan, Federscharnier

Skylight **3106**



SKYLIGHT
TITANIUM EYEWEAR

BETA-TITANIUM
Nickel Allergy Free

- Größen 55-16
Farben 08
12
16
55
16
140
38
12

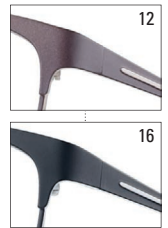

Farbe 08 Beta Titan, Federscharnier

Skylight **3105**



SKYLIGHT
TITANIUM EYEWEAR

BETA-TITANIUM
Nickel Allergy Free

- Größen 54-16
Farben 12
16
17
54
16
135
35
10

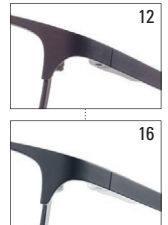

Farbe 17 Beta Titan, Federscharnier

Skylight **3104**



SKYLIGHT
TITANIUM EYEWEAR

BETA-TITANIUM
Nickel Allergy Free

- Größen 49-17
Farben 10
12
16
49
17
135
35
10

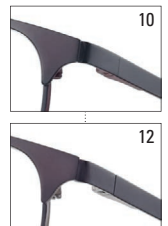

Farbe 16 Beta Titan, Federscharnier

Skylight **3103**



SKYLIGHT
TITANIUM EYEWEAR

BETA-TITANIUM
Nickel Allergy Free

- Größen 53-16
Farben 10
12
53
16
135
37
11



Farbe 12 Beta Titan, Federscharnier

Skylight **3102**



SKYLIGHT
TITANIUM EYEWEAR

BETA-TITANIUM
Nickel Allergy Free

- Größen 55-18
Farben 08
14
16
55
18
140
35
11

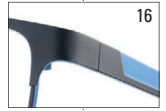

Farbe 08 Beta Titan, Federscharnier

Skylight **3101**



SKYLIGHT
TITANIUM EYEWEAR

BETA-TITANIUM
Nickel Allergy Free

- Größen 57-17
Farben 08
12
16
57
17
140
36
13

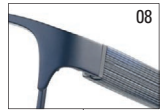

Farbe 16 Beta Titan, Federscharnier, Kunststoffbügel

Skylight **3100**



SKYLIGHT
TITANIUM EYEWEAR

BETA-TITANIUM
Nickel Allergy Free

- Größen 56-18
Farben 08
14
16
56
18
140
37
11

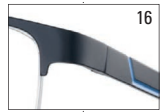

Farbe 14 Beta Titan, Federscharnier

readers **1199**

NEU



STAINLESS STEEL
premium selection

Farbe 14 Edelstahl, Federscharnier

Größen 53-19

- Farben 08
14
16
53
19
145
25
14



readers **1198**

NEU



STAINLESS STEEL
premium selection

Farbe 12 Edelstahl, Federscharnier, Kunststoffbügel

Größen 51-19

- Farben 10
12
16
51
19
145
24
14



readers **1197**

NEU



STAINLESS STEEL
premium selection

Farbe 05 Edelstahl, Federscharnier, Kunststoffbügel

Größen 50-19

- Farben 04
05
12
50
19
145
25
14



readers **1196**

NEU



STAINLESS STEEL
premium selection

Farbe 04 Edelstahl, Federscharnier

Größen 49-19

- Farben 04
05
15
16
49
19
145
23
14



readers **1195**

NEU



STAINLESS STEEL
premium selection

Farbe 16 Edelstahl, Federscharnier

- Größen 50-20
Farben 05
06
16
50
20
145
22
14

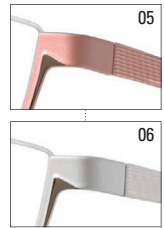

readers **1194**



STAINLESS STEEL
premium selection

Farbe 12 Edelstahl, Federscharnier

- Größen 56-18
Farben 08
12
14
56
18
150
27
14

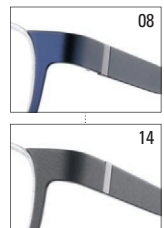

readers **1193**



STAINLESS STEEL
premium selection

Farbe 08 Edelstahl, Federscharnier, Kunststoffbügel

- Größen 56-18
Farben 08
12
14
56
18
150
26
16

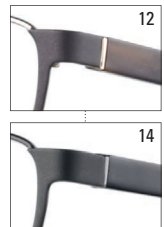

readers **1181**



XTRA LIGHT ACETATE
premium selection

Farbe 16 Zelluloseacetat, Federscharnier

- Größen 52-20
Farben 08
12
16
52
20
145
23
12

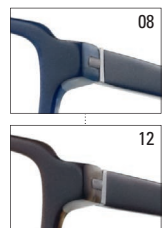

readers **1180**



STAINLESS STEEL
premium selection

Farbe 10 Edelstahl, Federscharnier, Kunststoffbügel

- Größen 49-20
Farben 10
12
15
49
20
145
23
15



readers **1177**



STAINLESS STEEL
premium selection

Farbe 16 Edelstahl, Federscharnier

- Größen 50-20
Farben 10
12
16
50
20
145
23
14



readers **1176**



STAINLESS STEEL
premium selection

Farbe 16 Edelstahl, Federscharnier, Kunststoffbügel

- Größen 49-20
Farben 10
12
16
49
20
145
23
14

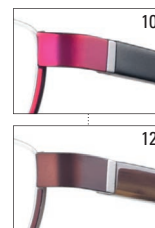

readers **1175**



STAINLESS STEEL
premium selection

Farbe 16 Edelstahl, Federscharnier

- Größen 50-19
Farben 10
12
16
50
19
145
24
15



readers **1174**



STAINLESS STEEL
premium selection

Farbe 12 Edelstahl, Federscharnier

- Größen 49-19
Farben 08
12
16
49
19
145
24
11

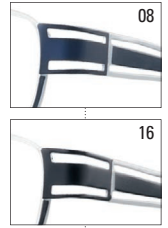

readers **1173**



STAINLESS STEEL
premium selection

Farbe 10 Edelstahl, Federscharnier, Kunststoffbügel

- Größen 48-21
Farben 10
12
15
48
21
145
23
14

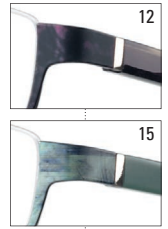

readers **1170**



STAINLESS STEEL
premium selection

Farbe 16 Edelstahl, Federscharnier, Kunststoffbügel

- Größen 51-22
Farben 12
14
16
51
22
145
23
17

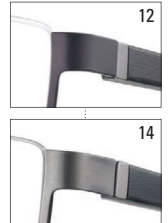

readers **1168**



BEFLEX
STAINLESS STEEL

Farbe 16 Edelstahl, Federscharnier, BEFLEX Memorybrücke

- Größen 52-22
Farben 12
16
52
22
145
26
14



readers **1163**



STAINLESS STEEL
premium selection

- Größen 51-22
 Farben 12
 14
 16
 51
 22
 145
 24
 15

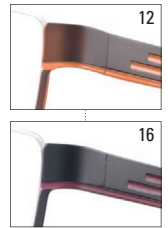

Farbe 14 Edelstahl, Federscharnier

readers **1155**



STAINLESS STEEL
premium selection

- Größen 52-22
 Farben 08
 12
 16
 52
 22
 145
 26
 19

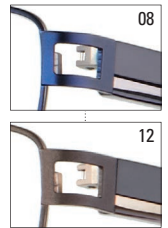

Farbe 16 Edelstahl, Federscharnier, Kunststoffbügel

readers **1143**



STAINLESS STEEL
premium selection

- Größen 51-20
 Farben 12
 14
 16
 51
 20
 145
 22
 20

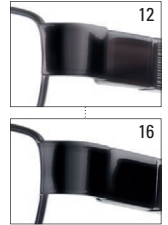

Farbe 14 Edelstahl, Federscharnier, Kunststoffbügel, Vollsteg



RIESIGE AUSWAHL – TOPPREIS – SUPER STYLE

STARTUP



6229-15

Hochwertige Brillen für alle, die modische, preiswerte und qualitativ gute Produkte schätzen. Für Jugendliche, Junggebliebene, Best Ager+. Leichte und komfortable Fassungen aus Edelstahl oder xtra-light-Acetat, in modernem Look. Und der Preis? Easy. Moderat! Das leistet man sich mit einem Lächeln.



8269-04



5495-12

STARTUP
premium+

TOP PREIS LEISTUNG

Start Up Premium **8281** **NEU**

STARTUP
premium



STAINLESS STEEL
premium selection

Farbe 02 Edelstahl

Größen 50-17
Farben 02

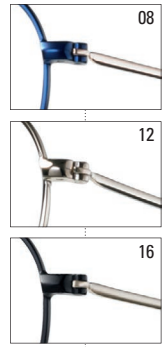

TOP PREIS LEISTUNG

Start Up Premium **8269** **NEU**

STARTUP
premium



STAINLESS STEEL
premium selection

Farbe 04 Edelstahl, Federscharnier, Kunststoffbügel

Größen 49-18
Farben 04

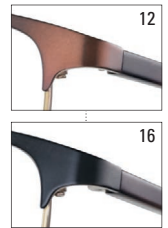

TOP PREIS LEISTUNG

Start Up Premium **8268** **NEU**

STARTUP
premium



STAINLESS STEEL
premium selection

Farbe 16 Edelstahl, Federscharnier, Kunststoffbügel

Größen 48-19
Farben 04

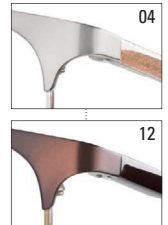

TOP PREIS LEISTUNG

Start Up Premium **8267** **NEU**

STARTUP
premium



STAINLESS STEEL
premium selection

Farbe 16 Edelstahl, Federscharnier

Größen 50-17
Farben 02

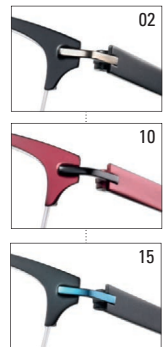

TOP PREIS LEISTUNG

Start Up Premium **8245**

STARTUP
premium



STAINLESS STEEL
premium selection

Farbe 15 Edelstahl, Federscharnier

Größen 53-17

Farben 12

15

16

17



53

17

135

38

15



12



16



17

TOP PREIS LEISTUNG

Start Up Premium **8244**

STARTUP
premium



STAINLESS STEEL
premium selection

Farbe 16 Edelstahl

Größen 54-17

Farben 12

16

17



54

17

135

38

13

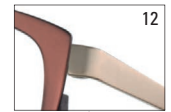

12



17

TOP PREIS LEISTUNG

Start Up Premium **8219**

STARTUP
premium



STAINLESS STEEL
premium selection

Farbe 12 Edelstahl, Federscharnier

Größen 55-16

Farben 10

12

16



55

16

135

38

18



10



16

TOP PREIS LEISTUNG

Start Up Premium **8217**

STARTUP
premium



STAINLESS STEEL
premium selection

Farbe 16 Edelstahl, Federscharnier

Größen 52-17

Farben 10

12

16



52

17

135

36

15



10



12

TOP PREIS LEISTUNG

Start Up Premium **8216**

STARTUP
premium



STAINLESS STEEL
premium selection

- Größen 49-16
Farben 08
12
16
49
16
130
33
15

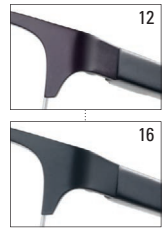

Farbe 08 Edelstahl, Federscharnier, Kunststoffbügel

TOP PREIS LEISTUNG

Start Up Premium **8215**

STARTUP
premium



STAINLESS STEEL
premium selection

- Größen 52-17
Farben 10
12
16
52
17
135
35
16

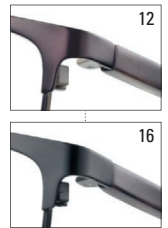

Farbe 10 Edelstahl, Federscharnier, Kunststoffbügel

TOP PREIS LEISTUNG

Start Up Premium **8201**

STARTUP
premium



STAINLESS STEEL
premium selection

- Größen 52-17
Farben 08
12
16
52
17
135
37
14

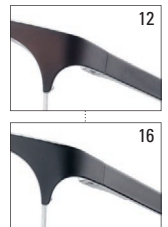

Farbe 08 Edelstahl, Federscharnier

TOP PREIS LEISTUNG

Start Up Premium **8199**

STARTUP
premium



STAINLESS STEEL
premium selection

- Größen 54-16
Farben 12
16
54
16
135
37
18



Farbe 16 Edelstahl, Federscharnier, Kunststoffbügel

TOP PREIS LEISTUNG

Start Up Premium **8183**

STARTUP
premium



Größen 53-16
Farben 08

- 10
- 16
- 53
- 16
- 135
- 35
- 14

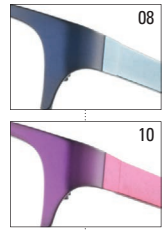

Farbe 16 Edelstahl, Federscharnier

STAINLESS STEEL
premium selection

TOP PREIS LEISTUNG

Start Up Premium **7988**

NEU

STARTUP
premium



Größen 55-18
Farben 08

- 12
- 16
- 55
- 18
- 140
- 34
- 15

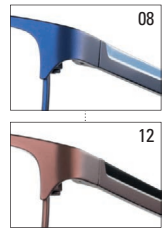

Farbe 16 Edelstahl, Federscharnier

STAINLESS STEEL
premium selection

TOP PREIS LEISTUNG

Start Up Premium **7987**

NEU

STARTUP
premium



Größen 52-14
Farben 08

- 14
- 16
- 52
- 14
- 140
- 44
- 11



Farbe 16 Edelstahl

STAINLESS STEEL
premium selection

TOP PREIS LEISTUNG

Start Up Premium **7965**

STARTUP
premium



Größen 55-18
Farben 08

- 14
- 16
- 55
- 18
- 140
- 35
- 21

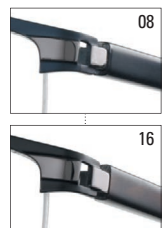

Farbe 14 Edelstahl, Federscharnier, Kunststoffbügel

STAINLESS STEEL
premium selection

TOP PREIS LEISTUNG

Start Up Premium **7948**

STARTUP
premium



Größen 54-18

Farben 08

- 14
- 16
- 54
- 18
- 140
- 33
- 15

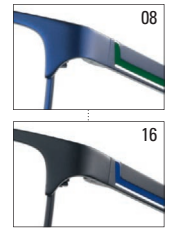

Farbe 14 Edelstahl, Federscharnier

STAINLESS STEEL
premium selection

TOP PREIS LEISTUNG

Start Up Premium **7947**

STARTUP
premium



Größen 56-17

Farben 08

- 14
- 16
- 56
- 17
- 140
- 35
- 16

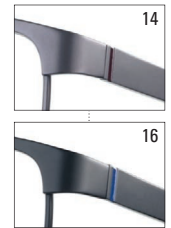

Farbe 08 Edelstahl, Federscharnier

STAINLESS STEEL
premium selection

TOP PREIS LEISTUNG

Start Up Premium **7946**

STARTUP
premium



Größen 59-17

Farben 08

- 12
- 16
- 59
- 17
- 140
- 36
- 22

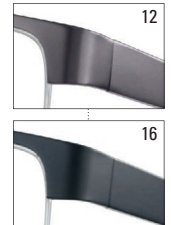

Farbe 08 Edelstahl, Federscharnier

STAINLESS STEEL
premium selection

TOP PREIS LEISTUNG

Start Up Premium **7945**

STARTUP
premium



Größen 58-18

Farben 08

- 12
- 16
- 58
- 18
- 140
- 36
- 21

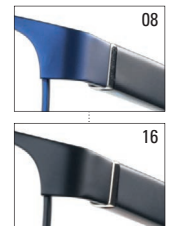

Farbe 12 Edelstahl, Federscharnier, Kunststoffbügel

STAINLESS STEEL
premium selection

TOP PREIS LEISTUNG

Start Up Premium **7937**

STARTUP
premium



STAINLESS STEEL
premium selection

Farbe 14 Edelstahl, Federscharnier, Kunststoffbügel

- Größen 53-17
Farben 08
14
16
53
17
140
33
18

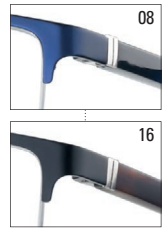

TOP PREIS LEISTUNG

Start Up Premium **7936**

STARTUP
premium



STAINLESS STEEL
premium selection

Farbe 16 Edelstahl, Federscharnier, Kunststoffbügel

- Größen 55-16
Farben 08
14
16
55
16
140
34
18

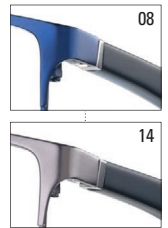

TOP PREIS LEISTUNG

Start Up Premium **7935**

STARTUP
premium



STAINLESS STEEL
premium selection

Farbe 08 Edelstahl, Federscharnier, Kunststoffbügel

- Größen 55-17
Farben 08
14
16
55
17
140
34
18

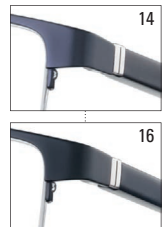

TOP PREIS LEISTUNG

Start Up Premium **7934**

STARTUP
premium



STAINLESS STEEL
premium selection

Farbe 16 Edelstahl, Federscharnier, Bohrbrille

- Größen 54-16
Farben 08
14
16
54
16
140
31
12

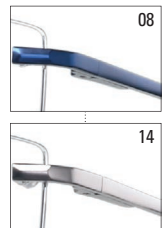

TOP PREIS LEISTUNG

Start Up Premium 7929

STARTUP
premium



STAINLESS STEEL
premium selection

- Größen 50-17
Farben 08
14
16
50
17
135
29
15

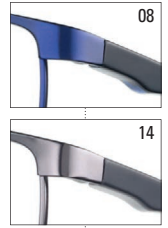

Farbe 16 Edelstahl, Federscharnier, Kunststoffbügel

TOP PREIS LEISTUNG

Start Up Premium 7928

STARTUP
premium



STAINLESS STEEL
premium selection

- Größen 54-17
Farben 08
14
16
54
17
140
32
15

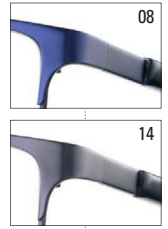

Farbe 16 Edelstahl, Federscharnier, Kunststoffbügel

TOP PREIS LEISTUNG

Start Up Premium 7903

STARTUP
premium



STAINLESS STEEL
premium selection

- Größen 58-18
Farben 08
12
16
58
18
140
37
21

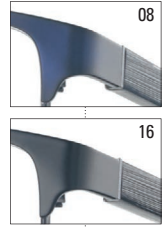

Farbe 12 Edelstahl, Federscharnier, Kunststoffbügel

TOP PREIS LEISTUNG

Start Up Premium 7892

STARTUP
premium



STAINLESS STEEL
premium selection

- Größen 57-19
Farben 12
16
57
19
140
36
20



Farbe 16 Edelstahl, Federscharnier, Kunststoffbügel

TOP PREIS LEISTUNG

Start Up Premium **7891**

STARTUP
premium



STAINLESS STEEL
premium selection

Farbe 08 Edelstahl, Federscharnier, Kunststoffbügel

- Größen 55-17
Farben 08
14
16
55
17
140
34
18

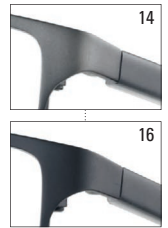

TOP PREIS LEISTUNG

Start Up Premium **7846**

STARTUP
premium



STAINLESS STEEL
premium selection

Farbe 14 Edelstahl, Federscharnier, Kunststoffbügel

- Größen 54-18
Farben 12
14
16
54
18
140
34
20

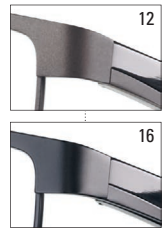

TOP PREIS LEISTUNG

Start Up Premium **7825**

STARTUP
premium



STAINLESS STEEL
premium selection

Farbe 16 Edelstahl, Federscharnier, Kunststoffbügel

- Größen 58-18
Farben 08
14
16
58
18
140
35
22

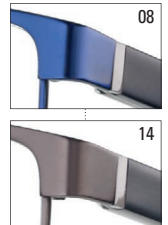

TOP PREIS LEISTUNG

Start Up Premium **6229**

NEU

STARTUP
premium



XTRA LIGHT ACETATE
premium selection

Farbe 15 Zelluloseacetat, Federscharnier

- Größen 51-16
Farben 08
14
15
16
51
16
140
37
13

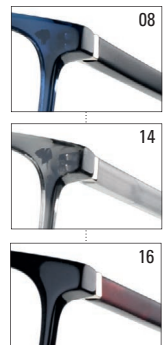

TOP PREIS LEISTUNG

Start Up Premium **6223**

NEU

STARTUP
premium



XTRA LIGHT ACETATE
premium selection

Farbe 08 Zelluloseacetat, Federscharnier

- Größen 56-17
Farben 08
12
16
56
17
145
40
13

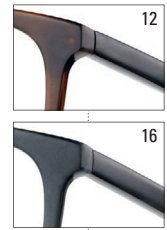

TOP PREIS LEISTUNG

Start Up Premium **6222**

NEU

STARTUP
premium



XTRA LIGHT ACETATE
premium selection

Farbe 16 Zelluloseacetat, Federscharnier, Metallbügel

- Größen 54-18
Farben 08
12
16
54
18
140
41
13

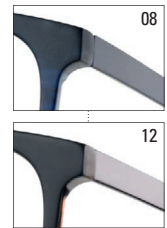

TOP PREIS LEISTUNG

Start Up Premium **6218**

STARTUP
premium



XTRA LIGHT ACETATE
premium selection

Farbe 12 Zelluloseacetat, Federscharnier

- Größen 54-17
Farben 08
12
16
54
17
140
31
13

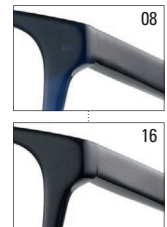

TOP PREIS LEISTUNG

Start Up Premium **6212**

STARTUP
premium



XTRA LIGHT ACETATE
premium selection

Farbe 15 Zelluloseacetat, Federscharnier

- Größen 49-16
Farben 08
15
16
49
16
135
28
12

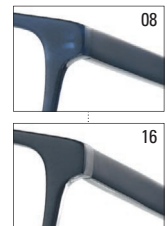

TOP PREIS LEISTUNG

Start Up Premium **6208**

STARTUP
premium



XTRA LIGHT ACETATE
premium selection

Farbe 16 Zelluloseacetat, Federscharnier

- Größen 53-17
Farben 08
12
16
53
17
145
37
13

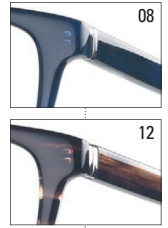

TOP PREIS LEISTUNG

Start Up Premium **6207**

STARTUP
premium



XTRA LIGHT ACETATE
premium selection

Farbe 12 Zelluloseacetat, Federscharnier

- Größen 50-20
Farben 08
12
16
50
20
145
38
12

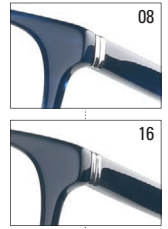

TOP PREIS LEISTUNG

Start Up Premium **6206**

STARTUP
premium



XTRA LIGHT ACETATE
premium selection

Farbe 08 Zelluloseacetat, Federscharnier

- Größen 52-17
Farben 08
12
16
52
17
140
31
16

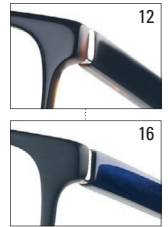

TOP PREIS LEISTUNG

Start Up Premium **6205**

STARTUP
premium



XTRA LIGHT ACETATE
premium selection

Farbe 16 Zelluloseacetat, Federscharnier

- Größen 54-18
Farben 08
12
16
54
18
140
38
12

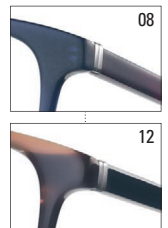

TOP PREIS LEISTUNG

Start Up Premium **6204**

STARTUP
premium



XTRA LIGHT ACETATE
premium selection

Farbe 12 Zelluloseacetat

Größen 53-17
Farben 08

- 10
- 12
- 16
- 53
- 17
- 140
- 35
- 11

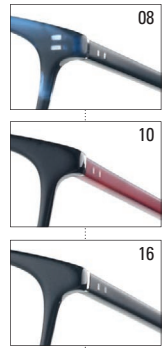

TOP PREIS LEISTUNG

Start Up Premium **6203**

STARTUP
premium



XTRA LIGHT ACETATE
premium selection

Farbe 08 Zelluloseacetat, Federscharnier

Größen 54-17
Farben 08

- 10
- 12
- 16
- 54
- 17
- 140
- 31
- 13

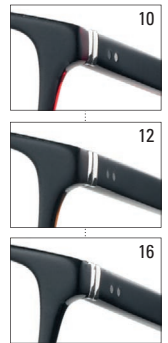

TOP PREIS LEISTUNG

Start Up Premium **6198**

STARTUP
premium



XTRA LIGHT ACETATE
premium selection

Farbe 12 Zelluloseacetat

Größen 55-16
Farben 08

- 12
- 55
- 16
- 140
- 39
- 11



TOP PREIS LEISTUNG

Start Up Premium **6197**

STARTUP
premium



HAND MADE ACETATE
premium selection

Farbe 08 Zelluloseacetat, Federscharnier

Größen 54-16
Farben 08

- 15
- 16
- 54
- 16
- 140
- 31
- 17

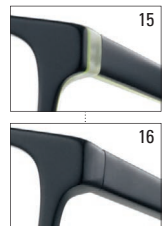

TOP PREIS LEISTUNG

Start Up Premium **6196**

STARTUP
premium



XTRA LIGHT ACETATE
premium selection

Farbe 12 Zelluloseacetat, Federscharnier

- Größen 55-16
Farben 08
12
16
55
16
140
33
14

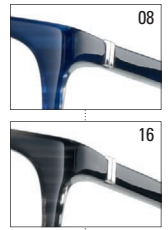

TOP PREIS LEISTUNG

Start Up Premium **6180**

STARTUP
premium



HAND MADE ACETATE
premium selection

Farbe 07 Zelluloseacetat, Federscharnier

- Größen 50-16
Farben 07
08
16
50
16
135
32
16

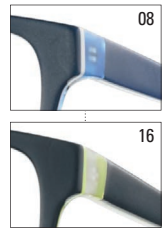

TOP PREIS LEISTUNG

Start Up Premium **6179**

STARTUP
premium



HAND MADE ACETATE
premium selection

Farbe 16 Zelluloseacetat, Federscharnier

- Größen 54-16
Farben 10
16
54
16
140
32
18



TOP PREIS LEISTUNG

Start Up Premium **5493**

NEU

STARTUP
premium



XTRA LIGHT ACETATE
premium selection

Farbe 16 Zelluloseacetat, Federscharnier

- Größen 49-15
Farben 08
14
15
16
49
15
135
37
12

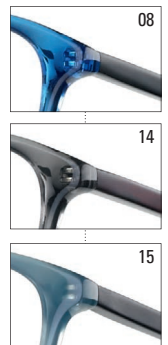

TOP PREIS LEISTUNG

Start Up Premium **5486**

NEU

STARTUP
premium



XTRA LIGHT ACETATE
premium selection

Farbe 12 Zelluloseacetat, Federscharnier

Größen 51-15
Farben 05

- 10
- 12
- 15
- 51
- 15
- 135
- 34
- 12

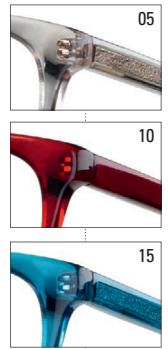

TOP PREIS LEISTUNG

Start Up Premium **5485**

NEU

STARTUP
premium



XTRA LIGHT ACETATE
premium selection

Farbe 12 Zelluloseacetat

Größen 49-17
Farben 05

- 11
- 12
- 16
- 49
- 17
- 140
- 39
- 12

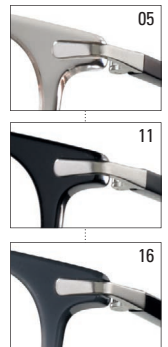

TOP PREIS LEISTUNG

Start Up Premium **5460**

STARTUP
premium



HAND MADE ACETATE
premium selection

Farbe 08 Zelluloseacetat, Metallbügel

Größen 53-18
Farben 08

- 12
- 16
- 53
- 18
- 140
- 39
- 14

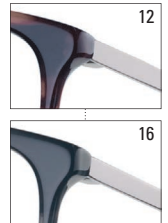

TOP PREIS LEISTUNG

Start Up Premium **5459**

STARTUP
premium



XTRA LIGHT ACETATE
premium selection

Farbe 11 Zelluloseacetat, Metallbügel

Größen 49-19
Farben 10

- 11
- 12
- 16
- 49
- 19
- 140
- 40
- 13

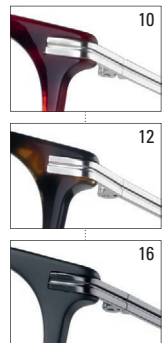

TOP PREIS LEISTUNG

Start Up Premium **5457**

STARTUP
premium



XTRA LIGHT ACETATE
premium selection

Farbe 10 Zelluloseacetat, Federscharnier

Größen 49-20
Farben 08

- 10
- 12
- 16
- 49
- 20
- 145
- 40
- 13

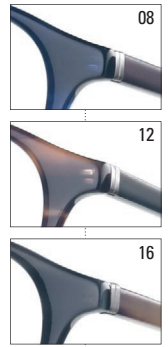

TOP PREIS LEISTUNG

Start Up Premium **5456**

STARTUP
premium



XTRA LIGHT ACETATE
premium selection

Farbe 12 Zelluloseacetat, Federscharnier

Größen 49-20
Farben 08

- 10
- 12
- 16
- 49
- 20
- 145
- 38
- 13

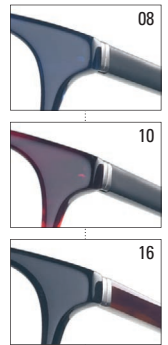

TOP PREIS LEISTUNG

Start Up Premium **5455**

STARTUP
premium



XTRA LIGHT ACETATE
premium selection

Farbe 08 Zelluloseacetat, Federscharnier

Größen 48-20
Farben 08

- 10
- 16
- 48
- 20
- 145
- 39
- 16

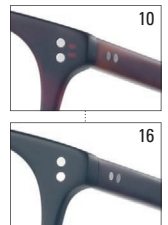

TOP PREIS LEISTUNG

Start Up Premium **5453**

STARTUP
premium



XTRA LIGHT ACETATE
premium selection

Farbe 15 Zelluloseacetat, Federscharnier

Größen 51-15
Farben 08

- 12
- 15
- 16
- 51
- 15
- 135
- 38
- 15



TOP PREIS LEISTUNG

Start Up Premium **5445**

STARTUP
premium



XTRA LIGHT ACETATE
premium selection

Farbe 16 Zelluloseacetat, Federscharnier

Größen 51-17

- Farben 08
10
12
16
51
17
140
35
15

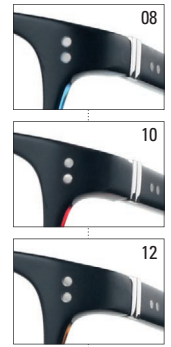

TOP PREIS LEISTUNG

Start Up Premium **5442**

STARTUP
premium



XTRA LIGHT ACETATE
premium selection

Farbe 12 Zelluloseacetat

Größen 53-16

- Farben 10
12
14
16
53
16
140
41
12



TOP PREIS LEISTUNG

Start Up Premium **5430**

STARTUP
premium



XTRA LIGHT ACETATE
premium selection

Farbe 16 Zelluloseacetat, Federscharnier

Größen 53-17

- Farben 08
10
12
16
53
17
140
39
14

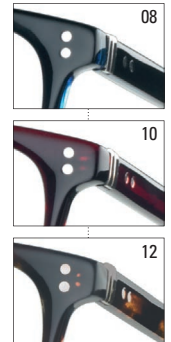

TOP PREIS LEISTUNG

Start Up Premium **5429**

STARTUP
premium



XTRA LIGHT ACETATE
premium selection

Farbe 10 Zelluloseacetat, Federscharnier

Größen 53-15

- Farben 10
12
16
53
15
140
35
14

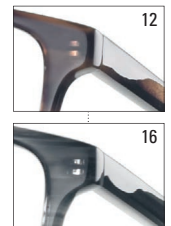

TOP PREIS LEISTUNG

Start Up Premium **5428**



STARTUP
premium

XTRA LIGHT ACETATE
premium selection

Farbe 12 Zelluloseacetat, Federscharnier

- Größen 50-18
Farben 10
12
16
50
18
140
39
14

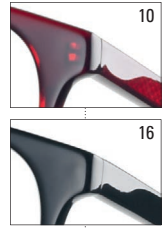

TOP PREIS LEISTUNG

Start Up Classic **8243**



STARTUP
classic

STAINLESS STEEL
premium selection

Farbe 12 Edelstahl

- Größen 54-17
56-17
Farben 08
10
12
54/56
17
135
36/38
17

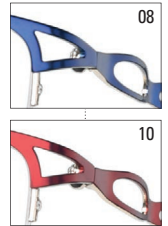

TOP PREIS LEISTUNG

Start Up Classic **8242**



STARTUP
classic

STAINLESS STEEL
premium selection

Farbe 08 Edelstahl, Federscharnier, Kunststoffbügel

- Größen 53-17
55-17
Farben 08
10
12
53/55
17
135
37/38
18

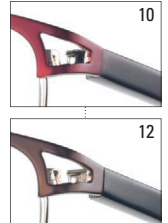

TOP PREIS LEISTUNG

Start Up Classic **8211**



STARTUP
classic

STAINLESS STEEL
premium selection

Farbe 14 Edelstahl, Federscharnier

- Größen 49-17
51-17
Farben 12
14
49/51
17
135
33/34
16



TOP PREIS LEISTUNG

Start Up Classic **8210**

STARTUP
classic



STAINLESS STEEL
premium selection

Farbe 10 Edelstahl, Federscharnier

- Größen 53-16
55-16
Farben 10
12
53/55
16
135
35/36
19



TOP PREIS LEISTUNG

Start Up Classic **8209**

STARTUP
classic



STAINLESS STEEL
premium selection

Farbe 12 Edelstahl, Federscharnier

- Größen 52-16
54-16
Farben 12
14
52/54
16
135
34/35
16



TOP PREIS LEISTUNG

Start Up Classic **8208**

STARTUP
classic



STAINLESS STEEL
premium selection

Farbe 10 Edelstahl, Federscharnier

- Größen 51-16
53-16
Farben 10
12
51/53
16
135
34/35
15



TOP PREIS LEISTUNG

Start Up Classic **8207**

STARTUP
classic



STAINLESS STEEL
premium selection

Farbe 12 Edelstahl, Federscharnier, Kunststoffbügel

- Größen 52-16
54-16
Farben 10
12
52/54
16
135
33/34
16



TOP PREIS LEISTUNG

Start Up Classic **8126**

STARTUP
classic



STAINLESS STEEL
premium selection

Farbe 12 Edelstahl, Federscharnier, Kunststoffbügel

- Größen 52-18
54-18
Farben 10
12
52/54
18
135
34/35
16



TOP PREIS LEISTUNG

Start Up Classic **7991**

NEU

STARTUP
classic



STAINLESS STEEL
premium selection

Farbe 12 Edelstahl, Federscharnier

- Größen 54-19
56-19
Farben 12
16
54/56
19
140
37/39
18



TOP PREIS LEISTUNG

Start Up Classic **7990**

NEU

STARTUP
classic



STAINLESS STEEL
premium selection

Farbe 14 Edelstahl, Federscharnier

- Größen 53-19
55-19
Farben 12
14
53/55
19
140
37/39
17



TOP PREIS LEISTUNG

Start Up Classic **7866**

STARTUP
classic



STAINLESS STEEL
premium selection

Farbe 12 Edelstahl, Federscharnier

- Größen 52-18
54-18
Farben 12
14
52/54
18
140
33/35
16



TOP PREIS LEISTUNG

Start Up Classic **7865**

STARTUP
classic



STAINLESS STEEL
premium selection

Farbe 14 Edelstahl, Federscharnier

- Größen 52-18
54-18
- Farben 12
14
- ⊖ 52/54
 - ⊗ 18
 - ⌒ 140
 - ⓪ 33/35
 - Ⓜ 16



TOP PREIS LEISTUNG

Start Up Classic **6199**

STARTUP
classic



HAND MADE ACETATE
premium selection

Farbe 14 Zelluloseacetat, Federscharnier

- Größen 52-19
54-19
56-19
- Farben 12
14
- ⊖ 52/54/56
 - ⊗ 19
 - ⌒ 140
 - ⓪ 35/37/40
 - Ⓜ 16



TOP PREIS LEISTUNG

Start Up Classic **5452**

STARTUP
classic



HAND MADE ACETATE
premium selection

Farbe 12 Zelluloseacetat, Federscharnier, Metallbügel

- Größen 52-16
- Farben 10
12
14
- ⊖ 52
 - ⊗ 16
 - ⌒ 135
 - ⓪ 36
 - Ⓜ 15



TOP PREIS LEISTUNG

Start Up Classic **5451**

STARTUP
classic



HAND MADE ACETATE
premium selection

Farbe 17 Zelluloseacetat, Federscharnier, Metallbügel

- Größen 53-17
- Farben 10
12
17
- ⊖ 53
 - ⊗ 17
 - ⌒ 135
 - ⓪ 38
 - Ⓜ 16



TOP PREIS LEISTUNG

Start Up Classic **5450**

STARTUP
classic



HAND MADE ACETATE
premium selection

Farbe 10 Zelluloseacetat, Federscharnier

- Größen 52-17
Farben 10
12
14
52
17
135
36
15



TOP PREIS LEISTUNG

Start Up Classic **5449**

STARTUP
classic



HAND MADE ACETATE
premium selection

Farbe 10 Zelluloseacetat, Federscharnier

- Größen 50-16
52-16
Farben 10
12
50/52
16
135
38/39
18



TOP PREIS LEISTUNG

Start Up Classic **5443**

STARTUP
classic



HAND MADE ACETATE
premium selection

Farbe 10 Zelluloseacetat, Federscharnier, Metallbügel

- Größen 52-17
Farben 10
12
52
17
135
37
19



TOP PREIS LEISTUNG

Start Up Classic **5422**

STARTUP
classic



HAND MADE ACETATE
premium selection

Farbe 10 Zelluloseacetat, Federscharnier, Metallbügel

- Größen 52-15
54-15
Farben 10
12
52/54
15
130
36/37
17



TOP PREIS LEISTUNG

Start Up Classic **5405**

STARTUP
classic



HAND MADE ACETATE
premium selection

Farbe 12 Zelluloseacetat, Federscharnier

- Größen 50-16
52-16
Farben 10
12
50/52
16
130
32/34
18



10

TOP PREIS LEISTUNG

Start Up Classic **5404**

STARTUP
classic



HAND MADE ACETATE
premium selection

Farbe 10 Zelluloseacetat, Federscharnier

- Größen 53-16
Farben 10
12
53
16
135
34
17



12

TOP PREIS LEISTUNG

Start Up Fashion **2532**

STARTUP
fashion



HAND MADE ACETATE
premium selection

Farbe 12 Zelluloseacetat, Federscharnier

- Größen 50-17
Farben 10
12
50
17
135
35
20



10

TOP PREIS LEISTUNG

Start Up Fashion **2529**

STARTUP
fashion



STAINLESS STEEL
premium selection

Farbe 08* Edelstahl, Bohrbrille

Unterschiedliche
Glasformen*

- Größen 50-17
Farben 08
10
14
15
50
17
138
30/32
09

- Größen 53-17
Farbe 16
53
17
138
32
09



10*



14*



15*



16

Start Up Readers

TOP PREIS LEISTUNG

Start Up Readers 1192

STARTUP
readers



STAINLESS STEEL
premium selection

Farbe 16 Edelstahl, Federscharnier

Größen 48-20
Farben 04

- 08
- 10
- 16
- 48
- 20
- 145
- 25
- 17

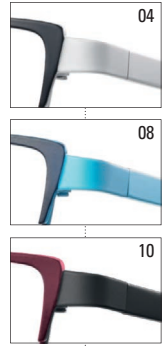

TOP PREIS LEISTUNG

Start Up Readers 1191

STARTUP
readers



STAINLESS STEEL
premium selection

Farbe 08 Edelstahl, Federscharnier

Größen 50-20
Farben 08

- 12
- 14
- 16
- 50
- 20
- 145
- 26
- 16

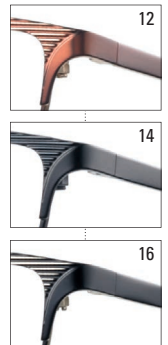

TOP PREIS LEISTUNG

Start Up Readers 1190

STARTUP
readers



STAINLESS STEEL
premium selection

Farbe 14 Edelstahl, Federscharnier

Größen 51-21
Farben 08

- 12
- 14
- 51
- 21
- 145
- 23
- 14

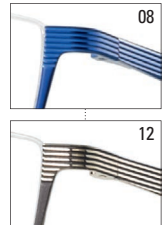

TOP PREIS LEISTUNG

Start Up Readers 1188

STARTUP
readers



HAND MADE ACETATE
premium selection

Farbe 12 Zelluloseacetat, Federscharnier

Größen 49-21
Farben 08

- 10
- 12
- 16
- 49
- 21
- 145
- 23
- 14

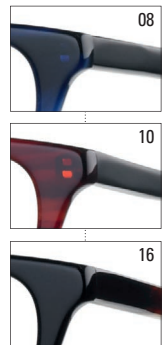

TOP PREIS LEISTUNG

Start Up Readers **1187**

STARTUP
readers



STAINLESS STEEL
premium selection

Farbe 16 Edelstahl, Federscharnier

Größen 48-19

- Farben 08
12
16
17
48
19
145
22
14

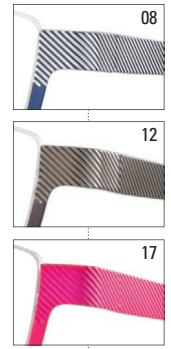

TOP PREIS LEISTUNG

Start Up Readers **1186**

STARTUP
readers



XTRA LIGHT ACETATE
premium selection

Farbe 16 Zelluloseacetat, Federscharnier

Größen 45-21

- Farben 08
10
16
45/47
21
145
24/25
13

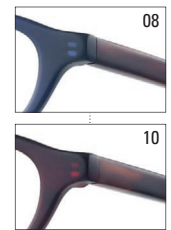

TOP PREIS LEISTUNG

Start Up Readers **1185**

STARTUP
readers



STAINLESS STEEL
premium selection

Farbe 14 Edelstahl, Federscharnier

Größen 48-21

- Farben 08
14
16
48
21
145
24
18

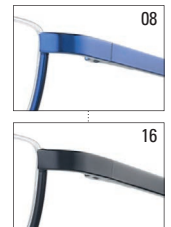

TOP PREIS LEISTUNG

Start Up Readers **1184**

STARTUP
readers



STAINLESS STEEL
premium selection

Farbe 17 Edelstahl, Federscharnier

Größen 50-19

- Farben 08
15
16
17
50
19
145
24
13

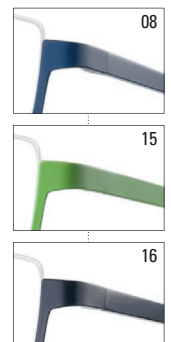

TOP PREIS LEISTUNG

Start Up Readers **1183**

STARTUP
readers



STAINLESS STEEL
premium selection

Farbe 08 Edelstahl, Federscharnier, Kunststoffbügel

- Größen 52-20
Farben 08
14
16
52
20
145
24
18

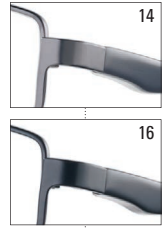

TOP PREIS LEISTUNG

Start Up Readers **1172**

STARTUP
readers



STAINLESS STEEL
premium selection

Farbe 14 Edelstahl, Federscharnier, Kunststoffbügel

- Größen 52-21
Farben 08
12
14
16
52
21
145
29
18

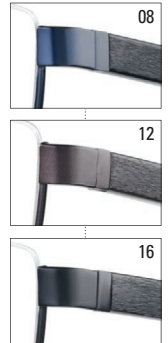

TOP PREIS LEISTUNG

Start Up Readers **1171**

STARTUP
readers



STAINLESS STEEL
premium selection

Farbe 12 Edelstahl, Federscharnier, Kunststoffbügel

- Größen 51-21
Farben 08
12
14
51
21
145
22
17

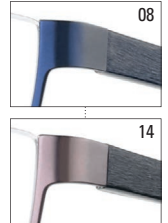

TOP PREIS LEISTUNG

Start Up Readers **1166**

STARTUP
readers



STAINLESS STEEL
premium selection

Farbe 14 Edelstahl, Federscharnier, Kugelschreiber-Clip

- Größen 52-21
Farben 02
14
16
52
21
145
26
17



Start Up Readers

TOP PREIS LEISTUNG

Start Up Readers 1150

STARTUP
readers



STAINLESS STEEL
premium selection

Farbe 14 Edelstahl, Federscharnier, Kunststoffbügel

- Größen 51-20
Farben 08
14
16
51
20
145
22
18

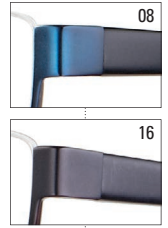

TOP PREIS LEISTUNG

Start Up Readers 1149

STARTUP
readers



STAINLESS STEEL
premium selection

Farbe 16 Edelstahl, Federscharnier, Kunststoffbügel

- Größen 52-21
Farben 08
14
16
52
21
145
26
18

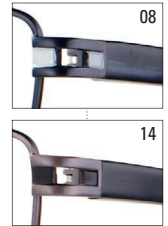

TOP PREIS LEISTUNG

Start Up Readers 1052

STARTUP
readers



Farbe 14 Federscharnier

- Größen 50-21
52-21
Farben 02
08
14
50/52
21
145
27/29
13

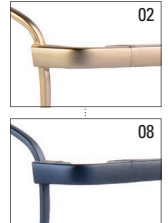

TOP PREIS LEISTUNG

Start Up Readers 1041

STARTUP
readers



Farbe 08 Federscharnier

- Größen 49-21
Farben 02
08
14
49
21
145
25
12

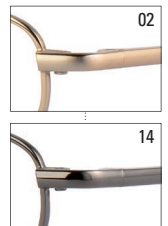

TOP PREIS LEISTUNG

Start Up Basics **8206**

STARTUP
basics



Farbe 12 Federscharnier

- | | | | |
|--------|-------|----------|----|
| Größen | 51-18 | | 02 |
| | 53-18 | | |
| | 55-18 | | |
| Farben | 02 | | 16 |
| | 12 | | |
| | 16 | | |
| | | 51/53/55 | |
| | | 18 | |
| | | 135 | |
| | | 36/37/39 | |
| | | 18 | |

TOP PREIS LEISTUNG

Start Up Basics **8205**

STARTUP
basics



Farbe 10 Federscharnier

- | | | | |
|--------|-------|----------|----|
| Größen | 48-18 | | 02 |
| | 50-18 | | |
| | 52-18 | | |
| Farben | 02 | | 12 |
| | 10 | | |
| | 12 | | |
| | | 48/50/52 | |
| | | 18 | |
| | | 135 | |
| | | 33/35/36 | |
| | | 18 | |

TOP PREIS LEISTUNG

Start Up Basics **7933**

STARTUP
basics



Farbe 16 Federscharnier

- | | | | |
|--------|-------|----------|----|
| Größen | 51-18 | | 02 |
| | 53-18 | | |
| | 55-18 | | |
| Farben | 02 | | 14 |
| | 14 | | |
| | 16 | | |
| | | 51/53/55 | |
| | | 18 | |
| | | 140 | |
| | | 32/33/34 | |
| | | 18 | |

TOP PREIS LEISTUNG

Start Up Basics **7932**

STARTUP
basics



Farbe 14 Federscharnier

- | | | | |
|--------|-------|----------|----|
| Größen | 52-18 | | 02 |
| | 54-18 | | |
| | 56-18 | | |
| Farben | 02 | | 12 |
| | 12 | | |
| | 14 | | |
| | 16 | | |
| | | 52/54/56 | |
| | | 18 | |
| | | 140 | |
| | | 36/38/39 | |
| | | 19 | |

TOP PREIS LEISTUNG

Start Up Basics **7931**

STARTUP
basics



Farbe 02 Federscharnier

| | | | |
|--------|----------|--|----|
| Größen | 50-18 | | 12 |
| | 52-18 | | |
| | 54-18 | | |
| Farben | 02 | | 14 |
| | 12 | | |
| | 14 | | |
| | 16 | | |
| | 50/52/54 | | |
| | 18 | | |
| | 140 | | |
| | 32/34/36 | | |
| | 18 | | |

TOP PREIS LEISTUNG

Start Up Basics **7743**

STARTUP
basics



Farbe 14

| | | | |
|--------|-------|--|----|
| Größen | 50-18 | | 01 |
| | 52-18 | | |
| Farben | 01 | | 02 |
| | 02 | | |
| | 14 | | |
| | 16 | | |
| | 50/52 | | |
| | 18 | | |
| | 140 | | |
| | 32/33 | | |
| | 13 | | 16 |

TOP PREIS LEISTUNG

Start Up Basics **7742**

STARTUP
basics



Farbe 16

| | | | |
|--------|-------|--|----|
| Größen | 52-18 | | 01 |
| | 54-18 | | |
| Farben | 01 | | 02 |
| | 02 | | |
| | 14 | | |
| | 16 | | |
| | 52/54 | | |
| | 18 | | |
| | 140 | | |
| | 34/35 | | |
| | 14 | | 14 |

TOP PREIS LEISTUNG

Start Up Basics **6200**

STARTUP
basics



Farbe 14

| | | | |
|--------|-------|--|----|
| Größen | 52-18 | | 12 |
| | 54-18 | | |
| Farben | 12 | | |
| | 14 | | |
| | 52/54 | | |
| | 18 | | |
| | 140 | | |
| | 34/35 | | |
| | 14 | | |

TOP PREIS LEISTUNG

Start Up Basics **5447**

STARTUP
basics



Farbe 10

- Größen 52-17
54-17
- Farben 10
12
17
- ⊖ 52/54
⊗ 17
⌒ 135
⊕ 36/38
Ⓜ 14

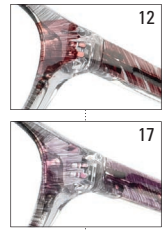

TOP PREIS LEISTUNG

Start Up Basics **5444**

STARTUP
basics



Farbe 10

- Größen 50-17
52-17
- Farben 10
12
14
- ⊖ 50/52
⊗ 17
⌒ 135
⊕ 35/37
Ⓜ 14

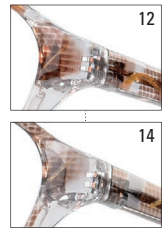

TOP PREIS LEISTUNG

Start Up Basics **1182**

STARTUP
basics



Farbe 16 Federscharnier

- Größen 48-19
50-19
52-19
- Farben 02
10
14
16
- ⊖ 48/50/52
⊗ 19
⌒ 145
⊕ 27/28/29
Ⓜ 12

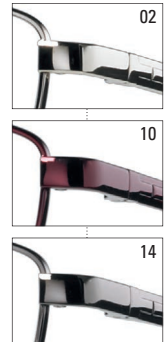

TOP PREIS LEISTUNG

Start Up Basics **1129**

STARTUP
basics



Farbe 14

- Größen 47-21
49-21
- Farben 02
12
14
16
- ⊖ 47/49
⊗ 21
⌒ 145
⊕ 26/27
Ⓜ 13

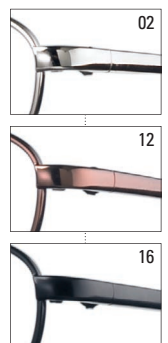

TOP
PREIS
LEISTUNG

Start Up Basics 1112

STARTUP
basics



Farbe 14 Federscharnier

Größen 48-23
50-23

Farben 01
02
14
16
48/50
23
145
26/27
13





8277-02

Beilagen

DIN A4
4 Seiten
4/4-farbig
135 g Papier

MUSTER OPTIK

LOOK & FEEL
EYEWEAR COLLECTION

GROSSE AUSWAHL - TOPPREIS - SUPER STYLE

OPTIK MUSTERMANN

129 €
249 €

Optik Mustermann

NUR BIS 00.00.2019

Optik Mustermann

NUR BIS 00.00.2019

KOMPLETTBRIKLEN IA-PREISE

98 €
249 €

BETTER SEHGENUSS UNSEREN IA-PREISEN

ALLES ZUSAMMEN, EIN PREIS. GARANTIERT GÜNSTIG!

98 €
249 €

Poster

DIN A1
4-farbig

LOOK & FEEL

LOOK & FEEL
EYEWEAR COLLECTION

Aufsteller

DIN A5
2 Seiten
4-farbig



Direct-Mailings

Maxikarte:
125 x 235 mm
2 Seiten

Selfmailer:
100 x 210 mm
6 Seiten + Klapper



Imageanzeigen

DIN A5
4-farbig

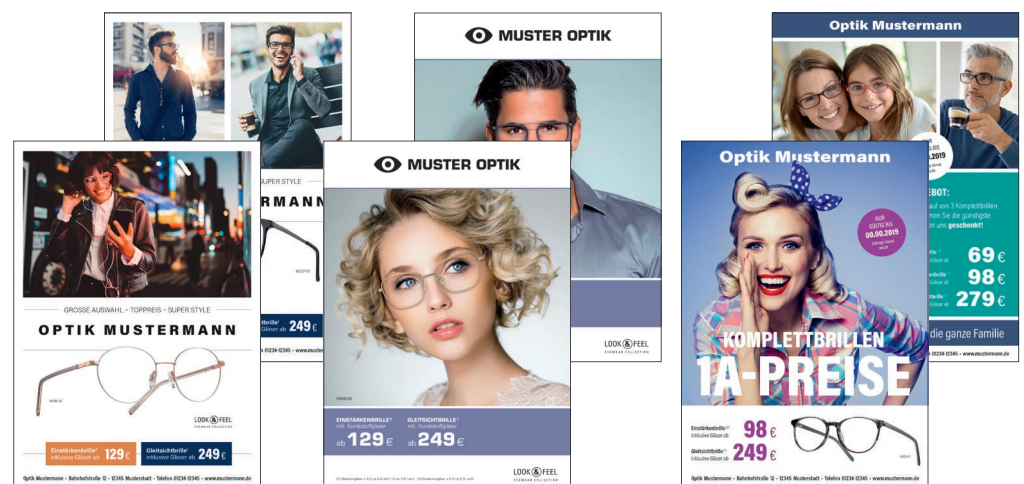

Sie haben keine Marketingmappe bekommen?

Fordern Sie Ihr Exemplar an unter: kontakt@binde-optik.de oder telefonisch 0571 / 28013 bei unserer Marketingexpertin Tanja Rautmann.

ZERTIFIKAT

zur Biokompatibilität

Allergie Schutzlackierung für Brillengestelle (VC-80075 Dreikomponenten-Klarlack)

Passive Oberflächenveredelung durch

Binde Optik GmbH & Co. KG
Postfach 2160 · D-32378 Minden

Prüfungen zur Biokompatibilität

Wir bestätigen, daß die folgenden Prüfungen zur Bestimmung der Biokompatibilität gemäß der internationalen Norm DIN EN ISO 10993-1: 1998 "Biologische Beurteilung von Medizinprodukten - Teil 1: Beurteilung und Prüfung" durchgeführt wurden:

1. Zytotoxizitätsprüfung

Die potentielle zelltoxische Wirkung der mit VC-80075 Dreikomponenten-Klarlack behandelten Neusilber Prüflinge wurde im Vergleich zu nicht-lackierten Prüflingen aus Neusilber in-vitro gemäß ISO 10993-5: 1992 im Wachstumshemmtest untersucht. Der unverdünnte Materialextrakt der lackierten Prüflinge löste eine Wachstumshemmung von 43 % aus, die in der nächsten Verdünnungsstufe nicht mehr nachweisbar war. Der unverdünnte Extrakt der nicht-lackierten Prüflinge verursachte eine vollständige Wachstumshemmung.

2. Sensibilisierungsprüfung

Die potentielle allergieauslösende Wirkung der mit VC-80075 Dreikomponenten-Klarlack behandelten Neusilber Prüflinge wurde in-vivo gemäß ISO 10993-10: 1995 im Maximierungstest nach Magnusson & Kligman untersucht. Die Prüfung ergab keine Hinweise auf sensibilisierende Eigenschaften.

mdt medical device testing GmbH
Schloßstraße 17 · 88416 Ochsenhausen



Dr. Dieter R. Dannhorn, 12.08.1999

Allergieschutzbeschichtung

- › Allergieschutzbeschichtung gegen Nickelaustritt für alle Metallfassungen. (Auch für Fremdfassungen)
- › Die Farbechtheit der Fassung(en) bleibt weitgehend erhalten.
- › Besteht ohne Probleme den Schweißtest der DIN EN ISO 12870.
- › Diese Beschichtung erfüllt die DIN EN ISO 10993. (Biologische Beurteilung von Medizinprodukten)
- › Die aufgetragene Beschichtung wird auf Dichtigkeit kontrolliert. Nickeltest nach CR 12471 (screening-test).
- › Beginnend mit dem Tag der Auslieferung hält die Allergieschutzbeschichtung mindestens 12 Monate.

Hinweis:

Bei Einsendung der Brillenfassung(en), entfernen Sie bitte vorher alle nichtmetallischen Teile (Pad's, Cellenden, Celloberteile, usw.). Steg-, Bügel- und Bohrbrillenschrauben nicht entfernen! Bitte säubern Sie vorher die Fassung(en) von Schmutz und Grünspan.

Bei Fremdfabrikaten gilt:

Für entstandene Schäden beim Demontieren der Brillenfassung(en) übernehmen wir keine Haftung. Bitte geben Sie bei jeder Fassung die Modelldaten an (Hersteller, Modell-Nr., Farb-Nr. und Größe). Brillenfassungen, die mit einem Nagel- oder Autolack nachbehandelt sind, können wir nicht beschichten.

Rechtlicher Hinweis (Deutschland)

Das Medizinproduktegesetz verpflichtet den Augenoptiker (Sonderanfertiger), die von uns gegebenen Hinweise bezüglich der Produktinformation und Pflegehinweis zu beachten und auch an den Endverbraucher (Patient) weiterzugeben. Besonders ist darauf zu achten, dass unsere Produkte (Brillenfassungen) nicht mit Lösungsmitteln wie Spiritus, Aceton, Salmiaklösungen oder ähnliche Stoffe gereinigt werden. Dies kann zu allergischen oder toxischen Reaktionen führen.

Grundsätzlich ist der Augenoptiker (Sonderanfertiger) auch für die Beratung und Auswahl der „richtigen Brille“ für den Endkunden (Patient), bezüglich dessen allergischen Vorgeschichte verantwortlich. Bei schwangeren oder stillenden Frauen ist eine besondere Aufmerksamkeit notwendig. Bei der Verwendung von fremden oder falschen Ersatzteilen (z. B. Nasenstege), übernimmt Firma Binde Optik keine Haftung.

Pflegehinweis für Brillengestelle & Patienteninformation:

Bitte achten Sie darauf, die Brillenfassungen nicht mit aggressiven chemischen Reinigungs- oder Desinfektionsmitteln in Kontakt zu bringen. Insbesondere sollten Aceton, Nitroverdünnung, Terpentinersatz, Waschbenzin, Essigessenz, Salmiaklösung und chlorhaltige Reinigungsmittel vermieden werden. Solche Substanzen können das Farbdesign der Brillenfassung, die biologischen Eigenschaften von Kunststofffassungen und die antiallergische Schutzbeschichtung von Metallfassungen angreifen.

Cleaning of Optical Frames & Informations:

Please take care not to treat optical frames with aggressive chemical cleaning or disinfecting agents such as acetone, cellulose thinner, turpentine-like diluting agents, benzene, acetic acid, ammonium chloride or other chlorous chemicals. Such substances may damage the colour design or may adversely affect the biocompatibility of the plastic frames or may remove the allergy seal of metal frames.

Verkaufs-, Lieferungs- und Zahlungsbedingungen der Walter Binde Optik GmbH & Co. KG

1. Allgemeine Bestimmungen

Die nachstehenden Bedingungen werden sämtlichen Lieferungen und Leistungen zugrunde gelegt. Anders lautende Allgemeine Geschäftsbedingungen des Kunden, Abweichungen oder mündliche Nebenabreden sind nur verbindlich, wenn Sie entweder zwingendem Recht entsprechen oder von uns ausdrücklich schriftlich bestätigt worden sind. Der Vertrag bleibt auch im Fall der Unwirksamkeit einzelner Bestimmungen in seinen übrigen Teilen verbindlich. Etwaige unwirksame Bestimmungen sind von den Vertragspartnern im Rahmen des Zumutbaren nach Treu und Glauben durch solche Regelungen zu ersetzen, die dem wirtschaftlichen Zweck des Vertrages am besten gerecht werden, ohne dass dadurch der Vertragsinhalt wesentlich geändert wird. Das gleiche gilt, falls es an einer ausdrücklichen Regelung für einen regelungsbedürftigen Sachverhalt fehlt. Stellt das Festhalten an dem Vertrag eine unzumutbare Härte für eine Vertragspartei dar, so ist dieser unwirksam.

2. Vertrag und Umfang der Leistung

Unsere Angebote sind freibleibend. Aufträge sind für uns erst verbindlich, wenn sie von uns schriftlich bestätigt worden sind. Fehlt eine schriftliche Bestätigung, wird diese durch die erteilte Rechnung oder Lieferschein ersetzt. Maßgeblich für den Umfang der geschuldeten Leistung ist allein unsere schriftliche Bestätigung. Katalogangaben, Abbildungen, Produktbeschreibungen, etc. sind lediglich als annähernd zu betrachten. Unwesentliche und/oder handelsübliche Abweichungen, wie z.B. auch solche im Rahmen der ständigen Produktverbesserung, die die Verwendbarkeit nicht beeinträchtigen und dem Kunden zumutbar sind, bleiben vorbehalten.

3. Preise und Zahlungsbedingungen

Die Preise verstehen sich in Euro ab Werk Minden ausschließlich Verpackung zzgl. der jeweils geltenden Umsatzsteuer. Zahlungen haben innerhalb von 30 Tagen ab Rechnungsdatum ohne Abzug zu erfolgen, bei Zahlung innerhalb 10 Tagen ab Rechnungsdatum abzüglich 2 % Skonto. Die Zahlungen sind frei Zahlstelle des Lieferers zu leisten. Bei Verträgen mit Unternehmern können wir bei schuldhafter Überschreitung der Zahlungsfrist Verzugszinsen in Höhe von 8 % über dem jeweils geltenden Basiszinssatz nach § 247 BGB verlangen. Kommt der Kunde mit einem nicht unerheblichen Teil der Zahlung in Verzug oder gehen Schecks oder Wechsel zu Protest oder entfallen die Voraussetzungen für eine Kreditgewährung, so werden unsere sämtlichen Forderungen gegen ihn zur sofortigen Zahlung fällig. Dies gilt auch für ursprünglich gestundete Rechnungen sowie später fällige Wechsel oder Schecks. Verschlechtert sich die Vermögenslage des Kunden nach Vertragsabschluss erheblich oder wird eine bereits bestehende Kreditunwürdigkeit erst nach Vertragsabschluss erkennbar, sind wir berechtigt, die noch nicht ausgeführten Lieferungen zu verweigern bzw. angemessene Vorauszahlungen oder Sicherheitsleistungen zu verlangen, wenn die Gegenleistung gefährdet ist. Der Kunde kann nur mit solchen Forderungen aufrechnen, die unbestritten oder rechtskräftig festgestellt sind. Ein Zurückbehaltungsrecht kommt für ihn nur insoweit in Betracht, als es auf Ansprüchen aus demselben Vertragsverhältnis beruht.

4. Lieferung

Lieferfristen beginnen mit Vertragsschluss und können verbindlich nur schriftlich vereinbart werden. Die Lieferfrist verlängert sich angemessen, wenn der Käufer erforderliche und/oder vereinbarte Mitwirkungshandlungen verzögert oder unterläßt oder die vereinbarten Zahlungsbedingungen nicht einhält. Entsprechendes gilt bei Maßnahmen bei Eintritt unvorhergesehener Hindernisse, die außerhalb unserer Sphäre liegen, z. B. Lieferverzögerung eines Vorlieferanten, Verkehrs- und Betriebsstörungen, Werkstoff- oder Energiemangel, etc. Auch vom Kunden veranlaßte Änderungen der zu liefernden Ware führen zu einer angemessenen Verlängerung der Lieferfrist. Zu Teillieferungen sind wir berechtigt, soweit diese dem Kunden zumutbar sind. Bei einer länger andauernden Nichtverfügbarkeit der Leistung behalten wir uns den Rücktritt vom Vertrag vor.

5. Versand und Gefahrübergang

Bei Versendung der Ware geht die Gefahr des zufälligen Untergangs und der zufälligen Verschlechterung der Sache auf den Kunden über, wenn die Ware an die den Transport ausführende Person übergeben wird oder wenn die Ware zwecks Versendung unser Lager verlassen hat. Soweit nichts anderes vereinbart ist, steht die Versandart, der Transportweg, etc. in unserem Ermessen. Kosten für abweichende Kundenwünsche gehen zu dessen Lasten. Eine zusätzliche Versicherung gegen Transportschäden erfolgt nur auf Anordnung und Kosten des Kunden. Bitte beachten: Unfreie Pakete und Päckchen werden von der Firma Binde Optik GmbH & Co. KG nicht angenommen.

6. Sachmängelhaftung

Für die Verjährung von Ansprüchen wegen Sachmängel gelten die gesetzlichen Vorschriften. Liegen Mängel vor, kann der Kunde primär Nacherfüllung gemäß § 439 BGB verlangen. Wir sind berechtigt, zwischen der Beseitigung des Mangels und der Lieferung einer mangelfreien Sache zu wählen. Bitte beachten: Gewährleistungsansprüche sind zunächst auf zweimaliger Nacherfüllung beschränkt, wobei die Firma Binde Optik GmbH & Co. KG Kenntnis von der Nacherfüllung haben muss. Bei Fehlschlägen der Nacherfüllung besteht ein Anspruch auf Rücktritt vom Kaufvertrag. Mängelansprüche bestehen nicht bei einer unerheblichen Abweichung von der vereinbarten Beschaffenheit, bei einer unerheblichen Beeinträchtigung der Brauchbarkeit, bei natürlicher Abnutzung oder Schäden, die nach dem Gefahrübergang infolge fehlerhafter oder nachlässiger Behandlung, übermäßiger Beanspruchung, unsachgemäßem Gebrauch, mangelnder Pflege, etc. entstehen. Werden vom Kunden oder von Dritten unsachgemäß Änderungen oder Bearbeitungen vorgenommen, so bestehen für diese und die daraus entstehenden Folgen ebenfalls keine Mängelansprüche. Wir haften nach den gesetzlichen Bestimmungen auf Schadensersatz, sofern der Kunde Ansprüche geltend macht, die auf Arglist, Vorsatz oder grober Fahrlässigkeit unsererseits, auf Verletzung des Lebens, des Körpers oder der Gesundheit oder auf der Verletzung vertragswesentlicher Pflichten beruhen. Wird uns keine vorsätzliche oder grob fahrlässige Vertragsverletzung angelastet, haften wir nur auf den Ersatz des typischen vorhersehbaren Schadens. Eine Haftung für Schäden, die nicht am Liefergegenstand entstanden sind, scheidet aus, es sei denn, es handelt sich um Verletzungen des Lebens, des Körpers oder der Gesundheit, die aus einer von uns begangenen fahrlässigen Pflichtverletzung oder einer vorsätzlichen oder fahrlässigen Pflichtverletzung unseres gesetzlichen Vertreters oder Erfüllungsgehilfen beruhen. Im Übrigen ist die Schadensersatzhaftung ausgeschlossen.

7. Eigentumsvorbehalt

Wir behalten uns das Eigentum an sämtlichen gelieferten Waren bis zur vollständigen Bezahlung vor. Im Rechtsverkehr mit Kaufleuten gilt der Eigentumsvorbehalt auch, bis sämtliche, auch künftige und bedingte Forderungen aus der Geschäftsverbindung erfüllt sind. Zur Weiterveräußerung ist der Kunde nur im ordnungsgemäßen Geschäftsgang berechtigt, wobei er seine Forderung aus der Weiterveräußerung bereits jetzt an uns abtritt. Wir nehmen die Abtretung an. Zur Einziehung dieser Forderung bleibt der Kunde auch nach der Abtretung ermächtigt. Unsere Befugnis, die Forderung selbst einzuziehen, bleibt hiervon unberührt. Wir verpflichten uns, die Forderung nicht selbst einzuziehen, solange der Kunde seinen Zahlungsverpflichtungen vertragsgemäß nachkommt. Der Kunde ist nicht berechtigt, unter Eigentumsvorbehalt stehende Ware zu verpfänden oder zur Sicherheit zu übereignen. Einwirkungen Dritter auf diese Waren, insbesondere Pfändungen, sind uns unverzüglich mitzuteilen. Die Befugnis zur Weiterveräußerung kann von uns widerrufen werden, falls der Kunde seinen Verpflichtungen aus dem Vertrag nicht ordnungsgemäß nachkommt. Auf Verlangen des Kunden sind wir verpflichtet, eingeräumte Sicherheiten nach unserer Wahl freizugeben, soweit deren Wert unsere Forderungen um mehr als 10 % übersteigt.

8. Rückgriff des Unternehmers

Verkauft der Kunde die neu hergestellte Ware im Rahmen seines gewerblichen Betriebes an einen Verbraucher weiter und musste er diese Ware als Folge ihrer Mangelhaftigkeit zurücknehmen oder minderte der Verbraucher den Kaufpreis, so bedarf es für die Geltendmachung der Mängelansprüche des Kunden uns gegenüber keiner Fristsetzung. Der Kunde kann in dem Fall von uns Ersatz der Aufwendungen verlangen, die er im Verhältnis zum Verbraucher zu tragen hatte, wenn der vom Verbraucher geltend gemachte Mangel bereits bei Übergang der Gefahr auf den Kunden vorhanden war. Im Rahmen dieses Unternehmerückgriffs hat der Kunde keinen Anspruch auf Schadensersatz.

9. Sonstige Bestimmungen

Rücksendungen aus Auswahlendungen werden nur innerhalb von 14 Tagen akzeptiert. Die Ware muss original verpackt und in einem einwandfreien Zustand sein. Produktänderungen (Preise, Modelle, Farben) sind jederzeit über die Homepage (www.Binde-Optik.de) abrufbar. Produktinformationen bezüglich Material und Verträglichkeit werden grundsätzlich nur schriftlich beantwortet. Bitte beachten: Unfreie Pakete und Päckchen werden von der Firma Binde Optik GmbH & Co. KG nicht angenommen.

10. Abschließende Bestimmungen

Ist der Kunde Kaufmann, juristische Person des öffentlichen Rechts oder ein öffentlichrechtliches Sondervermögen, ist Gerichtsstand für alle sich aus dem Vertragsverhältnis ergebenden Streitigkeiten der für unseren Firmensitz zuständige Gerichtsort. Erfüllungsort ist Minden/Westfalen. Auf alle Verträge findet deutsches Recht Anwendung. „Verbraucher“ im Sinne dieser Bestimmungen ist gemäß § 13 BGB jede natürliche Person, die das Geschäft zu einem Zweck abschließt, der weder ihrer gewerblichen noch ihrer selbstständigen beruflichen Tätigkeit zugerechnet werden kann.

Sitz der KG: Minden, HRA 3533 Bad Oeynhausen

Pers. haftende Gesellschafterin: Binde-Beteiligungs-GmbH Minden, HRB 5095 Bad Oeynhausen,

Geschäftsführer: Jörn Binde, Walter Koenemann

| Art.-Nr. | Seite | Art.-Nr. | Seite | Art.-Nr. | Seite | Art.-Nr. | Seite | Art.-Nr. | Seite | Art.-Nr. | Seite |
|----------|-------|----------|-------|----------|-------|----------|-------|----------|-------|----------|-------|
| 1041 | 96 | 3103 | 65 | 5461 | 20 | 6227 | 38 | 7956 | 30 | 8209 | 88 |
| 1052 | 96 | 3104 | 64 | 5463 | 20 | 6228 | 38 | 7957 | 30 | 8210 | 88 |
| 1112 | 100 | 3105 | 64 | 5464 | 20 | 6229 | 79 | 7958 | 29 | 8211 | 87 |
| 1129 | 99 | 3106 | 64 | 5465 | 20 | 6230 | 37 | 7959 | 29 | 8212 | 11 |
| 1143 | 70 | 3107 | 64 | 5466 | 19 | 6231 | 37 | 7960 | 29 | 8213 | 11 |
| 1149 | 96 | 3108 | 63 | 5467 | 19 | 7742 | 98 | 7961 | 29 | 8215 | 74 |
| 1150 | 96 | 3109 | 63 | 5468 | 19 | 7743 | 98 | 7962 | 28 | 8216 | 74 |
| 1155 | 70 | 3110 | 63 | 5469 | 19 | 7753 | 48 | 7963 | 28 | 8217 | 73 |
| 1163 | 70 | 3111 | 63 | 5470 | 18 | 7788 | 48 | 7964 | 28 | 8219 | 73 |
| 1166 | 95 | 3112 | 62 | 5474 | 18 | 7798 | 37 | 7965 | 75 | 8220 | 44 |
| 1168 | 69 | 3113 | 62 | 5475 | 18 | 7800 | 37 | 7966 | 47 | 8221 | 44 |
| 1170 | 69 | 3114 | 62 | 5482 | 18 | 7808 | 36 | 7967 | 47 | 8222 | 44 |
| 1171 | 95 | 3115 | 62 | 5483 | 17 | 7825 | 79 | 7968 | 28 | 8225 | 11 |
| 1172 | 95 | 3116 | 61 | 5484 | 17 | 7846 | 79 | 7969 | 27 | 8226 | 10 |
| 1173 | 69 | 3117 | 61 | 5485 | 84 | 7852 | 36 | 7970 | 27 | 8227 | 10 |
| 1174 | 69 | 3118 | 61 | 5486 | 84 | 7862 | 48 | 7971 | 27 | 8228 | 10 |
| 1175 | 68 | 3119 | 61 | 5487 | 17 | 7865 | 90 | 7972 | 27 | 8229 | 10 |
| 1176 | 68 | 4268 | 59 | 5488 | 17 | 7866 | 89 | 7973 | 26 | 8230 | 44 |
| 1177 | 68 | 4270 | 59 | 5489 | 16 | 7881 | 36 | 7974 | 26 | 8231 | 9 |
| 1180 | 68 | 4271 | 59 | 5490 | 16 | 7882 | 36 | 7976 | 26 | 8232 | 9 |
| 1181 | 67 | 4277 | 59 | 5491 | 16 | 7891 | 79 | 7977 | 26 | 8234 | 9 |
| 1182 | 99 | 4279 | 58 | 5492 | 16 | 7892 | 78 | 7978 | 25 | 8235 | 9 |
| 1183 | 95 | 4281 | 58 | 5493 | 83 | 7903 | 78 | 7979 | 25 | 8236 | 8 |
| 1184 | 94 | 4282 | 58 | 5495 | 15 | 7909 | 35 | 7980 | 25 | 8237 | 8 |
| 1185 | 94 | 4283 | 58 | 5496 | 15 | 7910 | 35 | 7981 | 25 | 8238 | 8 |
| 1186 | 94 | 4284 | 57 | 5497 | 15 | 7914 | 35 | 7982 | 24 | 8242 | 87 |
| 1187 | 94 | 4285 | 57 | 5498 | 15 | 7915 | 35 | 7983 | 24 | 8243 | 87 |
| 1188 | 93 | 4286 | 57 | 6163 | 42 | 7918 | 34 | 7984 | 24 | 8244 | 73 |
| 1190 | 93 | 4287 | 57 | 6179 | 83 | 7919 | 34 | 7985 | 24 | 8245 | 73 |
| 1191 | 93 | 4288 | 56 | 6180 | 83 | 7923 | 34 | 7987 | 75 | 8246 | 43 |
| 1192 | 93 | 4289 | 56 | 6185 | 42 | 7924 | 47 | 7988 | 75 | 8247 | 43 |
| 1193 | 67 | 4290 | 56 | 6188 | 41 | 7925 | 47 | 7990 | 89 | 8252 | 8 |
| 1194 | 67 | 4291 | 56 | 6190 | 41 | 7926 | 34 | 7991 | 89 | 8253 | 7 |
| 1195 | 67 | 5404 | 92 | 6192 | 41 | 7928 | 79 | 8126 | 89 | 8254 | 7 |
| 1196 | 66 | 5405 | 92 | 6196 | 83 | 7929 | 78 | 8139 | 14 | 8255 | 7 |
| 1197 | 66 | 5422 | 91 | 6197 | 82 | 7931 | 98 | 8147 | 14 | 8257 | 7 |
| 1198 | 66 | 5428 | 87 | 6198 | 82 | 7932 | 97 | 8152 | 46 | 8258 | 6 |
| 1199 | 66 | 5429 | 86 | 6199 | 90 | 7933 | 97 | 8153 | 14 | 8259 | 6 |
| 2529 | 92 | 5430 | 86 | 6200 | 98 | 7934 | 77 | 8158 | 14 | 8260 | 6 |
| 2532 | 92 | 5434 | 22 | 6203 | 82 | 7935 | 77 | 8160 | 13 | 8261 | 6 |
| 2880 | 54 | 5435 | 22 | 6204 | 82 | 7936 | 77 | 8177 | 13 | 8262 | 5 |
| 2887 | 54 | 5437 | 21 | 6205 | 81 | 7937 | 77 | 8178 | 13 | 8263 | 5 |
| 2889 | 53 | 5439 | 21 | 6206 | 81 | 7938 | 33 | 8183 | 75 | 8264 | 43 |
| 2897 | 53 | 5440 | 21 | 6207 | 81 | 7939 | 33 | 8186 | 46 | 8265 | 43 |
| 2899 | 53 | 5441 | 21 | 6208 | 81 | 7940 | 33 | 8187 | 45 | 8267 | 72 |
| 2903 | 53 | 5442 | 86 | 6209 | 41 | 7941 | 33 | 8188 | 45 | 8268 | 72 |
| 2904 | 52 | 5443 | 91 | 6210 | 40 | 7942 | 32 | 8189 | 45 | 8269 | 72 |
| 2912 | 52 | 5444 | 99 | 6211 | 40 | 7943 | 32 | 8190 | 45 | 8270 | 5 |
| 2914 | 52 | 5445 | 86 | 6212 | 80 | 7944 | 32 | 8191 | 13 | 8271 | 5 |
| 2916 | 51 | 5447 | 99 | 6213 | 40 | 7945 | 76 | 8192 | 12 | 8272 | 4 |
| 2930 | 51 | 5449 | 91 | 6215 | 40 | 7946 | 76 | 8194 | 12 | 8273 | 4 |
| 2931 | 51 | 5450 | 91 | 6216 | 39 | 7947 | 76 | 8197 | 12 | 8274 | 4 |
| 2932 | 51 | 5451 | 90 | 6217 | 39 | 7948 | 76 | 8199 | 74 | 8275 | 4 |
| 2933 | 50 | 5452 | 90 | 6218 | 80 | 7949 | 32 | 8201 | 74 | 8276 | 3 |
| 2934 | 50 | 5453 | 85 | 6220 | 39 | 7950 | 31 | 8202 | 12 | 8277 | 3 |
| 2936 | 50 | 5455 | 85 | 6221 | 39 | 7951 | 31 | 8203 | 11 | 8278 | 3 |
| 2937 | 50 | 5456 | 85 | 6222 | 80 | 7952 | 31 | 8205 | 97 | 8279 | 3 |
| 3100 | 65 | 5457 | 85 | 6223 | 80 | 7953 | 31 | 8206 | 97 | 8281 | 72 |
| 3101 | 65 | 5459 | 84 | 6225 | 38 | 7954 | 30 | 8207 | 88 | | |
| 3102 | 65 | 5460 | 84 | 6226 | 38 | 7955 | 30 | 8208 | 88 | | |



Walter Binde Optik GmbH & Co. KG

Königstraße 134b | D-32427 Minden
Postfach 2160 | D-32378 Minden

Auftragsannahme: +49 (0)5 71 / 2 80 13
 +49 (0)5 71 / 2 80 14
Telefax: +49 (0)5 71 / 8 51 11
Nach Geschäftsschluss Anrufbeantworter

Bestellung: bestellung@binde-optik.de
Buchhaltung: fibu@binde-optik.de

www.binde-optik.de