



FASSUNGSKATALOG

# Frühjahr/Sommer '17

[WWW.BINDE-OPTIK.DE](http://WWW.BINDE-OPTIK.DE)



**Katalog ab 1. Januar 2017**

Es gelten die Verkaufs-, Lieferungs- und Zahlungsbedingungen der Walter Binde GmbH & Co. KG

**Walter Binde Optik GmbH & Co. KG**

Königstraße 134b | D-32427 Minden  
Postfach 2160 | D-32378 Minden

Auftragsannahme: +49 (0)5 71 / 2 80 13

+49 (0)5 71 / 2 80 14

Telefax: +49 (0)5 71 / 8 51 11

Nach Geschäftsschluss Anrufbeantworter

Bestellung: [bestellung@binde-optik.de](mailto:bestellung@binde-optik.de)

Buchhaltung: [fibu@binde-optik.de](mailto:fibu@binde-optik.de)

**[www.binde-optik.de](http://www.binde-optik.de)**

**Fassungen Titelseite**

oben (v.l.n.r.):

8188-12, Seite 38

8195-10, Seite 3

5445-08, Seite 77

5442-14, Seite 78

unten:

7914-16, Seite 20



|  |           |
|--|-----------|
| › LOOK & FEEL Damen Metall- und Cellfassungen                    | 3 – 17    |
| › LOOK & FEEL Herren Metall-, Beflex- und Cellfassungen          | 18 – 36   |
| › women Damen Metallfassungen                                    | 38 – 42   |
| › men Herren Metall-, Beflex- und Cellfassungen                  | 42 – 45   |
| › Jump Up  | 46 – 47   |
| › Jump Up Teens  | 48 – 50   |
| › Kids One   | 50 – 53   |
| › Skylight Titan   | 54 – 59   |
| › Readers  | 60 – 65   |
| › Start Up – Premium, Fashion, Classic, Readers, Basics          | 66 – 92   |
| › Werbung/Marketing  | 94 – 95   |
| › Werkstattbedarf  | 96 – 97   |
| › Zertifikat zur Biokompatibilität                               | 98        |
| › Allergieschutzbeschichtung, Rechtlicher Hinweis, Pflegehinweis | 99        |
| › AGB  | 100 – 101 |
| › Inhalt nach Modellnummern                                      | 102       |
| › Notizen  | 104       |

| Farb-Nr. | Farbe / Color   |
|----------|---|
| 01       | silber / silver   |
| 02       | gold / gold   |
| 03       | bi-color / gold & silver                                    |
| 04       | weiss / white   |
| 05       | rosa / rose, salmon-coloured, pink                          |
| 06       | gelb / yellow   |
| 07       | hellblau / light blue                                       |
| 08       | blau / blue   |
| 09       | orange, hellrot / orange, light red                         |
| 10       | rot, bordeaux / red, bordeaux                               |
| 11       | hellbraun, havanna / light brown, havanna                   |
| 12       | braun / brown   |
| 13       | hellgrau / light grey                                       |
| 14       | silberantik, gun, grau / silverantik, gun, grey, anthracite |
| 15       | grün / green  |
| 16       | schwarz / black   |
| 17       | lila, flieder / lilac                                       |

Hinter die Kulissen geschaut:

## Wie preiswerte Qualität entsteht.



**Qualität und Preis-Leistungsverhältnis sind im Produktmarketing extrem strapazierte Begriffe. Auch im Bereich Augenoptik werden sie von vielen Anbietern „inflationär“ eingesetzt. Doch oft bleibt Produkt-Qualität nur eine Behauptung. Anders beim Unternehmen Binde Optik, das für Qualität den Nachweis erbringt.**

Was genau ist mit „Qualität“ gemeint? Die Qualität einer Brille wird für denjenigen deutlich, der hinter die Kulissen schaut: Wie viele Arbeitsschritte sind für eine Farbbeschichtung notwendig? Wie aufwendig ist es, die richtigen Materialien für ein Modell auszuwählen bzw. zu kombinieren? Wie viel Zeit kostet es, die vielen Bauteile einer Brille zueinander zu bringen? Sind Design (auch ein Qualitätsaspekt!) und Konstruktion einer Fassung festgelegt, wird bei Binde Optik intensiv daran gearbeitet, die einzelnen Bauteile auszuwählen. Denn: Um die gesetzten Qualitätsstandards in der Produktion 100%-ig sicherzustellen, muss die Lohnfertigung in Asien die genauen Vorgaben des Mindener Großhändlers 1:1 umsetzen. Binde Optik überlässt nichts dem Zufall!

Es ist ein hoher Aufwand, die jeweiligen Einzelteile, wie z.B. Fassungsänderer, Scharniere, Stegstützen, Brückenteile usw. aus den Katalogen verschiedener europäischer Hersteller perfekt passend für ein bestimmtes Modell auszuwählen. Pro Fassung müssen jeweils 16-20 Einzelteile definiert werden. Die Fertigung einer Brille besteht nochmals aus unzähligen, zeitintensiven

Arbeitsschritten, von ca. 8-12 Lötungen über aufwendiges Reinigen der Rohfassung bis hin zum Verrunden und Entgraten der Teile.

Die zu verwendenden Bauteile müssen mit exakter Herstellernummer angegeben und alle Schritte für die Lohnfertigung minutiös beschrieben sein – ein Aufwand, der sich nicht automatisch in einem hohen Preis niederschlägt! Eine „preiswerte“ (günstige) Fassung von Binde Optik ist keineswegs „billig“ (weniger wertig), sondern preiswert im Sinne von wertig. Der Hintergrund: Bereits vor rd. 15 Jahren hat Binde Optik auch aufgrund eigener negativer Erfahrungen damit begonnen, in Sachen Qualität umzudenken und sich intensiv mit neuen Prozessen zu befassen. Die Erkenntnis: Es geht darum sich intensivst zu bemühen, d.h. selbst die richtigen Bauteile auswählen und exakt festlegen, dann ist gute Produkt-Qualität möglich! Die damals noch zeitintensiven Prozesse hat Binde Optik nach einigen Jahren immer mehr standardisiert und professionalisiert. Die Qualität wird von Binde Optik stetig upgedatet, zudem informieren die Bauteile-Hersteller regelmäßig über neue Fassungsänderer, Scharniere u.a. Thomas Burow, Leiter Entwicklung und Marketing/Vertrieb bei Binde Optik: „Binde Optik steht für preiswerte Fassungen. Aber unsere preiswerten Fassungen bieten dennoch ein exzellentes Preis-Leistungsverhältnis. Ein Kunde, der eine günstige Binde Optik-Brille erwirbt, hat somit auch hier mit Recht den Anspruch auf sehr gute Qualität.“

» Look & Feel Damen Metall- und Cellfassungen

LOOK & FEEL **8198**

**NEU**

LOOK & FEEL  
EYEWEAR COLLECTION



STAINLESS STEEL  
*premium selection*

- Größen 53-16  
Farben 10  
12  
15  
53  
16  
135  
36  
13

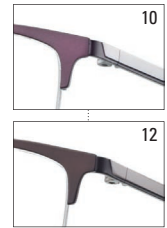

Farbe 15 Edelstahl

LOOK & FEEL **8197**

**NEU**

LOOK & FEEL  
EYEWEAR COLLECTION



STAINLESS STEEL  
*premium selection*

- Größen 53-16  
Farben 08  
10  
12  
53  
16  
135  
36  
16

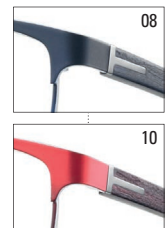

Farbe 12 Edelstahl, Federscharnier, Kunststoffbügel

LOOK & FEEL **8196**

**NEU**

LOOK & FEEL  
EYEWEAR COLLECTION



STAINLESS STEEL  
*premium selection*

- Größen 53-16  
Farben 10  
12  
14  
53  
16  
135  
35  
15

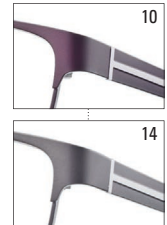

Farbe 12 Edelstahl, Federscharnier

LOOK & FEEL **8195**

**NEU**

LOOK & FEEL  
EYEWEAR COLLECTION



STAINLESS STEEL  
*premium selection*

- Größen 54-16  
Farben 10  
12  
17  
54  
16  
135  
33  
11

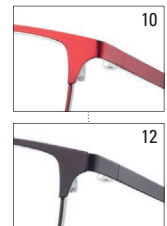

Farbe 17 Edelstahl

» Look & Feel Damen Metall- und Cellfassungen

LOOK & FEEL **8194**

**NEU**

LOOK & FEEL  
EYEWEAR COLLECTION



- Größen 54-16  
Farben 08  
10  
12  
54  
16  
135  
38  
12



Farbe 08 Edelstahl

STAINLESS STEEL  
*premium selection*

LOOK & FEEL **8192**

**NEU**

LOOK & FEEL  
EYEWEAR COLLECTION



- Größen 49-16  
Farben 10  
12  
16  
49  
16  
130  
33  
14

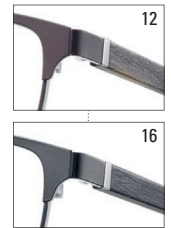

Farbe 10 Edelstahl, Federscharnier, Kunststoffbügel

STAINLESS STEEL  
*premium selection*

LOOK & FEEL **8191**

**NEU**

LOOK & FEEL  
EYEWEAR COLLECTION



- Größen 53-16  
Farben 10  
12  
16  
53  
16  
135  
36  
11

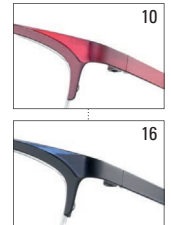

Farbe 12 Edelstahl

STAINLESS STEEL  
*premium selection*

LOOK & FEEL **8185**

LOOK & FEEL  
EYEWEAR COLLECTION



- Größen 53-17  
Farben 08  
12  
16  
53  
17  
135  
35  
16

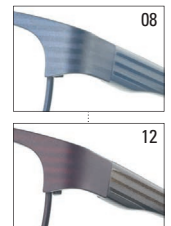

Farbe 16 Edelstahl, Kunststoffbügel

STAINLESS STEEL  
*premium selection*

» Look & Feel Damen Metall- und Cellfassungen

LOOK & FEEL **8184**



LOOK & FEEL  
EYEWEAR COLLECTION

Größen 55-16

Farben 08

15

17



55

16

140

38

17



08



17

Farbe 15 Edelstahl, Kunststoffbügel

STAINLESS STEEL  
*premium selection*

LOOK & FEEL **8181**



LOOK & FEEL  
EYEWEAR COLLECTION

Größen 54-16

Farben 10

12

16



54

16

135

36

12



10



16

Farbe 12 Edelstahl, Federscharnier

STAINLESS STEEL  
*premium selection*

LOOK & FEEL **8180**



LOOK & FEEL  
EYEWEAR COLLECTION

Größen 52-17

Farben 08

16

17



52

17

135

35

12



08



17

Farbe 16 Edelstahl, Federscharnier

STAINLESS STEEL  
*premium selection*

LOOK & FEEL **8179**



LOOK & FEEL  
EYEWEAR COLLECTION

Größen 54-17

Farben 10

12

15



54

17

135

36

16



10

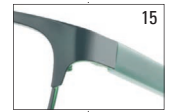

15

Farbe 12 Edelstahl, Federscharnier, Kunststoffbügel

STAINLESS STEEL  
*premium selection*



» Look & Feel Damen Metall- und Cellfassungen

LOOK & FEEL **8178**

LOOK & FEEL  
EYEWEAR COLLECTION



- Größen 53-17  
Farben 10  
15  
16  
53  
17  
135  
37  
12

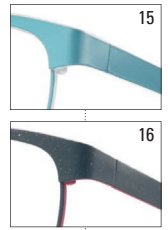

Farbe 10 Edelstahl, Federscharnier

STAINLESS STEEL  
*premium selection*

LOOK & FEEL **8177**

LOOK & FEEL  
EYEWEAR COLLECTION



- Größen 52-17  
Farben 08  
10  
12  
52  
17  
135  
37  
11

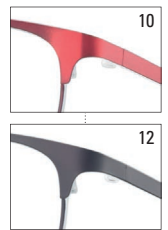

Farbe 08 Edelstahl

STAINLESS STEEL  
*premium selection*

LOOK & FEEL **8175**

LOOK & FEEL  
EYEWEAR COLLECTION



- Größen 52-16  
Farben 10  
12  
15  
52  
16  
135  
35  
16

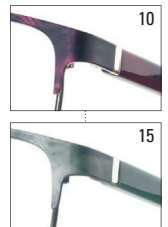

Farbe 12 Edelstahl, Federscharnier, Kunststoffbügel

STAINLESS STEEL  
*premium selection*

LOOK & FEEL **8174**

LOOK & FEEL  
EYEWEAR COLLECTION



- Größen 55-16  
Farben 10  
12  
16  
55  
16  
135  
35  
19

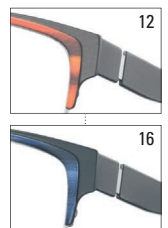

Farbe 10 Edelstahl, Federscharnier

STAINLESS STEEL  
*premium selection*



» Look & Feel Damen Metall- und Cellfassungen

LOOK & FEEL **8173**



LOOK & FEEL  
EYEWEAR COLLECTION

- Größen 54-17  
Farben 10  
12  
17  
54  
17  
135  
36  
16

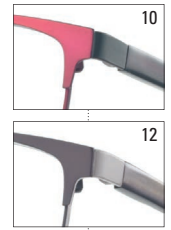

Farbe 17 Edelstahl, Federscharnier, Kunststoffbügel

STAINLESS STEEL  
*premium selection*

LOOK & FEEL **8172**



LOOK & FEEL  
EYEWEAR COLLECTION

- Größen 54-16  
Farben 10  
12  
16  
54  
16  
135  
35  
15

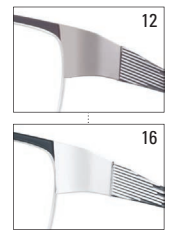

Farbe 10 Edelstahl, Federscharnier

STAINLESS STEEL  
*premium selection*

LOOK & FEEL **8170**



LOOK & FEEL  
EYEWEAR COLLECTION

- Größen 54-16  
Farben 12  
14  
16  
54  
16  
135  
38  
13

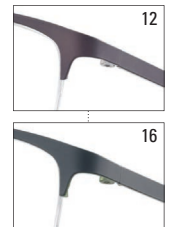

Farbe 14 Edelstahl

STAINLESS STEEL  
*premium selection*

LOOK & FEEL **8169**



LOOK & FEEL  
EYEWEAR COLLECTION

- Größen 52-16  
Farben 08  
10  
12  
52  
16  
135  
37  
15

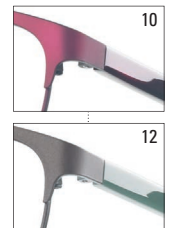

Farbe 08 Edelstahl, Kunststoffbügel

STAINLESS STEEL  
*premium selection*

» Look & Feel Damen Metall- und Cellfassungen

LOOK & FEEL **8168**

LOOK & FEEL  
EYEWEAR COLLECTION



STAINLESS STEEL  
*premium selection*

- Größen 54-16  
Farben 10  
12  
16  
54  
16  
135  
37  
15

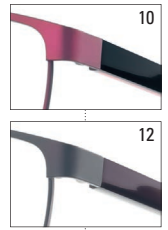

Farbe 16 Edelstahl, Kunststoffbügel

LOOK & FEEL **8161**

LOOK & FEEL  
EYEWEAR COLLECTION



STAINLESS STEEL  
*premium selection*

- Größen 53-16  
Farben 10  
12  
16  
53  
16  
135  
36  
17

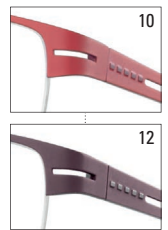

Farbe 16 Edelstahl, Federscharnier

LOOK & FEEL **8160**

LOOK & FEEL  
EYEWEAR COLLECTION



STAINLESS STEEL  
*premium selection*

- Größen 56-16  
Farben 10  
12  
16  
56  
16  
140  
36  
20

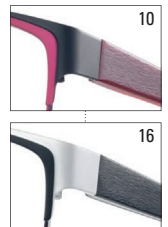

Farbe 12 Edelstahl, Federscharnier, Kunststoffbügel

LOOK & FEEL **8159**

LOOK & FEEL  
EYEWEAR COLLECTION



STAINLESS STEEL  
*premium selection*

- Größen 53-17  
Farben 08  
12  
16  
53  
17  
140  
37  
15

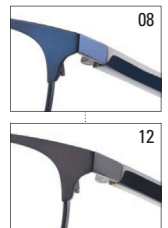

Farbe 16 Edelstahl, Kunststoffbügel

» Look & Feel Damen Metall- und Cellfassungen

LOOK & FEEL **8158**

LOOK & FEEL  
EYEWEAR COLLECTION



STAINLESS STEEL  
*premium selection*

- Größen 52-17  
Farben 10  
12  
14  
52  
17  
135  
37  
18

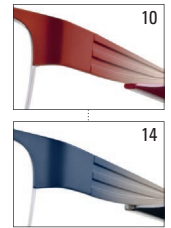

Farbe 12 Edelstahl, Federscharnier, Kunststoffbügel

LOOK & FEEL **8156**

LOOK & FEEL  
EYEWEAR COLLECTION



STAINLESS STEEL  
*premium selection*

- Größen 52-16  
Farben 10  
16  
17  
52  
16  
135  
35  
15

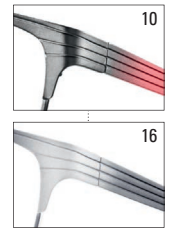

Farbe 17 Edelstahl, Federscharnier

LOOK & FEEL **8155**

LOOK & FEEL  
EYEWEAR COLLECTION



STAINLESS STEEL  
*premium selection*

- Größen 53-17  
Farben 08  
10  
16  
53  
17  
135  
35  
16

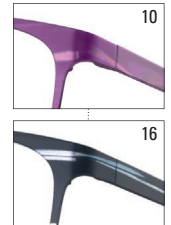

Farbe 08 Edelstahl, Federscharnier

LOOK & FEEL **8153**

LOOK & FEEL  
EYEWEAR COLLECTION



STAINLESS STEEL  
*premium selection*

- Größen 53-17  
Farben 08  
10  
16  
53  
17  
135  
37  
15

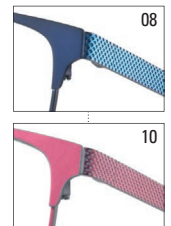

Farbe 16 Edelstahl, Federscharnier

» Look & Feel Damen Metall- und Cellfassungen

LOOK & FEEL **8147**

LOOK & FEEL  
EYEWEAR COLLECTION



STAINLESS STEEL  
*premium selection*

- Größen 53-15  
Farben 12  
14  
16  
53  
15  
135  
34  
15

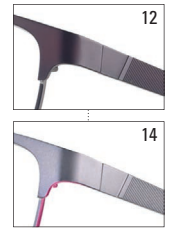

Farbe 16 Edelstahl, Federscharnier

LOOK & FEEL **8145**

LOOK & FEEL  
EYEWEAR COLLECTION



STAINLESS STEEL  
*premium selection*

- Größen 53-16  
Farben 12  
16  
17  
53  
16  
135  
35  
21

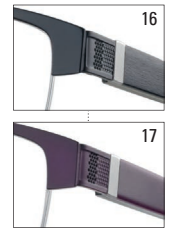

Farbe 12 Edelstahl, Federscharnier, Kunststoffbügel

LOOK & FEEL **8143**

LOOK & FEEL  
EYEWEAR COLLECTION



STAINLESS STEEL  
*premium selection*

- Größen 53-17  
Farben 08  
10  
16  
53  
17  
135  
35  
16

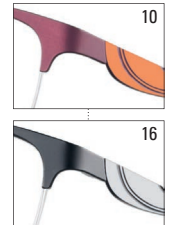

Farbe 08 Edelstahl, Federscharnier

LOOK & FEEL **8142**

LOOK & FEEL  
EYEWEAR COLLECTION



STAINLESS STEEL  
*premium selection*

- Größen 53-17  
Farben 10  
12  
14  
53  
17  
135  
36  
16

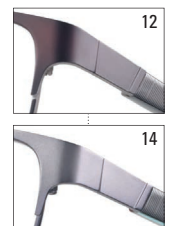

Farbe 10 Edelstahl, Federscharnier, Kunststoffbügel

› Look & Feel Damen Metall- und Cellfassungen

LOOK & FEEL **8141**



LOOK & FEEL  
EYEWEAR COLLECTION

- Größen 53-17  
Farben 10  
12  
16  
53  
17  
135  
37  
18

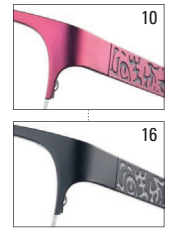

Farbe 12 Edelstahl, Federscharnier

STAINLESS STEEL  
*premium selection*

LOOK & FEEL **8140**



LOOK & FEEL  
EYEWEAR COLLECTION

- Größen 52-17  
Farben 08  
16  
17  
52  
17  
135  
36  
16

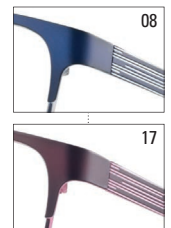

Farbe 16 Edelstahl, Federscharnier

STAINLESS STEEL  
*premium selection*

LOOK & FEEL **8139**



LOOK & FEEL  
EYEWEAR COLLECTION

- Größen 52-17  
Farben 12  
14  
17  
52  
17  
135  
34  
16

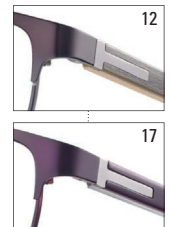

Farbe 14 Edelstahl, Federscharnier, Kunststoffbügel

STAINLESS STEEL  
*premium selection*

LOOK & FEEL **8138**



LOOK & FEEL  
EYEWEAR COLLECTION

- Größen 54-16  
Farben 12  
16  
17  
54  
16  
135  
35  
17

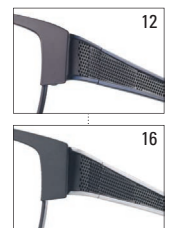

Farbe 17 Edelstahl, Federscharnier

STAINLESS STEEL  
*premium selection*



» Look & Feel Damen Metall- und Cellfassungen

LOOK & FEEL **8136**

LOOK & FEEL  
EYEWEAR COLLECTION



STAINLESS STEEL  
*premium selection*

- Größen 53-17  
Farben 10  
12  
17  
53  
17  
135  
34  
17

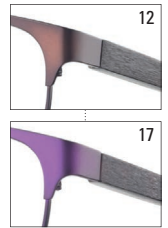

Farbe 10 Edelstahl, Federscharnier, Kunststoffbügel

LOOK & FEEL **8135**

LOOK & FEEL  
EYEWEAR COLLECTION



STAINLESS STEEL  
*premium selection*

- Größen 53-16  
Farben 14  
16  
17  
53  
16  
135  
32  
17

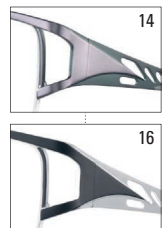

Farbe 17 Edelstahl, Federscharnier

LOOK & FEEL **8131**

LOOK & FEEL  
EYEWEAR COLLECTION



STAINLESS STEEL  
*premium selection*

- Größen 53-16  
Farben 12  
14  
17  
53  
16  
135  
34  
13

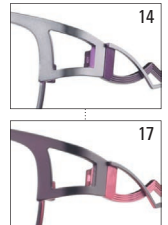

Farbe 12 Edelstahl

LOOK & FEEL **8128**

LOOK & FEEL  
EYEWEAR COLLECTION



STAINLESS STEEL  
*premium selection*

- Größen 52-16  
Farben 08  
10  
17  
52  
16  
135  
34  
16

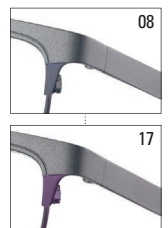

Farbe 10 Edelstahl



» Look & Feel Damen Metall- und Cellfassungen

LOOK & FEEL **8122**



LOOK & FEEL  
EYEWEAR COLLECTION

- Größen 49-17  
Farben 12  
16  
49  
17  
135  
31  
20



12

Farbe 16 Edelstahl, Federscharnier

STAINLESS STEEL  
*premium selection*

LOOK & FEEL **8121**



LOOK & FEEL  
EYEWEAR COLLECTION

- Größen 50-16  
Farben 12  
16  
17  
50  
16  
130  
33  
16



12



17

Farbe 16 Edelstahl, Federscharnier

STAINLESS STEEL  
*premium selection*

TOP PREIS LEISTUNG

LOOK & FEEL **8111**



LOOK & FEEL  
EYEWEAR COLLECTION

- Größen 51-17  
Farben 08  
10  
14  
15  
51  
17  
135  
35  
18



10

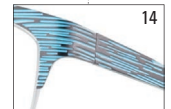

14

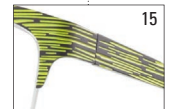

15

Farbe 08 Edelstahl, Federscharnier

STAINLESS STEEL  
*premium selection*

LOOK & FEEL **5441**

**NEU**



LOOK & FEEL  
EYEWEAR COLLECTION

- Größen 54-16  
Farben 10  
12  
16  
54  
16  
135  
39  
11



10



16

Farbe 12 Zelluloseacetat, Metallbügel

XTRA LIGHT ACETATE  
*premium selection*

» Look & Feel Damen Metall- und Cellfassungen

LOOK & FEEL **5440**

**NEU**

LOOK & FEEL  
EYEWEAR COLLECTION



XTRA LIGHT ACETATE  
*premium selection*

- Größen 53-12  
Farben 10  
12  
16  
53  
12  
135  
35  
14

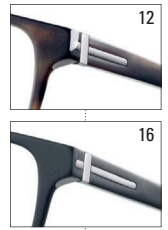

Farbe 10 Zelluloseacetat

LOOK & FEEL **5439**

**NEU**

LOOK & FEEL  
EYEWEAR COLLECTION



XTRA LIGHT ACETATE  
*premium selection*

- Größen 55-15  
Farben 11  
12  
16  
55  
15  
135  
39  
14

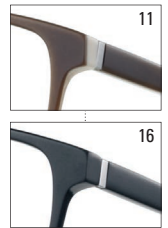

Farbe 12 Zelluloseacetat, Federscharnier

LOOK & FEEL **5437**

**NEU**

LOOK & FEEL  
EYEWEAR COLLECTION



XTRA LIGHT ACETATE  
*premium selection*

- Größen 48-18  
Farben 10  
12  
16  
48  
18  
135  
38  
10

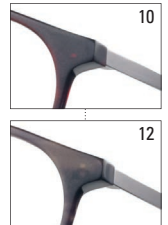

Farbe 16 Zelluloseacetat, Metallbügel

LOOK & FEEL **5436**

LOOK & FEEL  
EYEWEAR COLLECTION



XTRA LIGHT ACETATE  
*premium selection*

- Größen 50-16  
Farben 10  
15  
16  
50  
16  
135  
35  
13

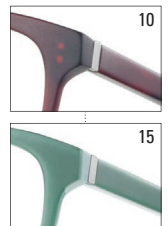

Farbe 16 Zelluloseacetat

» Look & Feel Damen Metall- und Cellfassungen

LOOK & FEEL **5435**



LOOK & FEEL  
EYEWEAR COLLECTION

Größen 54-16

- Farben 10  
12  
17  
54  
16  
135  
39  
15

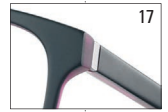

Farbe 12 Zelluloseacetat

XTRA LIGHT ACETATE  
premium selection

LOOK & FEEL **5434**



LOOK & FEEL  
EYEWEAR COLLECTION

Größen 53-16

- Farben 10  
12  
15  
16  
53  
16  
135  
34  
16



Farbe 12 Zelluloseacetat

XTRA LIGHT ACETATE  
premium selection

LOOK & FEEL **5432**



LOOK & FEEL  
EYEWEAR COLLECTION

Größen 54-15

- Farben 08  
10  
12  
16  
54  
15  
135  
36  
14



Farbe 16 Zelluloseacetat

XTRA LIGHT ACETATE  
premium selection

LOOK & FEEL **5431**



LOOK & FEEL  
EYEWEAR COLLECTION

Größen 54-14

- Farben 10  
12  
15  
16  
54  
14  
140  
35  
16



Farbe 10 Zelluloseacetat

XTRA LIGHT ACETATE  
premium selection

» Look & Feel Damen Metall- und Cellfassungen

LOOK & FEEL **5424**

LOOK & FEEL  
EYEWEAR COLLECTION



- Größen 51-16  
Farben 10  
12  
16  
51  
16  
140  
36  
19

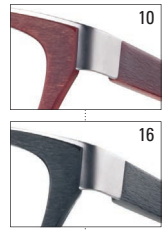

HAND MADE ACETATE  
*premium selection*

Farbe 12 Zelluloseacetat, Federscharnier

LOOK & FEEL **5414**

LOOK & FEEL  
EYEWEAR COLLECTION



- Größen 53-17  
Farben 10  
14  
16  
53  
17  
135  
37  
17

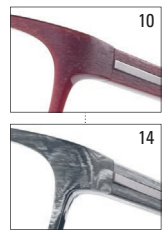

HAND MADE ACETATE  
*premium selection*

Farbe 16 Zelluloseacetat, Federscharnier

LOOK & FEEL **5413**

LOOK & FEEL  
EYEWEAR COLLECTION



- Größen 52-15  
Farben 10  
12  
16  
52  
15  
140  
35  
17

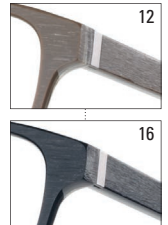

HAND MADE ACETATE  
*premium selection*

Farbe 10 Zelluloseacetat, Federscharnier

LOOK & FEEL **5411**

LOOK & FEEL  
EYEWEAR COLLECTION



- Größen 53-16  
Farben 12  
14  
17  
53  
16  
135  
35  
16

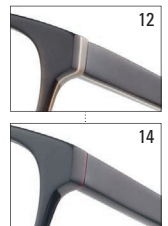

HAND MADE ACETATE  
*premium selection*

Farbe 17 Zelluloseacetat, Federscharnier

› Look & Feel Damen Metall- und Cellfassungen

LOOK & FEEL **5410**



LOOK & FEEL  
EYEWEAR COLLECTION

Größen 54-16

- Farben 10  
12  
16  
54  
16  
135  
34  
15



HAND MADE ACETATE  
*premium selection*

Farbe 10 Zelluloseacetat, Federscharnier

LOOK & FEEL **5406**



LOOK & FEEL  
EYEWEAR COLLECTION

Größen 50-15

- Farben 10  
12  
16  
50  
15  
135  
32  
15



HAND MADE ACETATE  
*premium selection*

Farbe 12 Zelluloseacetat, Federscharnier

LOOK & FEEL **5389**



LOOK & FEEL  
EYEWEAR COLLECTION

Größen 51-16

- Farben 10  
12  
16  
51  
16  
135  
34  
18



HAND MADE ACETATE  
*premium selection*

Farbe 12 Zelluloseacetat, Federscharnier

TOP PREIS LEISTUNG



» Look & Feel Herren Metall-, Beflex- und Cellfassungen

LOOK & FEEL 7926

**NEU**

LOOK & FEEL  
EYEWEAR COLLECTION



STAINLESS STEEL  
*premium selection*

- Größen 53-17  
Farben 08  
12  
16  
53  
17  
140  
32  
18

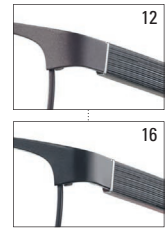

Farbe 08 Edelstahl, Federscharnier, Kunststoffbügel

LOOK & FEEL 7923

**NEU**

LOOK & FEEL  
EYEWEAR COLLECTION



STAINLESS STEEL  
*premium selection*

- Größen 55-19  
Farben 08  
14  
16  
55  
19  
140  
34  
17

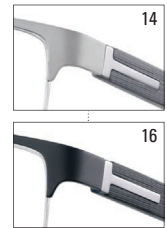

Farbe 08 Edelstahl, Federscharnier, Kunststoffbügel

LOOK & FEEL 7920

**NEU**

LOOK & FEEL  
EYEWEAR COLLECTION



STAINLESS STEEL  
*premium selection*

- Größen 58-17  
Farben 08  
12  
14  
58  
17  
145  
36  
18

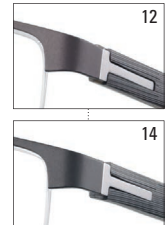

Farbe 08 Edelstahl, Federscharnier, Kunststoffbügel

LOOK & FEEL 7919

**NEU**

LOOK & FEEL  
EYEWEAR COLLECTION



STAINLESS STEEL  
*premium selection*

- Größen 56-16  
Farben 08  
14  
16  
56  
16  
140  
34  
14

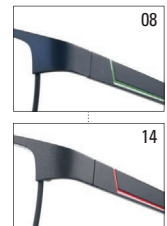

Farbe 16 Edelstahl, Federscharnier



» Look & Feel Herren Metall-, Beflex- und Cellfassungen

LOOK & FEEL **7918**

**NEU**

LOOK & FEEL  
EYEWEAR COLLECTION



STAINLESS STEEL  
*premium selection*

- Größen 55-17  
Farben 08  
14  
16  
55  
17  
140  
34  
18

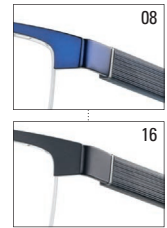

Farbe 14 Edelstahl, Federscharnier, Kunststoffbügel

LOOK & FEEL **7917**

**NEU**

LOOK & FEEL  
EYEWEAR COLLECTION



STAINLESS STEEL  
*premium selection*

- Größen 57-18  
Farben 08  
12  
16  
57  
18  
145  
33  
19

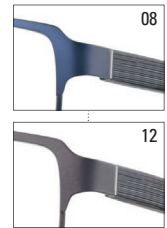

Farbe 16 Edelstahl, Federscharnier, Kunststoffbügel

LOOK & FEEL **7916**

**NEU**

LOOK & FEEL  
EYEWEAR COLLECTION



STAINLESS STEEL  
*premium selection*

- Größen 55-18  
Farben 12  
14  
16  
55  
18  
140  
36  
12

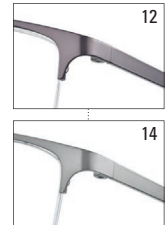

Farbe 16 Edelstahl

LOOK & FEEL **7915**

**NEU**

LOOK & FEEL  
EYEWEAR COLLECTION



STAINLESS STEEL  
*premium selection*

- Größen 56-18  
Farben 08  
14  
16  
56  
18  
140  
36  
16

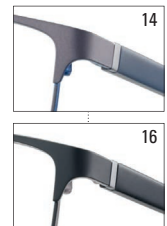

Farbe 08 Edelstahl, Federscharnier, Kunststoffbügel

» Look & Feel Herren Metall-, Beflex- und Cellfassungen

LOOK & FEEL **7914**

**NEU**

LOOK & FEEL  
EYEWEAR COLLECTION



STAINLESS STEEL  
*premium selection*

- Größen 46-20  
Farben 12  
14  
16  
46  
20  
140  
38  
12

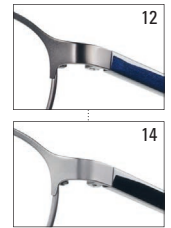

Farbe 16 Edelstahl, Kunststoffbügel

LOOK & FEEL **7913**

**NEU**

LOOK & FEEL  
EYEWEAR COLLECTION



BEFLEX  
STAINLESS STEEL

- Größen 49-19  
Farben 12  
14  
16  
49  
19  
140  
36  
9

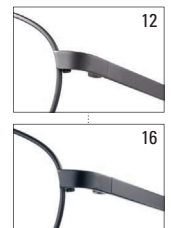

Farbe 14 Edelstahl, BEFLEX Memorybrücke

LOOK & FEEL **7912**

LOOK & FEEL  
EYEWEAR COLLECTION



STAINLESS STEEL  
*premium selection*

- Größen 58-17  
Farben 08  
14  
16  
58  
17  
140  
36  
20

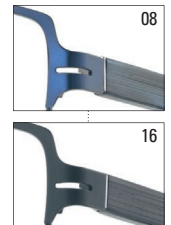

Farbe 14 Edelstahl, Federscharnier, Kunststoffbügel

LOOK & FEEL **7911**

LOOK & FEEL  
EYEWEAR COLLECTION



XTRA LIGHT ACETATE  
*premium selection*

- Größen 54-16  
Farben 08  
12  
16  
54  
16  
140  
36  
20

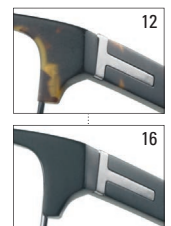

Farbe 08 Zelluloseacetat, Kombifassung

› Look & Feel Herren Metall-, Beflex- und Cellfassungen

LOOK & FEEL 7910



LOOK & FEEL  
EYEWEAR COLLECTION

Größen 58-18

Farben 08

12

14



36

19



08



14

STAINLESS STEEL  
*premium selection*

Farbe 12 Edelstahl, Federscharnier, Kunststoffbügel

LOOK & FEEL 7909



LOOK & FEEL  
EYEWEAR COLLECTION

Größen 54-18

Farben 08

14

16



33

16



14



16

STAINLESS STEEL  
*premium selection*

Farbe 08 Edelstahl, Federscharnier, Kunststoffbügel

LOOK & FEEL 7908



LOOK & FEEL  
EYEWEAR COLLECTION

Größen 53-18

Farben 12

14

16



30

16



12

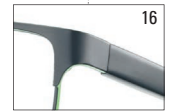

16

STAINLESS STEEL  
*premium selection*

Farbe 14 Edelstahl, Federscharnier, Kunststoffbügel

LOOK & FEEL 7907



LOOK & FEEL  
EYEWEAR COLLECTION

Größen 56-18

Farben 08

12

16



39

16



08



12

STAINLESS STEEL  
*premium selection*

Farbe 16 Edelstahl, Federscharnier

» Look & Feel Herren Metall-, Beflex- und Cellfassungen

LOOK & FEEL **7906**

LOOK & FEEL  
EYEWEAR COLLECTION



- Größen 54-17  
Farben 08  
12  
16  
54  
17  
140  
35  
16

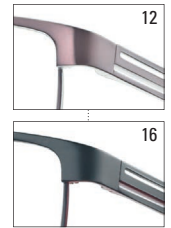

Farbe 08 Edelstahl, Federscharnier

STAINLESS STEEL  
*premium selection*

LOOK & FEEL **7905**

LOOK & FEEL  
EYEWEAR COLLECTION



- Größen 55-19  
Farben 08  
12  
16  
55  
19  
140  
36  
19

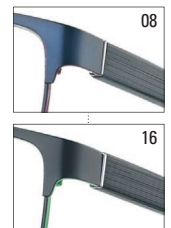

Farbe 12 Edelstahl, Federscharnier, Kunststoffbügel

STAINLESS STEEL  
*premium selection*

LOOK & FEEL **7904**

LOOK & FEEL  
EYEWEAR COLLECTION



- Größen 55-19  
Farben 08  
09  
16  
55  
19  
140  
35  
18

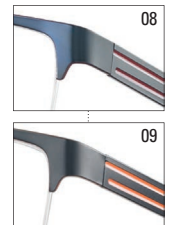

Farbe 16 Edelstahl, Federscharnier

STAINLESS STEEL  
*premium selection*

LOOK & FEEL **7895**

LOOK & FEEL  
EYEWEAR COLLECTION



- Größen 54-18  
Farben 08  
12  
16  
54  
18  
140  
34  
17

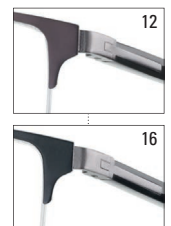

Farbe 08 Edelstahl, Kunststoffbügel

STAINLESS STEEL  
*premium selection*

› Look & Feel Herren Metall-, Beflex- und Cellfassungen

LOOK & FEEL **7888**



LOOK & FEEL  
EYEWEAR COLLECTION

- Größen 49-19  
Farben 12  
14  
16  
49  
19  
140  
37  
16

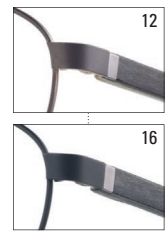

Farbe 14 Edelstahl, Federscharnier, Kunststoffbügel

STAINLESS STEEL  
*premium selection*

LOOK & FEEL **7887**



LOOK & FEEL  
EYEWEAR COLLECTION

- Größen 55-18  
Farben 08  
14  
16  
55  
18  
140  
36  
18

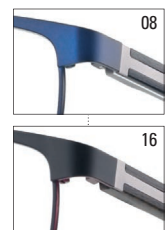

Farbe 14 Edelstahl, Federscharnier, Kunststoffbügel

STAINLESS STEEL  
*premium selection*

LOOK & FEEL **7886**



LOOK & FEEL  
EYEWEAR COLLECTION

- Größen 55-17  
Farben 08  
14  
16  
55  
17  
140  
36  
17

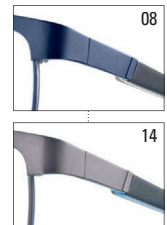

Farbe 16 Edelstahl, Federscharnier, Kunststoffbügel

STAINLESS STEEL  
*premium selection*

LOOK & FEEL **7883**



LOOK & FEEL  
EYEWEAR COLLECTION

- Größen 57-18  
Farben 08  
12  
16  
57  
18  
145  
38  
18

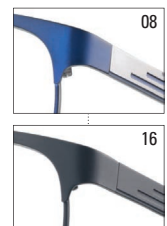

Farbe 12 Edelstahl, Federscharnier

STAINLESS STEEL  
*premium selection*



» Look & Feel Herren Metall-, Beflex- und Cellfassungen

LOOK & FEEL **7882**



LOOK & FEEL  
EYEWEAR COLLECTION

- Größen 57-18  
Farben 08  
14  
16  
57  
18  
140  
35  
20

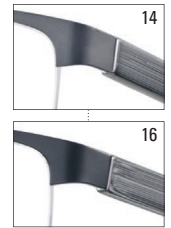

Farbe 08 Edelstahl, Federscharnier, Kunststoffbügel

STAINLESS STEEL  
*premium selection*

LOOK & FEEL **7881**



LOOK & FEEL  
EYEWEAR COLLECTION

- Größen 57-18  
Farben 12  
14  
16  
57  
18  
140  
37  
20

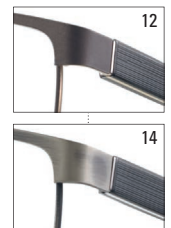

Farbe 16 Edelstahl, Federscharnier, Kunststoffbügel

STAINLESS STEEL  
*premium selection*

LOOK & FEEL **7880**



LOOK & FEEL  
EYEWEAR COLLECTION

- Größen 57-18  
Farben 12  
14  
16  
57  
18  
140  
36  
17

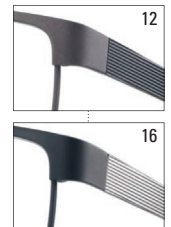

Farbe 14 Edelstahl, Federscharnier, Kunststoffbügel

STAINLESS STEEL  
*premium selection*

LOOK & FEEL **7879**



LOOK & FEEL  
EYEWEAR COLLECTION

- Größen 48-16  
Farben 08  
14  
16  
48  
16  
135  
30  
17

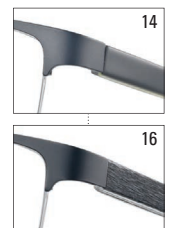

Farbe 08 Edelstahl, Federscharnier, Kunststoffbügel, BEFLEX Memorybrücke

BEFLEX  
STAINLESS STEEL



› Look & Feel Herren Metall-, Beflex- und Cellfassungen

LOOK & FEEL **7878**



LOOK & FEEL  
EYEWEAR COLLECTION

- Größen 53-18  
Farben 12  
14  
16  
53  
18  
140  
28  
18

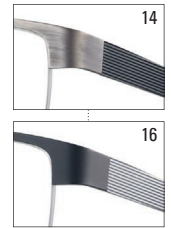

Farbe 12 Edelstahl, Federscharnier, BEFLEX Memorybrücke

LOOK & FEEL **7877**



LOOK & FEEL  
EYEWEAR COLLECTION

- Größen 53-18  
Farben 08  
14  
16  
53  
18  
140  
30  
18

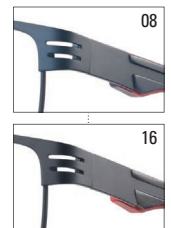

Farbe 14 Edelstahl, Federscharnier, BEFLEX Memorybrücke

LOOK & FEEL **7859**



LOOK & FEEL  
EYEWEAR COLLECTION

- Größen 58-18  
Farben 08  
12  
16  
58  
18  
145  
37  
18

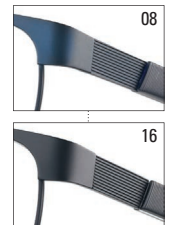

Farbe 12 Edelstahl, Federscharnier

STAINLESS STEEL  
*premium selection*

LOOK & FEEL **7858**



LOOK & FEEL  
EYEWEAR COLLECTION

- Größen 54-17  
Farben 08  
14  
16  
54  
17  
140  
34  
19

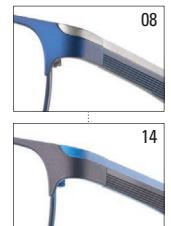

Farbe 16 Edelstahl, Federscharnier

STAINLESS STEEL  
*premium selection*

» Look & Feel Herren Metall-, Beflex- und Cellfassungen

LOOK & FEEL **7857**

LOOK & FEEL  
EYEWEAR COLLECTION



STAINLESS STEEL  
*premium selection*

- Größen 52-18  
Farben 08  
14  
16  
52  
18  
140  
33  
20

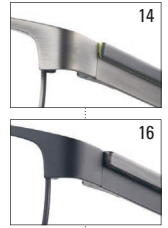

Farbe 08 Edelstahl, Federscharnier

LOOK & FEEL **7856**

LOOK & FEEL  
EYEWEAR COLLECTION



STAINLESS STEEL  
*premium selection*

- Größen 56-18  
Farben 08  
12  
14  
56  
18  
140  
34  
21

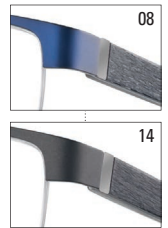

Farbe 12 Edelstahl, Federscharnier, Kunststoffbügel

LOOK & FEEL **7853**

LOOK & FEEL  
EYEWEAR COLLECTION



STAINLESS STEEL  
*premium selection*

- Größen 49-18  
Farben 12  
14  
16  
49  
18  
140  
38  
18

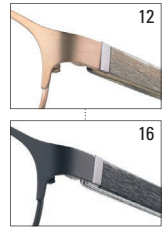

Farbe 14 Edelstahl, Federscharnier, Kunststoffbügel

LOOK & FEEL **7852**

LOOK & FEEL  
EYEWEAR COLLECTION



STAINLESS STEEL  
*premium selection*

- Größen 55-18  
Farben 12  
14  
16  
55  
18  
140  
33  
11

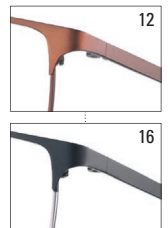

Farbe 14 Edelstahl

› Look & Feel Herren Metall-, Beflex- und Cellfassungen

LOOK & FEEL **7842**



LOOK & FEEL  
EYEWEAR COLLECTION

- Größen 53-18  
Farben 12  
14  
16  
53  
18  
140  
33  
23

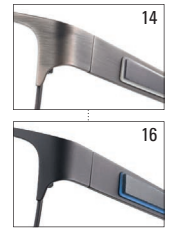

Farbe 12 Edelstahl, Federscharnier, BEFLEX Memorybrücke

LOOK & FEEL **7841**



LOOK & FEEL  
EYEWEAR COLLECTION

- Größen 52-18  
Farben 08  
16  
52  
18  
140  
33  
23



Farbe 16 Edelstahl, Federscharnier, Kunststoffbügel, BEFLEX Memorybrücke

LOOK & FEEL **7839**



LOOK & FEEL  
EYEWEAR COLLECTION

- Größen 54-18  
Farben 12  
14  
16  
54  
18  
140  
32  
20

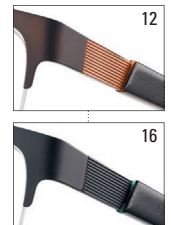

Farbe 14 Edelstahl, Federscharnier

STAINLESS STEEL  
*premium selection*

LOOK & FEEL **7838**



LOOK & FEEL  
EYEWEAR COLLECTION

- Größen 55-18  
Farben 08  
12  
14  
55  
18  
140  
35  
19

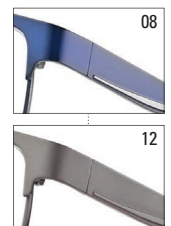

Farbe 14 Edelstahl, Federscharnier

STAINLESS STEEL  
*premium selection*

» Look & Feel Herren Metall-, Beflex- und Cellfassungen

LOOK & FEEL **7836**



LOOK & FEEL  
EYEWEAR COLLECTION

- Größen 58-17  
Farben 08  
12  
16  
58  
17  
145  
36  
22

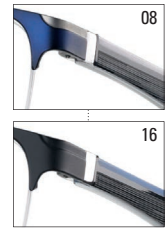

STAINLESS STEEL  
*premium selection*

Farbe 12 Edelstahl, Federscharnier, Kunststoffbügel

LOOK & FEEL **7834**



LOOK & FEEL  
EYEWEAR COLLECTION

- Größen 58-18  
Farben 12  
14  
58  
18  
145  
36  
20



BEFLEX  
STAINLESS STEEL

Farbe 14 Edelstahl, Federscharnier, Kunststoffbügel, BEFLEX Memorybrücke

LOOK & FEEL **7833**



LOOK & FEEL  
EYEWEAR COLLECTION

- Größen 59-17  
Farben 08  
14  
16  
59  
17  
145  
37  
20

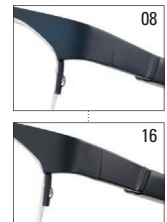

BEFLEX  
STAINLESS STEEL

Farbe 14 Edelstahl, Federscharnier, BEFLEX Memorybrücke

LOOK & FEEL **7832**



LOOK & FEEL  
EYEWEAR COLLECTION

- Größen 56-19  
Farben 08  
14  
16  
56  
19  
140  
35  
23

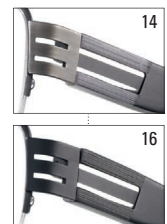

BEFLEX  
STAINLESS STEEL

Farbe 08 Edelstahl, Federscharnier, Kunststoffbügel, BEFLEX Memorybrücke

› Look & Feel Herren Metall-, Beflex- und Cellfassungen

LOOK & FEEL **7815**

LOOK & FEEL  
EYEWEAR COLLECTION



- Größen 56-17  
Farben 08  
09  
15  
56  
17  
140  
33  
14

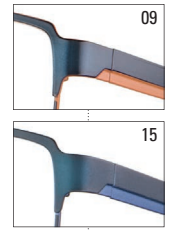

Farbe 08 Edelstahl, Federscharnier

STAINLESS STEEL  
*premium selection*

LOOK & FEEL **7808**

LOOK & FEEL  
EYEWEAR COLLECTION



- Größen 59-18  
Farben 12  
14  
16  
59  
18  
145  
37  
21

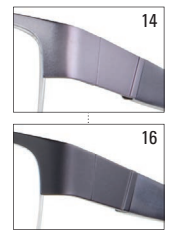

Farbe 12 Edelstahl, Federscharnier, Kunststoffbügel

STAINLESS STEEL  
*premium selection*

LOOK & FEEL **7800**

LOOK & FEEL  
EYEWEAR COLLECTION



- Größen 58-18  
Farben 08  
12  
14  
58  
18  
140  
36  
22

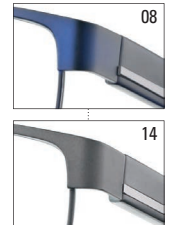

Farbe 12 Edelstahl, Federscharnier, Kunststoffbügel

STAINLESS STEEL  
*premium selection*

LOOK & FEEL **7792**

LOOK & FEEL  
EYEWEAR COLLECTION



- Größen 55-17  
Farben 12  
14  
55  
17  
140  
35  
24



Farbe 12 Edelstahl, Federscharnier, Kunststoffbügel

STAINLESS STEEL  
*premium selection*



» Look & Feel Herren Metall-, Beflex- und Cellfassungen

LOOK & FEEL **7772**

LOOK & FEEL  
EYEWEAR COLLECTION



- Größen 55-18  
Farben 08  
14  
55  
18  
140  
33  
17



Farbe 14 Federscharnier, TR 90 Bügel, BEFLEX Memorybrücke

LOOK & FEEL **6194**

**NEU**

LOOK & FEEL  
EYEWEAR COLLECTION



- Größen 54-16  
Farben 08  
10  
16  
54  
16  
140  
36  
10



Farbe 10 Zelluloseacetat, Metallbügel

LOOK & FEEL **6193**

**NEU**

LOOK & FEEL  
EYEWEAR COLLECTION



- Größen 49-17  
Farben 08  
12  
16  
49  
17  
140  
40  
14



Farbe 12 Zelluloseacetat, Federscharnier

LOOK & FEEL **6192**

**NEU**

LOOK & FEEL  
EYEWEAR COLLECTION



- Größen 56-16  
Farben 08  
12  
16  
56  
16  
145  
40  
16



Farbe 16 Zelluloseacetat, Federscharnier

› Look & Feel Herren Metall-, Beflex- und Cellfassungen

LOOK & FEEL **6191**

**NEU**

LOOK & FEEL  
EYEWEAR COLLECTION



- Größen 55-16  
Farben 08  
12  
16  
55  
16  
145  
33  
14

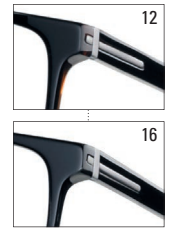

Farbe 08 Zelluloseacetat, Federscharnier

XTRA LIGHT ACETATE  
*premium selection*

LOOK & FEEL **6190**

LOOK & FEEL  
EYEWEAR COLLECTION



- Größen 54-15  
Farben 08  
10  
16  
54  
15  
140  
34  
14

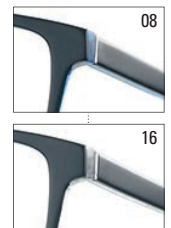

Farbe 10 Zelluloseacetat, Federscharnier

XTRA LIGHT ACETATE  
*premium selection*

LOOK & FEEL **6189**

LOOK & FEEL  
EYEWEAR COLLECTION



- Größen 56-15  
Farben 10  
12  
16  
56  
15  
140  
36  
17

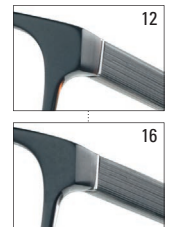

Farbe 10 Zelluloseacetat, Federscharnier

XTRA LIGHT ACETATE  
*premium selection*

LOOK & FEEL **6188**

LOOK & FEEL  
EYEWEAR COLLECTION



- Größen 54-16  
Farben 08  
12  
14  
16  
54  
16  
140  
32  
16

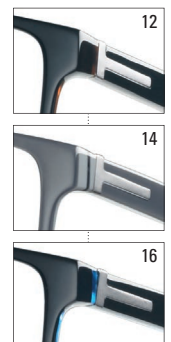

Farbe 08 Zelluloseacetat, Federscharnier

XTRA LIGHT ACETATE  
*premium selection*

» Look & Feel Herren Metall-, Beflex- und Cellfassungen

LOOK & FEEL **6187**

LOOK & FEEL  
EYEWEAR COLLECTION



XTRA LIGHT ACETATE  
*premium selection*

Größen 54-16

Farben 08

12

14

16

54

16

140

36

14

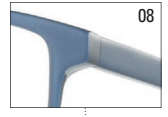

08

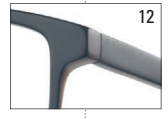

12



14

Farbe 16 Zelluloseacetat, Federscharnier

LOOK & FEEL **6186**

LOOK & FEEL  
EYEWEAR COLLECTION



XTRA LIGHT ACETATE  
*premium selection*

Größen 57-15

Farben 08

12

16

57

15

140

38

18

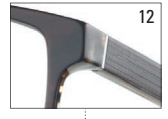

12



16

Farbe 08 Zelluloseacetat, Federscharnier

LOOK & FEEL **6185**

LOOK & FEEL  
EYEWEAR COLLECTION



XTRA LIGHT ACETATE  
*premium selection*

Größen 53-17

Farben 08

14

16

53

17

140

31

14



14

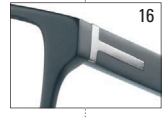

16

Farbe 08 Zelluloseacetat

LOOK & FEEL **6184**

LOOK & FEEL  
EYEWEAR COLLECTION



XTRA LIGHT ACETATE  
*premium selection*

Größen 56-17

Farben 08

12

14

56

17

140

36

15



08



14

Farbe 12 Zelluloseacetat

» Look & Feel Herren Metall-, Beflex- und Cellfassungen

LOOK & FEEL **6183**

LOOK & FEEL  
EYEWEAR COLLECTION



XTRA LIGHT ACETATE  
*premium selection*

- Größen 54-16  
Farben 08  
14  
16  
54  
16  
140  
33  
14

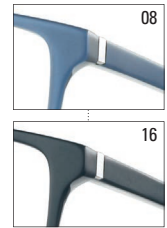

Farbe 14 Zelluloseacetat

LOOK & FEEL **6182**

LOOK & FEEL  
EYEWEAR COLLECTION



XTRA LIGHT ACETATE  
*premium selection*

- Größen 54-15  
Farben 08  
10  
12  
16  
54  
15  
140  
34  
16

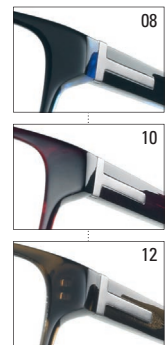

Farbe 16 Zelluloseacetat

LOOK & FEEL **6181**

LOOK & FEEL  
EYEWEAR COLLECTION



XTRA LIGHT ACETATE  
*premium selection*

- Größen 54-16  
Farben 08  
12  
14  
16  
54  
16  
140  
35  
15

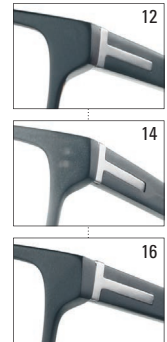

Farbe 08 Zelluloseacetat

LOOK & FEEL **6170**

LOOK & FEEL  
EYEWEAR COLLECTION



HAND MADE ACETATE  
*premium selection*

- Größen 48-19  
Farben 12  
14  
16  
48  
19  
140  
39  
15

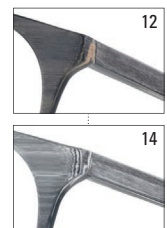

Farbe 16 Zelluloseacetat, Federscharnier

» Look & Feel Herren Metall-, Beflex- und Cellfassungen

LOOK & FEEL **6169**

LOOK & FEEL  
EYEWEAR COLLECTION



- Größen 52-15  
Farben 08  
12  
16  
52  
15  
140  
32  
16

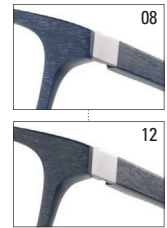

HAND MADE ACETATE  
premium selection

Farbe 16 Zelluloseacetat, Federscharnier

LOOK & FEEL **6168**

LOOK & FEEL  
EYEWEAR COLLECTION



- Größen 57-17  
Farben 08  
12  
16  
57  
17  
140  
38  
19

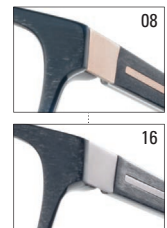

HAND MADE ACETATE  
premium selection

Farbe 12 Zelluloseacetat, Federscharnier

LOOK & FEEL **6167**

LOOK & FEEL  
EYEWEAR COLLECTION



- Größen 56-17  
Farben 12  
14  
16  
56  
17  
140  
37  
17

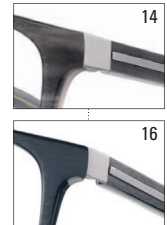

HAND MADE ACETATE  
premium selection

Farbe 12 Zelluloseacetat, Federscharnier

LOOK & FEEL **6166**

LOOK & FEEL  
EYEWEAR COLLECTION



- Größen 53-16  
Farben 08  
12  
16  
53  
16  
140  
36  
12

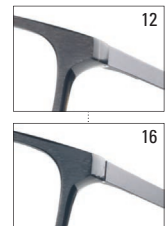

HAND MADE ACETATE  
premium selection

Farbe 08 Zelluloseacetat, Federscharnier, Metallbügel



› Look & Feel Herren Metall-, Beflex- und Cellfassungen

LOOK & FEEL **6165**



LOOK & FEEL  
EYEWEAR COLLECTION

- Größen 57-18  
Farben 08  
12  
14  
57  
18  
140  
38  
19

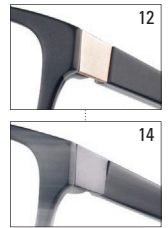

Farbe 08 Zelluloseacetat, Federscharnier

HAND MADE ACETATE  
premium selection

LOOK & FEEL **6164**



LOOK & FEEL  
EYEWEAR COLLECTION

- Größen 49-19  
Farben 11  
12  
16  
49  
19  
140  
39  
19

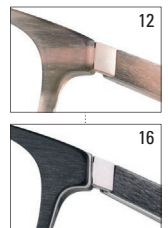

Farbe 11 Zelluloseacetat, Federscharnier

HAND MADE ACETATE  
premium selection

LOOK & FEEL **6163**



LOOK & FEEL  
EYEWEAR COLLECTION

- Größen 58-16  
Farben 12  
14  
16  
58  
16  
145  
38  
18

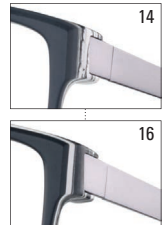

Farbe 12 Zelluloseacetat, Federscharnier, Metallbügel

HAND MADE ACETATE  
premium selection

LOOK & FEEL **6162**



LOOK & FEEL  
EYEWEAR COLLECTION

- Größen 59-18  
Farben 08  
12  
16  
59  
18  
145  
39  
16

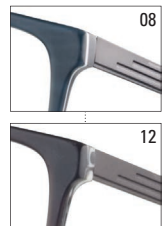

Farbe 16 Zelluloseacetat, Federscharnier, Metallbügel

HAND MADE ACETATE  
premium selection

» Look & Feel Herren Metall-, Beflex- und Cellfassungen

LOOK & FEEL **6161**

LOOK & FEEL  
EYEWEAR COLLECTION



HAND MADE ACETATE  
*premium selection*

- Größen 59-18  
Farben 12  
14  
16  
59  
18  
145  
40  
18

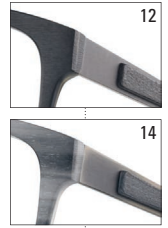

Farbe 16 Zelluloseacetat, Federscharnier, Metallbügel

TOP PREIS LEISTUNG

LOOK & FEEL **6150**

LOOK & FEEL  
EYEWEAR COLLECTION



HAND MADE ACETATE  
*premium selection*

- Größen 58-17  
Farben 08  
12  
16  
58  
17  
145  
38  
18

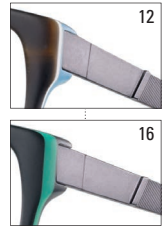

Farbe 08 Zelluloseacetat, Federscharnier, Metallbügel

TOP PREIS LEISTUNG

LOOK & FEEL **6142**

LOOK & FEEL  
EYEWEAR COLLECTION



HAND MADE ACETATE  
*premium selection*

- Größen 59-17  
Farben 12  
14  
59  
17  
143  
35  
17



Farbe 12 Zelluloseacetat, Federscharnier

## Give five.

Binde Optik-Ersatzteilservice für bis zu fünf Jahre, Bügel & Co. für rd. 6.560 Modellvarianten sortiert im Lager: beispiellos!



**Bei Binde Optik ist Service kein Lippenbekenntnis. Für defekte Brillen sind Ersatzteile von einem auf den anderen Tag lieferbar – für Modelle der aktuellen Kollektion und Modelle abgelaufener Kollektionen. Insgesamt für Fassungen aus den letzten fünf Jahren!**

Der typische Fall: Man setzt sich dummerweise auf die Brille, ein Bügel bricht ab, man eilt in düsterer Vorahnung zu einem Optik-Fachgeschäft. Im besten Fall aller Fälle sagt der Händler: „Kein Problem. Das ist unser Großhändler aus Minden. Wenn alles gut läuft, ist das Ersatzteil morgen hier!“ Binde Optik – das bedeutet nicht nur Produktabverkauf, sondern für viele Kunden auch der Inbegriff von Service. Echtem Service! Ist ein Modell ausgelaufen, bietet die Walter Binde GmbH & Co. KG noch bis zu fünf Jahre danach Ersatzteile dafür an. Ersatzteile-Bevorratung, auch für in die Jahre gekommene Fassungen, ist nicht allein ein Aspekt der Reklamation: Binde Optik lebt seit jeher einen hohen Service-Anspruch!

Astrid Barthel, Mitarbeiterin im Innendienst von Binde Optik erzählt: „Ich freue mich, wenn beispielsweise ein Kunde vorsichtig anfragt, ob wir für eine ältere Fassung von uns noch einen rechten Bügel haben. Denn dann kann ich ihn überraschen, indem ich sage: Ja, das ist gar kein Problem!“

Das Team von Binde Optik kennt die Sorgen der Endkunden ganz genau. Es hat den Anspruch, unkompliziert und schnell zu helfen, ein absolut verlässlicher Partner zu sein – ganz gleich, ob Garantie-Leistung

oder eigenes Verschulden. „Alle Ersatzteile, die bis 15.30 Uhr bestellt sind, gehen bei uns per DPD noch am selben Tag raus!“, sagt Astrid Barthel. Neben Verlässlichkeit und Schnelligkeit ist auch die Verfügbarkeit ein wichtiges Kriterium für guten Service. Ob Bügel L/R, Mittelteile/Fronten oder die jeweilige komplette Fassung: das Ersatzteillager bevorratet Ersatzteile für alle Modelle der aktuellen Kollektion und sämtliche Modelle, die innerhalb der letzten fünf Jahre bei Binde Optik in den Kollektionen ausgelaufen sind.

Binde Optik hält aktuell ca. 620 Modelle in der Kollektion, durch unterschiedliche Farben und Größen sind dies ca. 1.200 Varianten, für die Ersatzteile vorrätig sein müssen. Und jährlich kommen im Schnitt rd. 200 neue Fassungen hinzu, auch hier muss die Ersatzteilbevorratung organisiert sein. Insgesamt werden auf rd. 850 lfd. Regalmeter Modellvarianten für 6.560 Ersatzfassungen präzise beschriftet gelagert. Allein bei den Bügeln sind ca. 37.800 auf Lager. All dies erfordert ein besonderes Maß an Übersicht, Sorgfalt und Logistik – und eine immense Kapitalbindung.

Bei jedem neuen Modell wird parallel zum Produktlager im Ersatzteillager für jede Modell-Variante ein separates Lagerfach eingerichtet und mit Ersatzteilen bestückt. Fassungs- und Ersatzteillager werden voneinander unabhängig getrennt geführt. Zwei Mitarbeiterinnen kümmern sich tagtäglich um die permanente Aktualisierung und Kontrolle des Ersatzteilverrats. Das ist Service hoch fünf, high five!

women **8190**

**NEU**

women  
eyewear



**STAINLESS STEEL**  
*premium selection*

Farbe 10 Edelstahl, Federscharnier

- Größen 50-17  
52-17  
Farben 10  
12  
14  
50/52  
17  
130/135  
33/35  
12

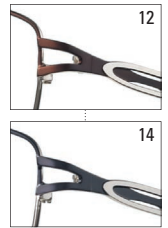

women **8189**

**NEU**

women  
eyewear



**STAINLESS STEEL**  
*premium selection*

Farbe 14 Edelstahl, Federscharnier

- Größen 53-16  
Farben 10  
12  
14  
53  
16  
135  
34  
13

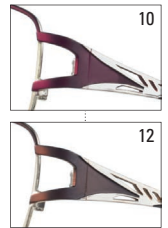

women **8188**

**NEU**

women  
eyewear



**STAINLESS STEEL**  
*premium selection*

Farbe 12 Edelstahl, Federscharnier, Kunststoffbügel

- Größen 54-16  
Farben 10  
12  
15  
54  
16  
135  
36  
15

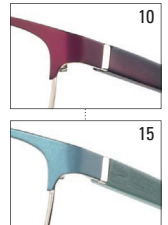

women **8187**

**NEU**

women  
eyewear



**STAINLESS STEEL**  
*premium selection*

Farbe 12 Edelstahl, Federscharnier, Kunststoffbügel

- Größen 53-16  
Farben 10  
12  
14  
53  
16  
135  
37  
14

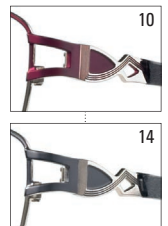



women **8186**

**NEU**

women  
eyewear



STAINLESS STEEL  
*premium selection*

Farbe 10 Edelstahl, Federscharnier, Kunststoffbügel

- Größen 49-17  
51-17  
Farben 10  
12  
15  
15  
49/51  
17  
130/135  
33/35  
14

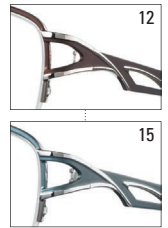

women **8152**

women  
eyewear



STAINLESS STEEL  
*premium selection*

Farbe 10 Edelstahl, Federscharnier

- Größen 50-17  
52-17  
Farben 10  
12  
14  
14  
50/52  
17  
130/135  
34/35  
14

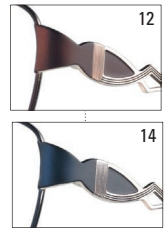

women **8151**

women  
eyewear



STAINLESS STEEL  
*premium selection*

Farbe 14 Edelstahl, Federscharnier, Kunststoffbügel

- Größen 53-18  
Farben 10  
12  
14  
14  
53  
18  
135  
34  
18

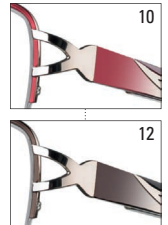

women **8150**

women  
eyewear



STAINLESS STEEL  
*premium selection*

Farbe 12 Edelstahl, Federscharnier

- Größen 53-16  
Farben 12  
15  
17  
17  
53  
16  
135  
36  
14

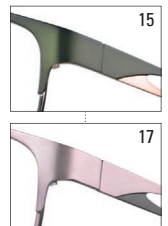



› women Damen Metallfassungen

women **8149**

women  
eyewear



STAINLESS STEEL  
premium selection

- Größen 54-16  
Farben 10  
12  
17  
54  
16  
135  
35  
15

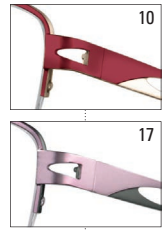

Farbe 12 Edelstahl, Federscharnier

women **8148**

women  
eyewear



STAINLESS STEEL  
premium selection

- Größen 53-16  
Farben 02  
12  
17  
53  
16  
135  
37  
18

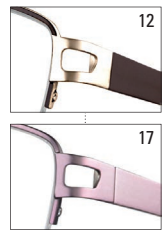

Farbe 02 Edelstahl, Federscharnier

women **8106**

women  
eyewear



STAINLESS STEEL  
premium selection

- Größen 48-17  
Farben 10  
12  
17  
48  
17  
130  
32  
15

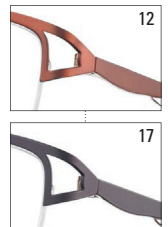

Farbe 10 Edelstahl, Federscharnier

women **8102**

women  
eyewear



STAINLESS STEEL  
premium selection

- Größen 55-15  
Farben 10  
12  
14  
55  
15  
135  
36  
14

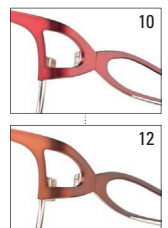

Farbe 14 Edelstahl

women **8063**

women  
eyewear



STAINLESS STEEL  
*premium selection*

Farbe 14 Edelstahl, Federscharnier, Kunststoffbügel

- Größen 53-17  
Farben 10  
12  
14  
53  
17  
135  
32  
16



women **8050**

women  
eyewear



STAINLESS STEEL  
*premium selection*

Farbe 12 Edelstahl, Federscharnier, Kunststoffbügel

- Größen 51-18  
Farben 12  
17  
51  
18  
135  
32  
16



women **8049**

women  
eyewear



STAINLESS STEEL  
*premium selection*

Farbe 14 Edelstahl, Federscharnier

- Größen 53-18  
Farben 10  
14  
15  
53  
18  
135  
33  
13

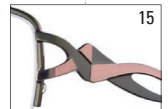

women **8034**

women  
eyewear



STAINLESS STEEL  
*premium selection*

Farbe 08 Edelstahl, Federscharnier

- Größen 50-17  
Farben 08  
10  
12  
50  
17  
135  
32  
11



› women Damen Metallfassungen

women **8033**

women  
eyewear



- Größen 48-17  
 Farben 10  
 12  
 17  
 48  
 17  
 135  
 31  
 12

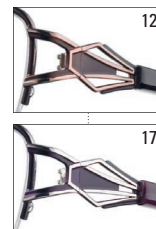

Farbe 10 Edelstahl, Federscharnier

STAINLESS STEEL  
premium selection

› men Herren Metall-, Beflex- und Cellfassungen

men **7925**

**NEU**

men  
eyewear



- Größen 54-18  
 56-18  
 Farben 02  
 14  
 54/56  
 18  
 140  
 37/38  
 18



Farbe 14 Edelstahl, Federscharnier, Kunststoffbügel

STAINLESS STEEL  
premium selection

men **7924**

**NEU**

men  
eyewear



- Größen 56-17  
 58-17  
 Farben 02  
 14  
 56/58  
 17  
 140/145  
 37/39  
 15



Farbe 02 Edelstahl, Federscharnier, Kunststoffbügel

STAINLESS STEEL  
premium selection

men **7884**



men  
eyewear

- Größen 55-19  
Farben 02  
14  
16  
55  
19  
140  
38  
17

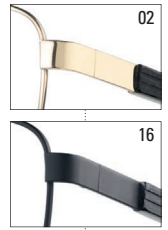

Farbe 14 Edelstahl, Federscharnier, Kunststoffbügel, BEFLEX Memorybrücke

men **7862**



men  
eyewear

- Größen 54-19  
56-19  
Farben 02  
12  
14  
54/56  
19  
140  
36/38  
17

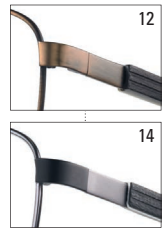

Farbe 02 Edelstahl, Federscharnier, Kunststoffbügel

men **7861**



men  
eyewear

- Größen 53-18  
55-18  
Farben 02  
14  
16  
53/55  
18  
140  
36/38  
18

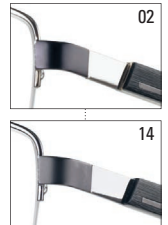

Farbe 16 Edelstahl, Federscharnier, Kunststoffbügel

men **7860**



men  
eyewear

- Größen 54-19  
56-19  
Farben 02  
14  
16  
54/56  
19  
140  
34/36  
15

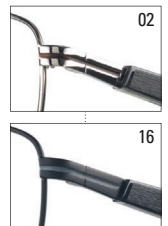

Farbe 14 Edelstahl, Federscharnier, Kunststoffbügel

men **7798**

men  
eyewear



STAINLESS STEEL  
premium selection

- Größen 58-17  
60-17
- Farben 12  
14
- ⊖ 58/60
  - ⊗ 17
  - ⌒ 140/145
  - Ⓢ 38/40
  - Ⓜ 19



12

Farbe 14 Edelstahl, Federscharnier

men **7788**

men  
eyewear



STAINLESS STEEL  
premium selection

- Größen 50-17  
52-17
- Farben 02  
14
- ⊖ 50/52
  - ⊗ 17
  - ⌒ 135/140
  - Ⓢ 33/34
  - Ⓜ 10



02

Farbe 14 Edelstahl, Federscharnier

men **7759**

men  
eyewear



STAINLESS STEEL  
premium selection

- Größen 57-18  
59-18
- Farben 01  
02
- ⊖ 57/59
  - ⊗ 18
  - ⌒ 140
  - Ⓢ 34/36
  - Ⓜ 17



01

Farbe 02 Edelstahl, Federscharnier, Kunststoffbügel

men **7753**

men  
eyewear



STAINLESS STEEL  
premium selection

- Größen 54-18  
56-18
- Farben 02  
14
- ⊖ 54/56
  - ⊗ 18
  - ⌒ 140
  - Ⓢ 34/36
  - Ⓜ 14



14

Farbe 02 Edelstahl, Federscharnier, Kunststoffbügel



men **7752**

men  
eyewear



STAINLESS STEEL  
*premium selection*

- Größen 53-19  
55-19  
Farben 02  
14  
53/55  
19  
140  
34/36  
13



14

Farbe 02 Edelstahl, Federscharnier, Kunststoffbügel

men **7746**

men  
eyewear



- Größen 55-19  
57-19  
Farben 02  
14  
55/57  
19  
140/145  
35/37  
18



14

Farbe 02 Federscharnier

men **6129**

men  
eyewear



HAND MADE ACETATE  
*premium selection*

- Größen 58-18  
60-18  
Farben 12  
16  
58/60  
18  
145  
37/38  
24



12

Farbe 16 Zelluloseacetat, Federscharnier

Jump Up 2896



**JUMP UP**  
DIE BRILLE

Größen 49-17

Farben 08

10

16

⊖

⊕

⊖

⊕

⊖

⊕

14



08



10

**STAINLESS STEEL**  
*premium selection*

Farbe 16 Edelstahl, Federscharnier

Jump Up 2895



**JUMP UP**  
DIE BRILLE

Größen 50-16

Farben 08

10

16

⊖

⊕

⊖

⊕

⊖

⊕

14



08



16

**STAINLESS STEEL**  
*premium selection*

Farbe 10 Edelstahl, Federscharnier

Jump Up 2894



**JUMP UP**  
DIE BRILLE

Größen 52-17

Farben 10

14

16

⊖

⊕

⊖

⊕

⊖

⊕

19



10



14

**STAINLESS STEEL**  
*premium selection*

Farbe 16 Edelstahl, Federscharnier

Jump Up 2891



**JUMP UP**  
DIE BRILLE

Größen 51-17

Farben 08

14

16

⊖

⊕

⊖

⊕

⊖

⊕

18



14



16

**STAINLESS STEEL**  
*premium selection*

Farbe 08 Edelstahl, Federscharnier, Kunststoffbügel

Jump Up 2887



**JUMP UP**  
DIE BRILLE

- Größen 50-16  
 Farben 10  
 12  
 17  
 50  
 16  
 130  
 34  
 15

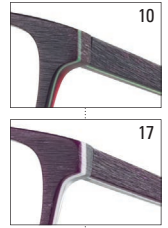

HAND MADE ACETATE  
premium selection

Farbe 12 Zelluloseacetat, Federscharnier

Jump Up 2884



**JUMP UP**  
DIE BRILLE

- Größen 50-16  
 Farben 08  
 14  
 16  
 50  
 16  
 135  
 32  
 17

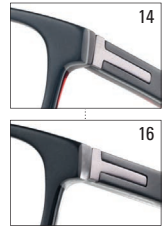

HAND MADE ACETATE  
premium selection

Farbe 08 Zelluloseacetat, Federscharnier

TOP PREIS LEISTUNG

Jump Up 2881



**JUMP UP**  
DIE BRILLE

- Größen 48-16  
 Farben 08  
 10  
 14  
 15  
 48  
 16  
 135  
 28  
 14

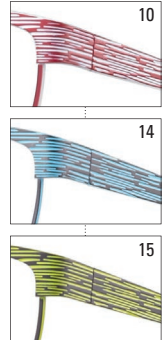

STAINLESS STEEL  
premium selection

Farbe 08 Edelstahl, Federscharnier

Jump Up 2880



**JUMP UP**  
DIE BRILLE

- Größen 48-16  
 Farben 08  
 14  
 16  
 48  
 16  
 135  
 29  
 16

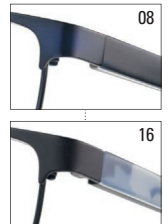

STAINLESS STEEL  
premium selection

Farbe 14 Edelstahl, Federscharnier, Kunststoffbügel

Jump Up Teens **2903**



**STAINLESS STEEL**  
*premium selection*

- Größen 49-17  
Farben 08  
12  
16  
49  
17  
135  
30  
12

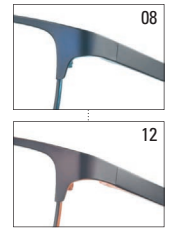

Farbe 16 Edelstahl, Federscharnier

Jump Up Teens **2902**



**STAINLESS STEEL**  
*premium selection*

- Größen 48-17  
Farben 10  
16  
17  
48  
17  
130  
32  
12

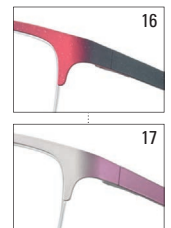

Farbe 10 Edelstahl, Federscharnier

Jump Up Teens **2901**



**XTRA LIGHT ACETATE**  
*premium selection*

- Größen 51-16  
Farben 08  
14  
16  
51  
16  
135  
33  
13

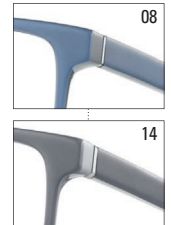

Farbe 16 Zelluloseacetat, Federscharnier

Jump Up Teens **2900**



**XTRA LIGHT ACETATE**  
*premium selection*

- Größen 49-17  
Farben 10  
16  
17  
49  
17  
135  
33  
13

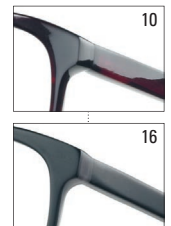

Farbe 17 Zelluloseacetat, Federscharnier

Jump Up Teens **2899**



**JUMP UP**  
TEENS

- Größen 51-16  
 Farben 08  
 14  
 16  
 51  
 16  
 135  
 32  
 16

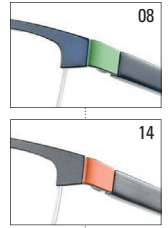

**STAINLESS STEEL**  
*premium selection*

Farbe 16 Edelstahl, Federscharnier, Kunststoffbügel

Jump Up Teens **2897**



**JUMP UP**  
TEENS

- Größen 51-17  
 Farben 08  
 14  
 16  
 51  
 17  
 135  
 30  
 14

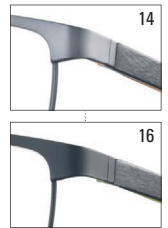

**STAINLESS STEEL**  
*premium selection*

Farbe 08 Edelstahl, Federscharnier, Kunststoffbügel

Jump Up Teens **2889**



**JUMP UP**  
TEENS

- Größen 49-18  
 Farben 08  
 14  
 16  
 49  
 18  
 135  
 30  
 16

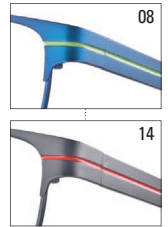

**STAINLESS STEEL**  
*premium selection*

Farbe 16 Edelstahl, Federscharnier

Jump Up Teens **2888**



**JUMP UP**  
TEENS

- Größen 49-16  
 Farben 10  
 12  
 16  
 49  
 16  
 130  
 34  
 13

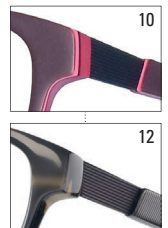

**HAND MADE ACETATE**  
*premium selection*

Farbe 16 Zelluloseacetat, Federscharnier



Jump Up Teens **2877**

**JUMP UP**  
TEENS



**STAINLESS STEEL**  
*premium selection*

Farbe 12    Edelstahl, Federscharnier, Kunststoffbügel

- Größen 50-16  
Farben 08  
12  
14  
50  
16  
135  
31  
19

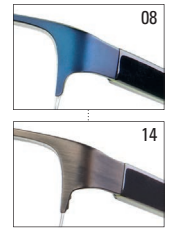

» **WICHTIGE SERVICE-INFORMATIONEN** zum OBE-Federscharnier (flexUno)

**Modellreihe flexUno 2.7:** BI 4271, BI 4272, BI 4273, BI 4277, BI 4278, BI 4279, BI 4280

**Modellreihe flexUno 3.0:** BI 4266, BI 4267, BI 4268, BI 4269, BI 4270

» Ersatzteile auf Seite 97

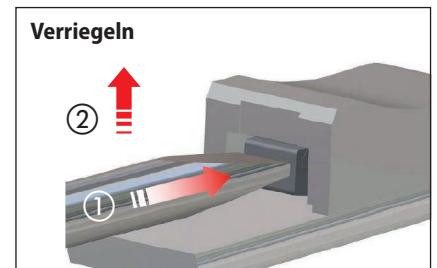
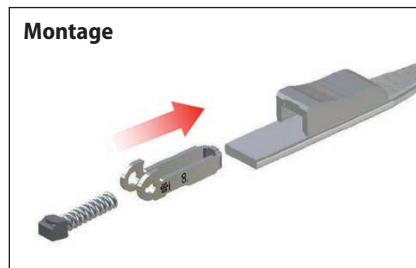
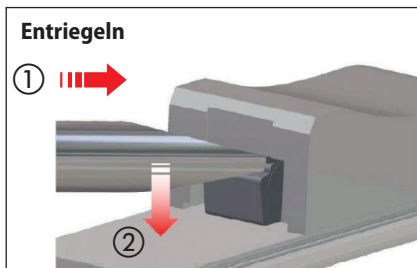

Kids One **4280**

**NEU**

**KID'S ONE**



**HAND MADE ACETATE**  
*premium selection*

Farbe 10    Zelluloseacetat, OBE-Federscharnier

- Größen 45-14  
47-14  
Farben 10  
16  
17  
45/47  
14  
125/130  
28/29  
15

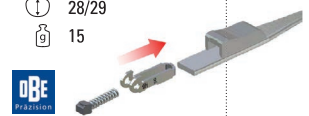
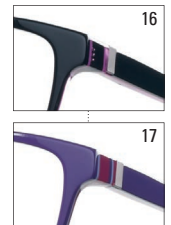

Kids One **4279**

**NEU**

**KID'S ONE**



**STAINLESS STEEL**  
*premium selection*

Farbe 17    Edelstahl, OBE-Federscharnier, Kunststoffbügel

- Größen 45-16  
47-16  
Farben 07  
10  
17  
45/47  
16  
125/130  
29/30  
15

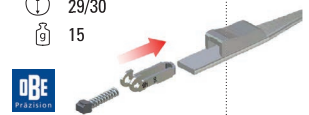
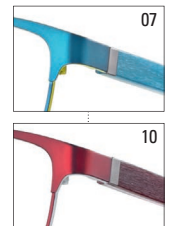

Kids One **4278**

**NEU**

KID'S ONE®



**STAINLESS STEEL**  
premium selection

- Größen 46-18  
48-18  
Farben 08  
09  
16  
46/48  
18  
125/130  
28/29  
15

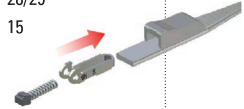
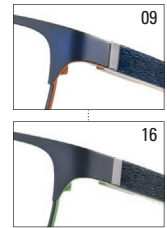

Farbe 08 Edelstahl, OBE-Federscharnier, Kunststoffbügel

Kids One **4277**

KID'S ONE®



**STAINLESS STEEL**  
premium selection

- Größen 42-16  
44-16  
Farben 08  
10  
16  
42/44  
16  
120/125  
33/35  
16

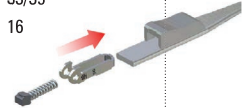
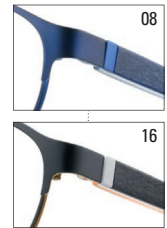

Farbe 10 Edelstahl, OBE-Federscharnier, Kunststoffbügel

Kids One **4273**

KID'S ONE®



**HAND MADE ACETATE**  
premium selection

- Größen 42-15  
44-15  
Farben 10  
16  
17  
42/44  
15  
115/120  
33/34  
15

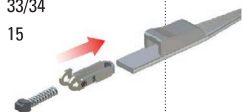
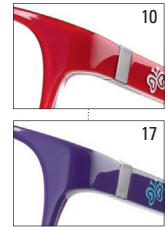

Farbe 16 Zelluloseacetat, OBE-Federscharnier

Kids One **4272**

KID'S ONE®



**HAND MADE ACETATE**  
premium selection

- Größen 44-15  
46-15  
Farben 08  
10  
16  
44/46  
15  
120/125  
28/29  
14

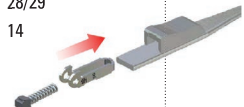
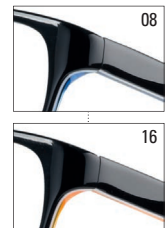

Farbe 10 Zelluloseacetat, OBE-Federscharnier

Kids One **4271**



HAND MADE ACETATE  
*premium selection*

Farbe 08 Zelluloseacetat, OBE-Federscharnier

Größen 45-16  
47-16  
Farben 07  
08  
16  
45/47  
16  
125/130  
28/29  
15

OBE Präzision

Kids One **4270**



STAINLESS STEEL  
*premium selection*

Farbe 08 Edelstahl, OBE-Federscharnier

Größen 44-17  
46-17  
Farben 08  
14  
15  
44/46  
17  
120/125  
28/29  
14

OBE Präzision

Kids One **4269**



STAINLESS STEEL  
*premium selection*

Farbe 07 Edelstahl, OBE-Federscharnier

Größen 45-16  
47-16  
Farben 07  
12  
17  
45/47  
16  
120/125  
27/29  
14

OBE Präzision

Kids One **4268**



STAINLESS STEEL  
*premium selection*

Farbe 16 Edelstahl, OBE-Federscharnier

Größen 45-17  
47-17  
Farben 07  
08  
16  
45/47  
17  
120/125  
27/28  
15

OBE Präzision

Kids One 4267



**STAINLESS STEEL**  
*premium selection*

Farbe 10 Edelstahl, OBE-Federscharnier

|        |         |  |    |
|--------|---------|--|----|
| Größen | 43-15   |  | 05 |
|        | 45-15   |  |    |
| Farben | 05      |  | 17 |
|        | 10      |  |    |
|        | 17      |  |    |
|        | 43/45   |  |    |
|        | 15      |  |    |
|        | 120/125 |  |    |
|        | 26/27   |  |    |
|        | 14      |  |    |

Kids One 4266



**STAINLESS STEEL**  
*premium selection*

Farbe 17 Edelstahl, OBE-Federscharnier

|        |         |  |    |
|--------|---------|--|----|
| Größen | 44-16   |  | 10 |
|        | 46-16   |  |    |
| Farben | 10      |  | 15 |
|        | 15      |  |    |
|        | 17      |  |    |
|        | 44/46   |  |    |
|        | 16      |  |    |
|        | 120/125 |  |    |
|        | 28/30   |  |    |
|        | 14      |  |    |

TOP PREIS LEISTUNG

Kids One 4257



**STAINLESS STEEL**  
*premium selection*

Farbe 15 Edelstahl, Federscharnier

|        |         |  |    |
|--------|---------|--|----|
| Größen | 44-16   |  | 08 |
|        | 46-16   |  |    |
| Farben | 08      |  | 10 |
|        | 10      |  |    |
|        | 14      |  |    |
|        | 15      |  |    |
|        | 44/46   |  |    |
|        | 16      |  |    |
|        | 125/130 |  |    |
|        | 25/26   |  |    |
|        | 14      |  |    |

TOP PREIS LEISTUNG

Kids One 4251



**HAND MADE ACETATE**  
*premium selection*

Farbe 17 Zelluloseacetat, Federscharnier

|        |         |  |    |
|--------|---------|--|----|
| Größen | 43-16   |  | 08 |
|        | 45-16   |  |    |
| Farben | 08      |  | 10 |
|        | 10      |  |    |
|        | 17      |  |    |
|        | 43/45   |  |    |
|        | 16      |  |    |
|        | 120/125 |  |    |
|        | 27      |  |    |
|        | 15      |  |    |

Skylight **540**



**SKYLIGHT**  
TITANIUM EYEWEAR

- Größen 52-17  
 Farben 10  
 14  
 52  
 17  
 135  
 35  
 8



Farbe 10 Beta Titan, Federscharnier

**BETA-TITANIUM**  
*Nickel Allergy Free*

Skylight **539**



**SKYLIGHT**  
TITANIUM EYEWEAR

- Größen 55-18  
 Farben 12  
 14  
 16  
 55  
 18  
 140  
 36  
 10



Farbe 16 Beta Titan, Federscharnier

**BETA-TITANIUM**  
*Nickel Allergy Free*



Skylight **536**



**SKYLIGHT**  
TITANIUM EYEWEAR

- Größen 52-17  
 Farben 12  
 16  
 17  
 52  
 17  
 135  
 33  
 13



Farbe 17 Beta Titan, Federscharnier

**BETA-TITANIUM**  
*Nickel Allergy Free*



Skylight **535**



**SKYLIGHT**  
TITANIUM EYEWEAR

- Größen 52-16  
 Farben 08  
 10  
 16  
 52  
 16  
 135  
 34  
 12



Farbe 08 Beta Titan, Federscharnier

**BETA-TITANIUM**  
*Nickel Allergy Free*

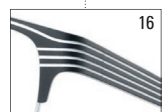



Skylight **534**



**SKYLIGHT**  
TITANIUM EYEWEAR

**BETA-TITANIUM**  
*Nickel Allergy Free*

- Größen 54-15  
 Farben 12  
 14  
 54  
 15  
 135  
 34  
 9



12

Farbe 14 Beta Titan, Federscharnier

Skylight **533**



**SKYLIGHT**  
TITANIUM EYEWEAR

**BETA-TITANIUM**  
*Nickel Allergy Free*

- Größen 51-17  
 Farben 10  
 14  
 51  
 17  
 135  
 34  
 12



14

Farbe 10 Beta Titan, Federscharnier

Skylight **532**



**SKYLIGHT**  
TITANIUM EYEWEAR

**BETA-TITANIUM**  
*Nickel Allergy Free*

- Größen 49-17  
 Farben 08  
 16  
 49  
 17  
 130  
 33  
 10



08

Farbe 16 Beta Titan, Federscharnier

Skylight **531**



**SKYLIGHT**  
TITANIUM EYEWEAR

**BETA-TITANIUM**  
*Nickel Allergy Free*

- Größen 56-19  
 Farben 02  
 14  
 56  
 19  
 140  
 36  
 13



02

Farbe 14 Beta Titan, Federscharnier

# Skylight Titan

## Skylight 530



**SKYLIGHT**  
TITANIUM EYEWEAR

**BETA-TITANIUM**  
*Nickel Allergy Free*

- Größen 56-19  
Farben 02  
14  
56  
19  
140  
36  
12



14

Farbe 02 Beta Titan, Federscharnier

## Skylight 529



**SKYLIGHT**  
TITANIUM EYEWEAR

**BETA-TITANIUM**  
*Nickel Allergy Free*

- Größen 55-18  
Farben 02  
14  
55  
18  
140  
36  
13



14

Farbe 02 Beta Titan, Federscharnier

## Skylight 528



**SKYLIGHT**  
TITANIUM EYEWEAR

**BETA-TITANIUM**  
*Nickel Allergy Free*

- Größen 54-19  
Farben 02  
14  
54  
19  
140  
35  
11



02

Farbe 14 Beta Titan, Federscharnier

## Skylight 526



**SKYLIGHT**  
TITANIUM EYEWEAR

**BETA-TITANIUM**  
*Nickel Allergy Free*

- Größen 58-18  
Farben 12  
14  
58  
18  
145  
36  
13



14

Farbe 12 Beta Titan, Federscharnier

Skylight 524



SKYLIGHT  
TITANIUM EYEWEAR

BETA-TITANIUM  
*Nickel Allergy Free*

- Größen 53-17  
Farben 12  
16  
17  
53  
17  
135  
37  
15

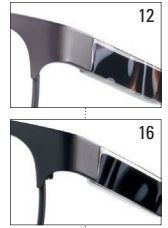

Farbe 17 Beta Titan, Federscharnier, Kunststoffbügel

Skylight 523



SKYLIGHT  
TITANIUM EYEWEAR

BETA-TITANIUM  
*Nickel Allergy Free*

- Größen 53-18  
Farben 08  
14  
16  
53  
18  
140  
32  
15

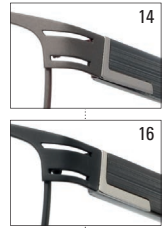

Farbe 08 Beta Titan, Federscharnier, Kunststoffbügel

Skylight 521



SKYLIGHT  
TITANIUM EYEWEAR

BETA-TITANIUM  
*Nickel Allergy Free*

- Größen 54-18  
Farben 08  
16  
54  
18  
140  
33  
12



Farbe 16 Beta Titan, Federscharnier

Skylight 520



SKYLIGHT  
TITANIUM EYEWEAR

BETA-TITANIUM  
*Nickel Allergy Free*

- Größen 57-18  
Farben 08  
12  
14  
57  
18  
140  
36  
19

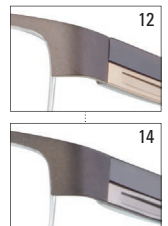

Farbe 08 Beta Titan, Federscharnier, Kunststoffbügel

Skylight 519



SKYLIGHT  
TITANIUM EYEWEAR

- Größen 56-18  
Farben 08  
12  
14  
56  
18  
140  
34  
12

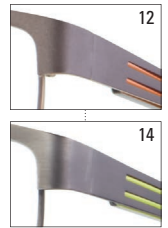

Farbe 08 Beta Titan, Federscharnier

BETA-TITANIUM  
Nickel Allergy Free

TOPPREMIUMLEISTUNG

Skylight 515



SKYLIGHT  
TITANIUM EYEWEAR

- Größen 50-18  
Farben 12  
16  
50  
18  
135  
33  
17



Farbe 16 Beta Titan, Federscharnier, Kunststoffbügel

BETA-TITANIUM  
Nickel Allergy Free

Skylight 512



SKYLIGHT  
TITANIUM EYEWEAR

- Größen 51-18  
53-18  
Farben 12  
14  
51/53  
18  
140  
33/34  
9



Farbe 14 Beta Titan, Federscharnier

BETA-TITANIUM  
Nickel Allergy Free

Skylight 511



SKYLIGHT  
TITANIUM EYEWEAR

- Größen 50-18  
52-18  
Farben 02  
12  
50/52  
18  
140  
34/34  
9



Farbe 02 Beta Titan, Federscharnier

BETA-TITANIUM  
Nickel Allergy Free

TOP PREIS LEISTUNG

Skylight **599**

**SKYLIGHT**  
TITANIUM EYEWEAR



**BETA-TITANIUM**  
*Nickel Allergy Free*

Farbe 16    Beta Titan, Federscharnier

Größen 55-18

Farben 08

14

16

⊖

⊕

⌒

⌒

⌒

⌒

⌒

⌒

⌒

⌒

⌒

⌒

⌒

⌒

⌒

⌒

⌒

⌒

⌒

⌒

⌒

⌒

⌒

⌒

⌒

⌒

⌒

⌒

⌒

⌒

⌒

⌒

⌒

⌒

⌒

⌒

⌒

⌒

⌒

⌒

⌒

⌒

⌒

⌒

⌒

⌒

⌒

⌒

⌒

⌒

⌒

⌒

⌒

⌒

⌒

⌒

⌒

⌒

⌒

⌒

⌒

⌒

⌒

⌒





readers **1181**

**NEU**



**XTRA LIGHT ACETATE**  
*premium selection*

Farbe 16 Zelluloseacetat, Federscharnier

- Größen 52-20  
Farben 08  
12  
16  
52  
20  
145  
23  
12

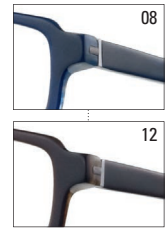

readers **1180**

**NEU**



**STAINLESS STEEL**  
*premium selection*

Farbe 10 Edelstahl, Federscharnier, Kunststoffbügel

- Größen 49-20  
Farben 10  
12  
15  
16  
49  
20  
145  
23  
15

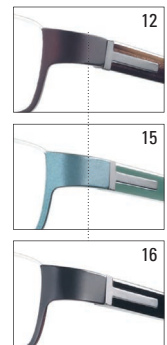

readers **1179**

**NEU**



**HAND MADE ACETATE**  
*premium selection*

Farbe 08 Zelluloseacetat, Federscharnier

- Größen 51-21  
Farben 08  
10  
16  
51  
21  
145  
24  
16

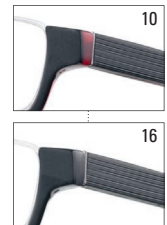

readers **1178**

**NEU**



**STAINLESS STEEL**  
*premium selection*

Farbe 12 Edelstahl, Federscharnier, Kunststoffbügel

- Größen 49-20  
Farben 10  
12  
16  
49  
20  
145  
23  
13

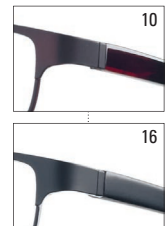

readers 1177

**NEU**



**STAINLESS STEEL**  
*premium selection*

Farbe 16 Edelstahl, Federscharnier

- Größen 50-20  
Farben 10  
12  
16  
50  
20  
145  
23  
14

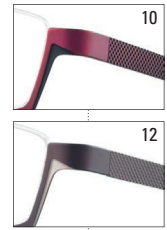

readers 1176

**NEU**



**STAINLESS STEEL**  
*premium selection*

Farbe 16 Edelstahl, Federscharnier, Kunststoffbügel

- Größen 49-20  
Farben 10  
12  
16  
49  
20  
145  
23  
14

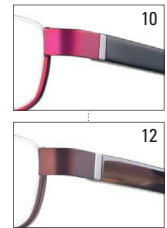

readers 1175

**NEU**



**STAINLESS STEEL**  
*premium selection*

Farbe 16 Edelstahl, Federscharnier

- Größen 50-19  
Farben 10  
12  
16  
50  
19  
145  
24  
15

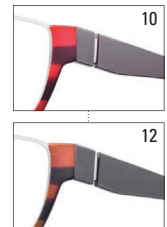

readers 1174

**NEU**



**STAINLESS STEEL**  
*premium selection*

Farbe 12 Edelstahl, Federscharnier

- Größen 49-19  
Farben 08  
12  
16  
49  
19  
145  
24  
11

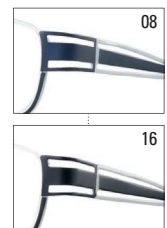

readers **1173**

**NEU**



**STAINLESS STEEL**  
*premium selection*

Farbe 10 Edelstahl, Federscharnier, Kunststoffbügel

- Größen 48-21  
Farben 10  
12  
15  
48  
21  
145  
23  
14

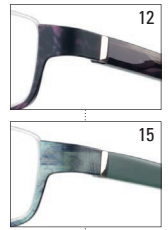

readers **1170**



**STAINLESS STEEL**  
*premium selection*

Farbe 16 Edelstahl, Federscharnier, Kunststoffbügel

- Größen 51-22  
Farben 12  
14  
16  
51  
22  
145  
23  
17

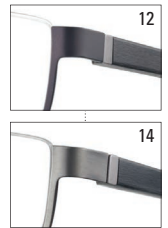

readers **1169**



**STAINLESS STEEL**  
*premium selection*

Farbe 08 Edelstahl, Federscharnier, Kunststoffbügel

- Größen 51-22  
Farben 08  
14  
16  
51  
22  
145  
26  
18

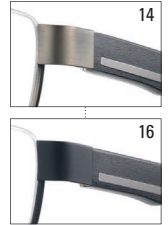

readers **1168**



**BEFLEX**  
STAINLESS STEEL

Farbe 16 Edelstahl, Federscharnier, Kunststoffbügel, BEFLEX Memorybrücke

- Größen 52-22  
Farben 12  
14  
16  
52  
22  
145  
26  
14

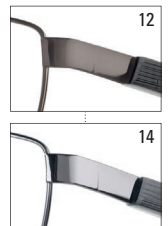

readers **1167**



HAND MADE ACETATE  
premium selection

Größen 52-18

Farben 01

12

14

16

52

18

145

26

14



01



14



16

Farbe 12 Zelluloseacetat, Federscharnier, Metallbügel

readers **1165**



BEFLEX  
STAINLESS STEEL

Größen 53-21

Farben 12

14

16

53

21

145

24

18



12



14

Farbe 16 Edelstahl, Federscharnier, Kunststoffbügel, BEFLEX Memorybrücke

readers **1164**



BEFLEX  
STAINLESS STEEL

Größen 52-23

Farben 12

14

16

52

23

145

26

21



12



16

Farbe 14 Edelstahl, Federscharnier, Kunststoffbügel, BEFLEX Memorybrücke

readers **1163**



STAINLESS STEEL  
premium selection

Größen 51-22

Farben 12

14

16

51

22

145

24

15



12



16

Farbe 14 Edelstahl, Federscharnier

readers **1162**



**STAINLESS STEEL**  
*premium selection*

- Größen 52-21  
Farben 12  
14  
16  
52  
21  
145  
26  
18

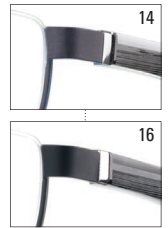

Farbe 12 Edelstahl, Federscharnier, Kunststoffbügel

readers **1155**



**STAINLESS STEEL**  
*premium selection*

- Größen 52-22  
Farben 08  
12  
16  
52  
22  
145  
26  
19

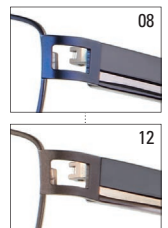

Farbe 16 Edelstahl, Federscharnier, Kunststoffbügel

readers **1147**



**STAINLESS STEEL**  
*premium selection*

- Größen 52-21  
Farben 12  
14  
16  
52  
21  
145  
26  
19

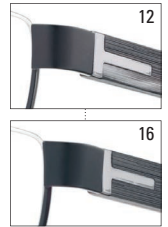

Farbe 14 Edelstahl, Federscharnier, Kunststoffbügel

readers **1143**



**STAINLESS STEEL**  
*premium selection*

- Größen 51-20  
Farben 12  
14  
16  
51  
20  
145  
22  
20

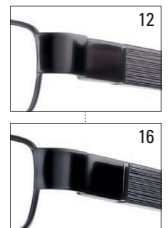

Farbe 14 Edelstahl, Federscharnier, Kunststoffbügel, Vollsteg



readers **1139**



**STAINLESS STEEL**  
*premium selection*

Größen 51-22  
53-22

Farben 01  
02  
51/53  
22  
145  
25/26  
13



Farbe 02 Edelstahl, Federscharnier, Kunststoffbügel

TOP PREIS LEISTUNG

Start Up Premium **8201**

**NEU**

**STARTUP**  
premium



STAINLESS STEEL  
premium selection

Farbe 08 Edelstahl, Federscharnier

- Größen 52-17  
Farben 08  
12  
16  
52  
17  
135  
37  
14

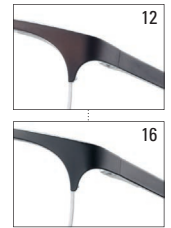

TOP PREIS LEISTUNG

Start Up Premium **8200**

**NEU**

**STARTUP**  
premium



STAINLESS STEEL  
premium selection

Farbe 12 Edelstahl, Federscharnier

- Größen 53-16  
Farben 10  
12  
16  
53  
16  
135  
37  
14

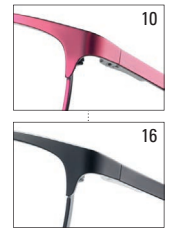

TOP PREIS LEISTUNG

Start Up Premium **8199**

**NEU**

**STARTUP**  
premium



STAINLESS STEEL  
premium selection

Farbe 10 Edelstahl, Federscharnier, Kunststoffbügel

- Größen 54-16  
Farben 10  
12  
16  
54  
16  
135  
37  
18

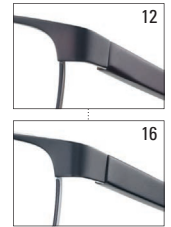

TOP PREIS LEISTUNG

Start Up Premium **8183**

**STARTUP**  
premium



STAINLESS STEEL  
premium selection

Farbe 16 Edelstahl, Federscharnier

- Größen 53-16  
Farben 08  
10  
16  
53  
16  
135  
35  
14

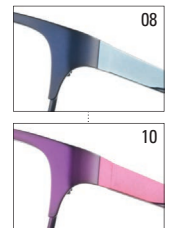

TOP PREIS LEISTUNG

Start Up Premium **8182**

**STARTUP**  
premium



STAINLESS STEEL  
premium selection

Farbe 12 Edelstahl, Federscharnier, Kunststoffbügel

- Größen 52-17  
Farben 10  
12  
16  
52  
17  
135  
33  
18

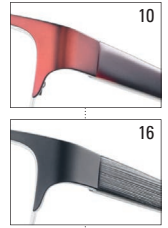

TOP PREIS LEISTUNG

Start Up Premium **8166**

**STARTUP**  
premium



STAINLESS STEEL  
premium selection

Farbe 14 Edelstahl, Federscharnier, Kunststoffbügel

- Größen 53-17  
Farben 12  
14  
17  
53  
17  
135  
35  
20

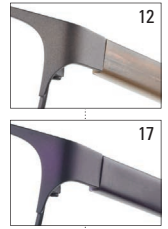

TOP PREIS LEISTUNG

Start Up Premium **8165**

**STARTUP**  
premium



STAINLESS STEEL  
premium selection

Farbe 16 Edelstahl, Federscharnier

- Größen 52-16  
Farben 12  
16  
17  
52  
16  
135  
33  
16

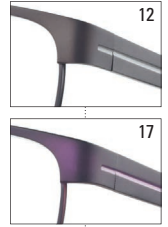

TOP PREIS LEISTUNG

Start Up Premium **8163**

**STARTUP**  
premium



STAINLESS STEEL  
premium selection

Farbe 10 Edelstahl, Federscharnier

- Größen 52-16  
Farben 08  
10  
16  
52  
16  
140  
35  
16

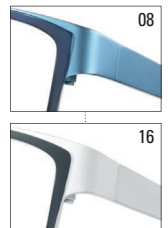

Start Up Premium

TOP PREIS LEISTUNG

Start Up Premium 8162

STARTUP premium



- Größen 52-19  
 Farben 08  
 14  
 17  
 52  
 19  
 138  
 35  
 18

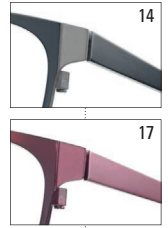

Farbe 08 Edelstahl, Federscharnier

STAINLESS STEEL  
 premium selection

TOP PREIS LEISTUNG

Start Up Premium 8120

STARTUP premium



- Größen 51-18  
 Farben 08  
 12  
 16  
 51  
 18  
 140  
 33  
 20

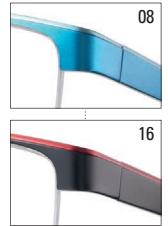

Farbe 12 Edelstahl, Federscharnier

STAINLESS STEEL  
 premium selection

TOP PREIS LEISTUNG

Start Up Premium 8116

STARTUP premium



- Größen 50-18  
 Farben 12  
 16  
 50  
 18  
 135  
 34  
 21

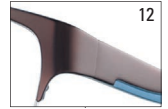

Farbe 16 Edelstahl, Federscharnier

STAINLESS STEEL  
 premium selection

TOP PREIS LEISTUNG

Start Up Premium 8115

STARTUP premium



- Größen 55-17  
 Farben 10  
 12  
 16  
 55  
 17  
 135  
 32  
 20

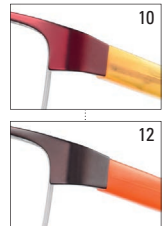

Farbe 16 Edelstahl, Federscharnier, Kunststoffbügel

STAINLESS STEEL  
 premium selection

TOP PREIS LEISTUNG

Start Up Premium **8113**

**STARTUP**  
premium



STAINLESS STEEL  
premium selection

Farbe 10 Edelstahl, Federscharnier, Kunststoffbügel

- Größen 54-16  
Farben 10  
12  
16  
54  
16  
135  
35  
19

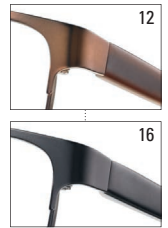

TOP PREIS LEISTUNG

Start Up Premium **7930**

**NEU**

**STARTUP**  
premium



STAINLESS STEEL  
premium selection

Farbe 08 Edelstahl, Federscharnier, Kunststoffbügel

- Größen 51-17  
Farben 08  
14  
16  
51  
17  
140  
28  
17

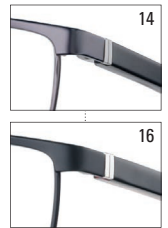

TOP PREIS LEISTUNG

Start Up Premium **7929**

**NEU**

**STARTUP**  
premium



STAINLESS STEEL  
premium selection

Farbe 16 Edelstahl, Federscharnier, Kunststoffbügel

- Größen 50-17  
Farben 08  
14  
16  
50  
17  
135  
29  
15

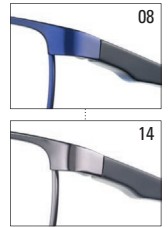

TOP PREIS LEISTUNG

Start Up Premium **7928**

**NEU**

**STARTUP**  
premium



STAINLESS STEEL  
premium selection

Farbe 16 Edelstahl, Federscharnier, Kunststoffbügel

- Größen 54-17  
Farben 08  
14  
16  
54  
17  
140  
32  
15

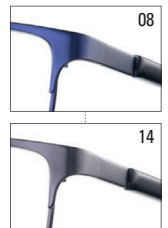



Start Up Premium

TOP PREIS LEISTUNG

Start Up Premium 7903



**STARTUP**  
premium

- Größen 58-18  
 Farben 08  
 12  
 16  
 58  
 18  
 140  
 37  
 21

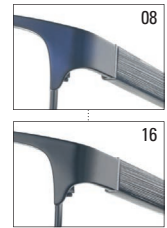

Farbe 12 Edelstahl, Federscharnier, Kunststoffbügel

STAINLESS STEEL  
premium selection

TOP PREIS LEISTUNG

Start Up Premium 7902



**STARTUP**  
premium

- Größen 55-18  
 Farben 08  
 14  
 16  
 55  
 18  
 140  
 37  
 18

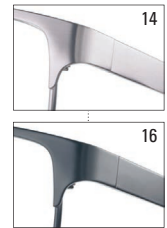

Farbe 08 Edelstahl, Federscharnier

STAINLESS STEEL  
premium selection

TOP PREIS LEISTUNG

Start Up Premium 7901



**STARTUP**  
premium

- Größen 52-18  
 Farben 08  
 14  
 16  
 52  
 18  
 140  
 31  
 20

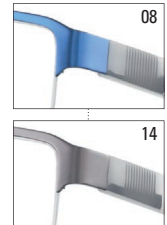

Farbe 16 Edelstahl, Federscharnier, Kunststoffbügel

STAINLESS STEEL  
premium selection

TOP PREIS LEISTUNG

Start Up Premium 7900



**STARTUP**  
premium

- Größen 52-18  
 Farben 08  
 14  
 16  
 52  
 18  
 140  
 32  
 17

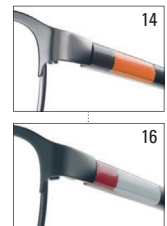

Farbe 08 Edelstahl, Federscharnier, Kunststoffbügel

STAINLESS STEEL  
premium selection

TOP PREIS LEISTUNG

Start Up Premium 7899

**STARTUP**  
premium



STAINLESS STEEL  
*premium selection*

Farbe 16 Edelstahl, Federscharnier, Kunststoffbügel

- Größen 53-18  
Farben 08  
14  
16  
53  
18  
140  
32  
17

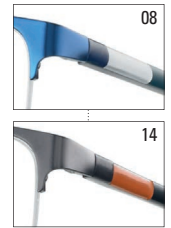

TOP PREIS LEISTUNG

Start Up Premium 7898

**STARTUP**  
premium



STAINLESS STEEL  
*premium selection*

Farbe 14 Edelstahl, Federscharnier, Kunststoffbügel

- Größen 55-18  
Farben 14  
15  
16  
55  
18  
140  
35  
21

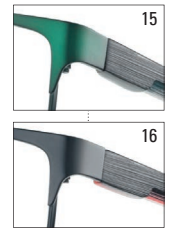

TOP PREIS LEISTUNG

Start Up Premium 7897

**STARTUP**  
premium



STAINLESS STEEL  
*premium selection*

Farbe 16 Edelstahl, Federscharnier, Kunststoffbügel

- Größen 55-18  
Farben 08  
12  
16  
55  
18  
140  
33  
16

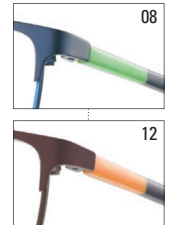

TOP PREIS LEISTUNG

Start Up Premium 7896

**STARTUP**  
premium



STAINLESS STEEL  
*premium selection*

Farbe 14 Edelstahl, Federscharnier, Kunststoffbügel

- Größen 53-17  
Farben 08  
14  
16  
53  
17  
140  
33  
19

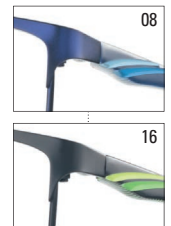

TOP PREIS LEISTUNG

Start Up Premium **7894**

**STARTUP**  
premium



STAINLESS STEEL  
premium selection

Farbe 16 Edelstahl

- Größen 55-17  
Farben 08  
15  
16  
55  
17  
145  
37  
14

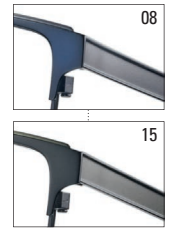

TOP PREIS LEISTUNG

Start Up Premium **7893**

**STARTUP**  
premium



STAINLESS STEEL  
premium selection

Farbe 08 Edelstahl, Federscharnier, Kunststoffbügel

- Größen 56-18  
Farben 08  
12  
16  
56  
18  
140  
37  
23

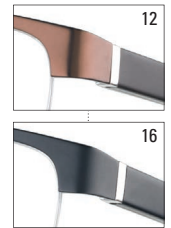

TOP PREIS LEISTUNG

Start Up Premium **7892**

**STARTUP**  
premium



STAINLESS STEEL  
premium selection

Farbe 16 Edelstahl, Federscharnier, Kunststoffbügel

- Größen 57-19  
Farben 08  
12  
16  
57  
19  
140  
36  
20

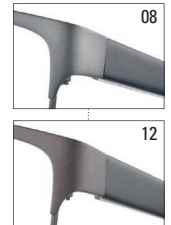

TOP PREIS LEISTUNG

Start Up Premium **7891**

**STARTUP**  
premium



STAINLESS STEEL  
premium selection

Farbe 08 Edelstahl, Federscharnier, Kunststoffbügel

- Größen 55-17  
Farben 08  
14  
16  
55  
17  
140  
34  
18

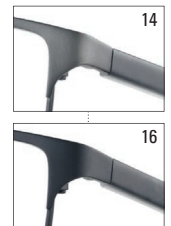

TOP PREIS LEISTUNG

Start Up Premium **7846**

**STARTUP**  
premium



STAINLESS STEEL  
premium selection

Farbe 14 Edelstahl, Federscharnier, Kunststoffbügel

- Größen 54-18  
Farben 12  
14  
16  
54  
18  
140  
34  
20

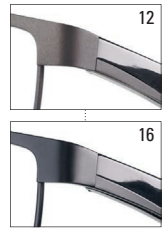

TOP PREIS LEISTUNG

Start Up Premium **7829**

**STARTUP**  
premium



STAINLESS STEEL  
premium selection

Farbe 16 Edelstahl, Federscharnier

- Größen 52-17  
Farben 08  
12  
16  
52  
17  
140  
35  
20

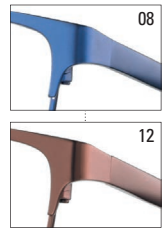

TOP PREIS LEISTUNG

Start Up Premium **7825**

**STARTUP**  
premium



STAINLESS STEEL  
premium selection

Farbe 16 Edelstahl, Federscharnier, Kunststoffbügel

- Größen 58-18  
Farben 08  
14  
16  
58  
18  
140  
35  
22

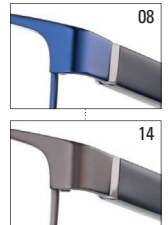

TOP PREIS LEISTUNG

Start Up Premium **7807**

**STARTUP**  
premium



STAINLESS STEEL  
premium selection

Farbe 16 Edelstahl, Federscharnier

- Größen 58-18  
Farben 08  
12  
16  
58  
18  
140  
36  
21

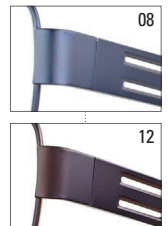

TOP PREIS LEISTUNG

Start Up Premium **7803**

**STARTUP**  
premium



**STAINLESS STEEL**  
*premium selection*

Farbe 14 Edelstahl, Federscharnier, Kunststoffbügel

- Größen 57-19  
Farben 08  
14  
16  
57  
19  
140  
35  
20

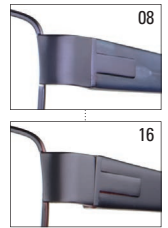

TOP PREIS LEISTUNG

Start Up Premium **6203**

**NEU**

**STARTUP**  
premium



**XTRA LIGHT ACETATE**  
*premium selection*

Farbe 08 Zelluloseacetat, Federscharnier

- Größen 54-17  
Farben 08  
10  
12  
16  
54  
17  
140  
31  
13

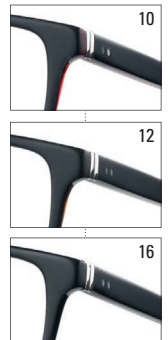

TOP PREIS LEISTUNG

Start Up Premium **6202**

**NEU**

**STARTUP**  
premium



**HAND MADE ACETATE**  
*premium selection*

Farbe 08 Zelluloseacetat, Federscharnier

- Größen 54-16  
Farben 08  
12  
16  
54  
16  
148  
30  
16

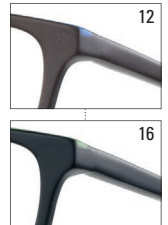

TOP PREIS LEISTUNG

Start Up Premium **6198**

**NEU**

**STARTUP**  
premium



**XTRA LIGHT ACETATE**  
*premium selection*

Farbe 16 Zelluloseacetat

- Größen 55-16  
Farben 08  
12  
14  
16  
55  
16  
140  
39  
11

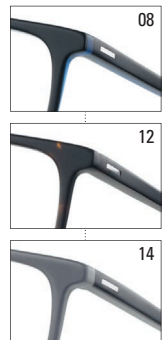



TOP PREIS LEISTUNG

Start Up Premium **6197**

**NEU**

**STARTUP**  
premium



HAND MADE ACETATE  
premium selection

Farbe 08 Zelluloseacetat, Federscharnier

- Größen 54-16  
Farben 08  
15  
16  
54  
16  
140  
31  
17

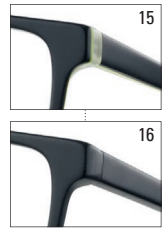

TOP PREIS LEISTUNG

Start Up Premium **6196**

**NEU**

**STARTUP**  
premium



XTRA LIGHT ACETATE  
premium selection

Farbe 12 Zelluloseacetat, Federscharnier

- Größen 55-16  
Farben 08  
12  
16  
55  
16  
140  
33  
14

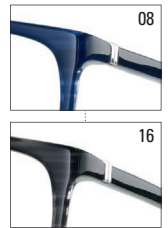

TOP PREIS LEISTUNG

Start Up Premium **6180**

**STARTUP**  
premium



HAND MADE ACETATE  
premium selection

Farbe 07 Zelluloseacetat, Federscharnier

- Größen 50-16  
Farben 07  
08  
16  
50  
16  
135  
32  
16

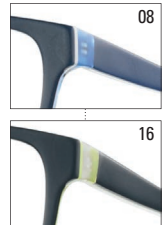

TOP PREIS LEISTUNG

Start Up Premium **6179**

**STARTUP**  
premium



HAND MADE ACETATE  
premium selection

Farbe 16 Zelluloseacetat, Federscharnier

- Größen 54-16  
Farben 08  
10  
16  
54  
16  
140  
32  
18

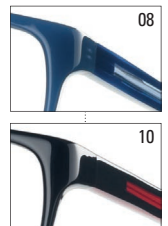

TOP PREIS LEISTUNG

Start Up Premium 6178

STARTUP premium



- Größen 55-17  
 Farben 12  
 15  
 16  
 55  
 17  
 140  
 36  
 16

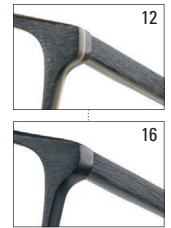

Farbe 15 Zelluloseacetat, Federscharnier

HAND MADE ACETATE  
 premium selection

TOP PREIS LEISTUNG

Start Up Premium 6176

STARTUP premium



- Größen 52-15  
 Farben 08  
 14  
 16  
 52  
 15  
 140  
 31  
 18

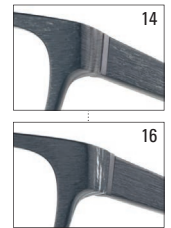

Farbe 08 Zelluloseacetat, Federscharnier

HAND MADE ACETATE  
 premium selection

TOP PREIS LEISTUNG

Start Up Premium 6175

STARTUP premium



- Größen 57-16  
 Farben 12  
 14  
 16  
 57  
 16  
 145  
 39  
 18

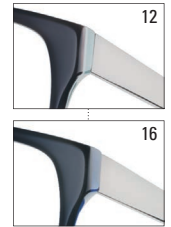

Farbe 14 Zelluloseacetat, Federscharnier, Metallbügel

HAND MADE ACETATE  
 premium selection

TOP PREIS LEISTUNG

Start Up Premium 6174

STARTUP premium



- Größen 56-18  
 Farben 08  
 14  
 16  
 56  
 18  
 140  
 35  
 17

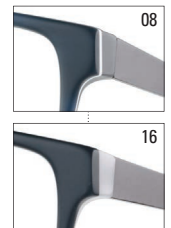

Farbe 14 Zelluloseacetat, Federscharnier, Metallbügel

HAND MADE ACETATE  
 premium selection

TOP PREIS LEISTUNG

Start Up Premium **6153**

**STARTUP**  
premium



HAND MADE ACETATE  
premium selection

Farbe 16 Zelluloseacetat

- Größen 54-18  
Farben 08  
14  
16  
54  
18  
145  
35  
21

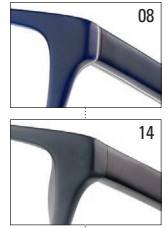

TOP PREIS LEISTUNG

Start Up Premium **6152**

**STARTUP**  
premium



HAND MADE ACETATE  
premium selection

Farbe 08 Zelluloseacetat

- Größen 54-16  
Farben 08  
12  
16  
54  
16  
140  
33  
20

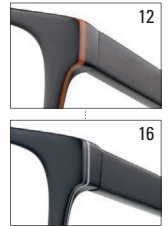

TOP PREIS LEISTUNG

Start Up Premium **6140**

**STARTUP**  
premium



HAND MADE ACETATE  
premium selection

Farbe 14 Zelluloseacetat, Federscharnier

- Größen 56-17  
Farben 04  
08  
14  
56  
17  
140  
32  
21

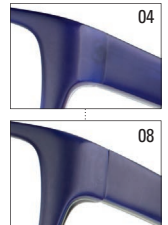

TOP PREIS LEISTUNG

Start Up Premium **5445** **NEU**

**STARTUP**  
premium



XTRA LIGHT ACETATE  
premium selection

Farbe 16 Zelluloseacetat, Federscharnier

- Größen 51-17  
Farben 08  
10  
12  
16  
51  
17  
140  
35  
15

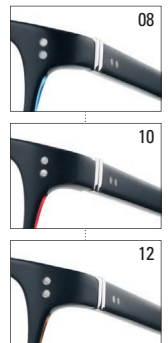

TOP PREIS LEISTUNG

Start Up Premium **5442**

**NEU**

**STARTUP**  
premium



XTRA LIGHT ACETATE  
premium selection

Farbe 12 Zelluloseacetat

Größen 53-16  
Farben 10

- 12
- 14
- 16
- 53
- 16
- 140
- 41
- 12

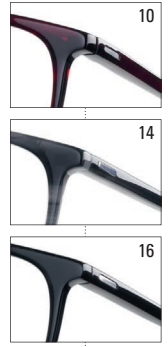

TOP PREIS LEISTUNG

Start Up Premium **5430**

**STARTUP**  
premium



XTRA LIGHT ACETATE  
premium selection

Farbe 16 Zelluloseacetat, Federscharnier

Größen 53-17  
Farben 08

- 10
- 12
- 16
- 53
- 17
- 140
- 39
- 14

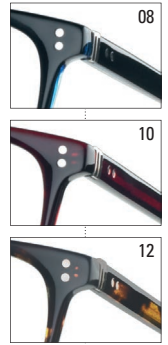

TOP PREIS LEISTUNG

Start Up Premium **5429**

**STARTUP**  
premium



XTRA LIGHT ACETATE  
premium selection

Farbe 10 Zelluloseacetat, Federscharnier

Größen 53-15  
Farben 10

- 12
- 16
- 53
- 15
- 140
- 35
- 14

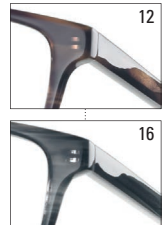

TOP PREIS LEISTUNG

Start Up Premium **5428**

**STARTUP**  
premium



XTRA LIGHT ACETATE  
premium selection

Farbe 12 Zelluloseacetat, Federscharnier

Größen 50-18  
Farben 08

- 10
- 12
- 16
- 50
- 18
- 140
- 39
- 14

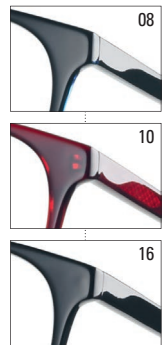

TOP PREIS LEISTUNG

Start Up Premium **5427**

**STARTUP**  
premium



XTRA LIGHT ACETATE  
premium selection

Farbe 16 Zelluloseacetat, Federscharnier

- Größen 48-17  
Farben 10  
12  
16  
48  
17  
138  
38  
14

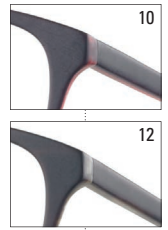

TOP PREIS LEISTUNG

Start Up Premium **5426**

**STARTUP**  
premium



XTRA LIGHT ACETATE  
premium selection

Farbe 10 Zelluloseacetat, Federscharnier

- Größen 50-17  
Farben 10  
15  
16  
50  
17  
135  
32  
11

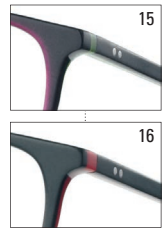

TOP PREIS LEISTUNG

Start Up Premium **5425**

**STARTUP**  
premium



HAND MADE ACETATE  
premium selection

Farbe 15 Zelluloseacetat, Federscharnier

- Größen 55-14  
Farben 10  
15  
16  
55  
14  
135  
35  
15

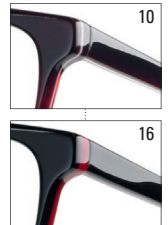

TOP PREIS LEISTUNG

Start Up Premium **5423**

**STARTUP**  
premium



HAND MADE ACETATE  
premium selection

Farbe 12 Zelluloseacetat, Federscharnier

- Größen 53-16  
Farben 12  
14  
16  
53  
16  
135  
35  
19

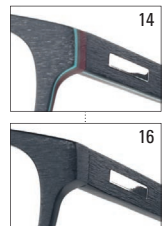



TOP PREIS LEISTUNG

Start Up Premium **5418**



**STARTUP**  
premium

- Größen 53 -17  
 Farben 12  
 14  
 16  
 53  
 17  
 135  
 38  
 15

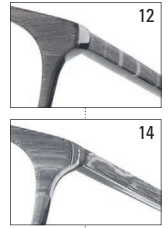

HAND MADE ACETATE  
premium selection

Farbe 16 Zelluloseacetat, Federscharnier

TOP PREIS LEISTUNG

Start Up Premium **5416**



**STARTUP**  
premium

- Größen 53-16  
 Farben 10  
 16  
 17  
 53  
 16  
 135  
 39  
 17

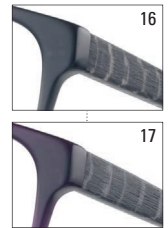

HAND MADE ACETATE  
premium selection

Farbe 10 Zelluloseacetat, Federscharnier

TOP PREIS LEISTUNG

Start Up Premium **5403**



**STARTUP**  
premium

- Größen 52-18  
 Farben 10  
 16  
 52  
 18  
 135  
 36  
 19



HAND MADE ACETATE  
premium selection

Farbe 16 Zelluloseacetat, Federscharnier

TOP PREIS LEISTUNG

Start Up Premium **5402**



**STARTUP**  
premium

- Größen 52-15  
 Farben 14  
 16  
 17  
 52  
 15  
 135  
 34  
 18

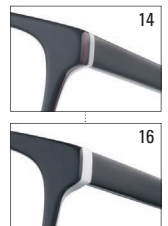

HAND MADE ACETATE  
premium selection

Farbe 17 Zelluloseacetat, Federscharnier

TOP PREIS LEISTUNG

Start Up Premium **5401**

**STARTUP**  
premium



- Größen 52-15  
 Farben 14  
 16  
 17  
 52  
 15  
 135  
 34  
 16

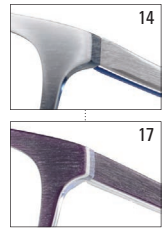

Farbe 16 Zelluloseacetat, Federscharnier

HAND MADE ACETATE  
premium selection

TOP PREIS LEISTUNG

Start Up Fashion **2532**

**STARTUP**  
fashion



- Größen 50-17  
 Farben 10  
 12  
 16  
 50  
 17  
 135  
 35  
 20

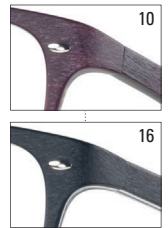

Farbe 12 Zelluloseacetat, Federscharnier

HAND MADE ACETATE  
premium selection

TOP PREIS LEISTUNG

Start Up Fashion **2531**

**STARTUP**  
fashion



- Größen 45-19  
 Farben 10  
 12  
 14  
 45  
 19  
 140  
 36  
 16

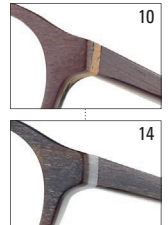

Farbe 12 Zelluloseacetat, Federscharnier

HAND MADE ACETATE  
premium selection

TOP PREIS LEISTUNG

Start Up Fashion **2530**

**STARTUP**  
fashion



- Größen 52-16  
 Farben 12  
 14  
 16  
 52  
 16  
 135  
 31  
 15

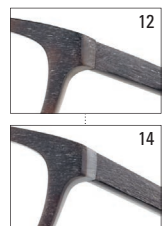

Farbe 16 Zelluloseacetat, Federscharnier

HAND MADE ACETATE  
premium selection

TOP PREIS LEISTUNG

Start Up Fashion **2529**

**STARTUP**  
fashion



Unterschiedliche  
Glasformen\*

STAINLESS STEEL  
premium selection

Farbe 08\* Edelstahl, Bohrbrille

|        |       |
|--------|-------|
| Größen | 50-17 |
| Farben | 08    |
|        | 10    |
|        | 14    |
|        | 15    |
|        | 50    |
|        | 17    |
|        | 138   |
|        | 30/32 |
|        | 09    |

|        |       |
|--------|-------|
| Größen | 53-17 |
| Farbe  | 16    |
|        | 53    |
|        | 17    |
|        | 138   |
|        | 32    |
|        | 09    |

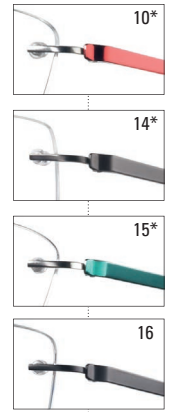

TOP PREIS LEISTUNG

Start Up Fashion **2528**

**STARTUP**  
fashion



HAND MADE ACETATE  
premium selection

Farbe 08 Zelluloseacetat

|        |       |
|--------|-------|
| Größen | 51-16 |
| Farben | 08    |
|        | 10    |
|        | 16    |
|        | 51    |
|        | 16    |
|        | 145   |
|        | 30    |
|        | 16    |

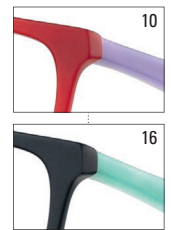

TOP PREIS LEISTUNG

Start Up Fashion **2522**

**STARTUP**  
fashion



HAND MADE ACETATE  
premium selection

Farbe 17 Zelluloseacetat

|        |       |
|--------|-------|
| Größen | 50-16 |
| Farben | 08    |
|        | 10    |
|        | 17    |
|        | 50    |
|        | 16    |
|        | 135   |
|        | 27    |
|        | 16    |

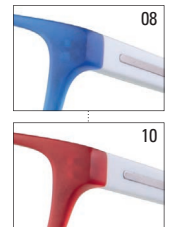

TOP PREIS LEISTUNG

Start Up Fashion **2519**

**STARTUP**  
fashion



HAND MADE ACETATE  
premium selection

Farbe 10 Zelluloseacetat

|        |       |
|--------|-------|
| Größen | 52-16 |
| Farben | 04    |
|        | 08    |
|        | 10    |
|        | 52    |
|        | 16    |
|        | 135   |
|        | 29    |
|        | 17    |

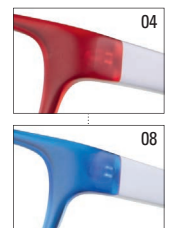

TOP PREIS LEISTUNG

Start Up Fashion **2518**

**STARTUP**  
fashion



STAINLESS STEEL  
premium selection

Farbe 16 Edelstahl, Federscharnier

- Größen 47-18  
Farben 08  
14  
16  
47  
18  
135  
25  
18

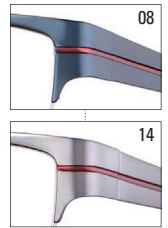

TOP PREIS LEISTUNG

Start Up Fashion **2517**

**STARTUP**  
fashion



STAINLESS STEEL  
premium selection

Farbe 14 Edelstahl, Federscharnier

- Größen 49-17  
Farben 08  
14  
16  
49  
17  
135  
27  
15

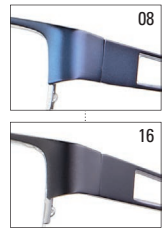

TOP PREIS LEISTUNG

Start Up Fashion **2511**

**STARTUP**  
fashion



HAND MADE ACETATE  
premium selection

Farbe 08 Zelluloseacetat

- Größen 54-17  
Farben 08  
14  
16  
54  
17  
140  
31  
19

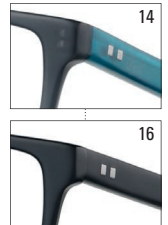

TOP PREIS LEISTUNG

Start Up Fashion **2498**

**STARTUP**  
fashion



STAINLESS STEEL  
premium selection

Farbe 14 Edelstahl, Federscharnier, Kunststoffbügel

- Größen 50-18  
Farben 08  
14  
16  
50  
18  
135  
23  
16

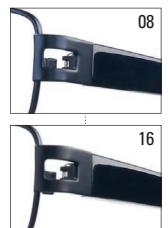

TOP PREIS LEISTUNG

Start Up Classic **8167**

**STARTUP**  
classic



STAINLESS STEEL  
premium selection

Farbe 12 Edelstahl, Federscharnier

- Größen 52-17  
54-17  
Farben 02  
12  
52/54  
17  
135  
35/37  
15



02

TOP PREIS LEISTUNG

Start Up Classic **8127**

**STARTUP**  
classic



STAINLESS STEEL  
premium selection

Farbe 10 Edelstahl, Federscharnier, Kunststoffbügel

- Größen 51-17  
53-17  
Farben 10  
12  
14  
51/53  
17  
135  
29/31  
16



12



14

TOP PREIS LEISTUNG

Start Up Classic **8126**

**STARTUP**  
classic



STAINLESS STEEL  
premium selection

Farbe 12 Edelstahl, Federscharnier, Kunststoffbügel

- Größen 52-18  
54-18  
Farben 10  
12  
14  
52/54  
18  
135  
34/35  
16



10

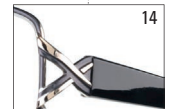

14

TOP PREIS LEISTUNG

Start Up Classic **7890**

**STARTUP**  
classic



STAINLESS STEEL  
premium selection

Farbe 14 Federscharnier

- Größen 55-19  
57-19  
Farben 02  
14  
55/57  
19  
140  
35/37  
21



02



TOP PREIS LEISTUNG

Start Up Classic **7866**

**STARTUP**  
classic



**STAINLESS STEEL**  
premium selection

Farbe 12 Edelstahl, Federscharnier, Kunststoffbügel

- Größen 52-18  
54-18  
Farben 12  
14  
52/54  
18  
140  
33/35  
16



TOP PREIS LEISTUNG

Start Up Classic **7865**

**STARTUP**  
classic



**STAINLESS STEEL**  
premium selection

Farbe 14 Edelstahl, Federscharnier, Kunststoffbügel

- Größen 52-18  
54-18  
Farben 12  
14  
52/54  
18  
140  
33/35  
16



TOP PREIS LEISTUNG

Start Up Classic **7850**

**STARTUP**  
classic



**STAINLESS STEEL**  
premium selection

Farbe 02 Edelstahl, Federscharnier

- Größen 53-19  
55-19  
Farben 02  
14  
53/55  
19  
140  
34/36  
19



TOP PREIS LEISTUNG

Start Up Classic **7849**

**STARTUP**  
classic



**STAINLESS STEEL**  
premium selection

Farbe 14 Edelstahl, Federscharnier

- Größen 54-19  
56-19  
Farben 02  
14  
54/56  
19  
140/145  
35/37  
20



TOP PREIS LEISTUNG

Start Up Classic **7848**

**STARTUP**  
classic



STAINLESS STEEL  
premium selection

- Größen 54-18  
56-18  
Farben 12  
14  
54/56  
18  
140  
35/37  
16



12

Farbe 14 Edelstahl, Federscharnier, Kunststoffbügel, Vollsteg

TOP PREIS LEISTUNG

Start Up Classic **6160**

**STARTUP**  
classic



HAND MADE ACETATE  
premium selection

- Größen 56-16  
58-16  
Farben 12  
14  
16  
56/58  
16  
145  
37/38  
19



12



14

Farbe 16 Zelluloseacetat, Federscharnier

TOP PREIS LEISTUNG

Start Up Classic **6159**

**STARTUP**  
classic



HAND MADE ACETATE  
premium selection

- Größen 54-16  
56-16  
Farben 12  
14  
16  
54/56  
16  
140  
36/37  
15



14



16

Farbe 12 Zelluloseacetat, Federscharnier, Metallbügel

TOP PREIS LEISTUNG

Start Up Classic **5422**

**STARTUP**  
classic



HAND MADE ACETATE  
premium selection

- Größen 52-15  
54-15  
Farben 10  
12  
52/54  
15  
130  
36/37  
17



12

Farbe 10 Zelluloseacetat, Federscharnier, Metallbügel

TOP PREIS LEISTUNG

Start Up Classic **5420**



**STARTUP**  
classic

- Größen 52-16  
 Farben 10  
 12  
 17  
 52  
 16  
 135  
 36  
 18

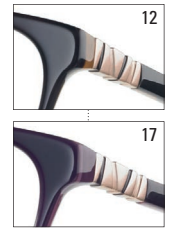

12

17

Farbe 10 Zelluloseacetat, Federscharnier

HAND MADE ACETATE  
premium selection

TOP PREIS LEISTUNG

Start Up Classic **5419**



**STARTUP**  
classic

- Größen 52-17  
 Farben 10  
 12  
 14  
 52  
 17  
 135  
 36  
 17

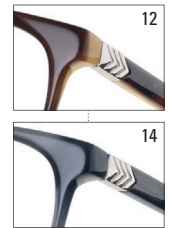

12

14

Farbe 10 Zelluloseacetat, Federscharnier

HAND MADE ACETATE  
premium selection

TOP PREIS LEISTUNG

Start Up Classic **5405**



**STARTUP**  
classic

- Größen 50-16  
 52-16  
 Farben 10  
 12  
 50/52  
 16  
 130  
 32/34  
 18



10

Farbe 12 Zelluloseacetat, Federscharnier

HAND MADE ACETATE  
premium selection

TOP PREIS LEISTUNG

Start Up Classic **5404**



**STARTUP**  
classic

- Größen 53-16  
 Farben 10  
 12  
 53  
 16  
 135  
 34  
 17



12

Farbe 10 Zelluloseacetat, Federscharnier

HAND MADE ACETATE  
premium selection

Start Up Readers

TOP PREIS LEISTUNG

Start Up Readers 1172



STAINLESS STEEL  
premium selection

Farbe 14 Edelstahl, Federscharnier, Kunststoffbügel

Größen 52-21

- Farben 08  
12  
14  
16  
52  
21  
145  
29  
18

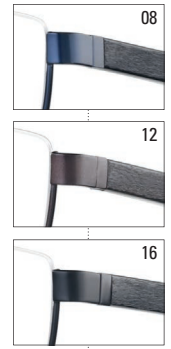

TOP PREIS LEISTUNG

Start Up Readers 1171



STAINLESS STEEL  
premium selection

Farbe 12 Edelstahl, Federscharnier, Kunststoffbügel

Größen 51-21

- Farben 08  
12  
14  
51  
21  
145  
22  
17

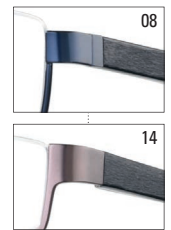

TOP PREIS LEISTUNG

Start Up Readers 1166



STAINLESS STEEL  
premium selection

Farbe 14 Edelstahl, Federscharnier, Kugelschreiber-Clip

Größen 52-21

- Farben 02  
14  
16  
52  
21  
145  
26  
17



TOP PREIS LEISTUNG

Start Up Readers 1152



STAINLESS STEEL  
premium selection

Farbe 12 Edelstahl, Federscharnier, Kunststoffbügel

Größen 47-20

- Farben 08  
12  
16  
47  
20  
145  
21  
20

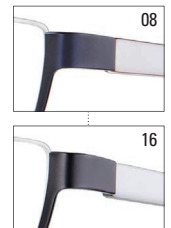

TOP PREIS LEISTUNG

Start Up Readers 1150

**STARTUP**  
readers



**STAINLESS STEEL**  
*premium selection*

Farbe 14 Edelstahl, Federscharnier, Kunststoffbügel

- Größen 51-20  
Farben 08  
14  
16  
51  
20  
145  
22  
18

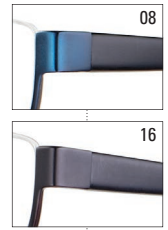

TOP PREIS LEISTUNG

Start Up Readers 1149

**STARTUP**  
readers



**STAINLESS STEEL**  
*premium selection*

Farbe 16 Edelstahl, Federscharnier, Kunststoffbügel

- Größen 52-21  
Farben 08  
14  
16  
52  
21  
145  
26  
18

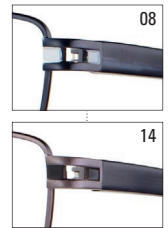

TOP PREIS LEISTUNG

Start Up Readers 1114

**STARTUP**  
readers



Farbe 16 Federscharnier

- Größen 50-21  
52-21  
Farben 02  
14  
16  
50/52  
21  
145  
24/25  
16



TOP PREIS LEISTUNG

Start Up Readers 1072

**STARTUP**  
readers



Farbe 08 Federscharnier

- Größen 49-19  
Farben 08  
12  
16  
49  
19  
145  
21  
10

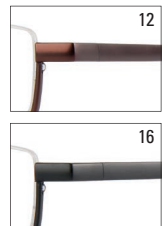



TOP PREIS LEISTUNG

Start Up Readers **1052**

**STARTUP**  
readers



- Größen 50-21  
52-21  
Farben 02  
08  
14  
50/52  
21  
145  
27/29  
13

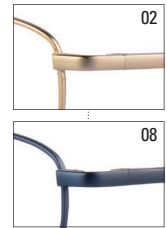

Farbe 14 Federscharnier

TOP PREIS LEISTUNG

Start Up Readers **1041**

**STARTUP**  
readers



- Größen 49-21  
Farben 02  
08  
14  
49  
21  
145  
25  
12

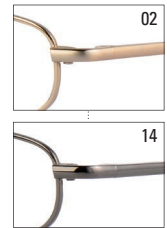

Farbe 08 Federscharnier

TOP PREIS LEISTUNG

Start Up Basics **8951**

**STARTUP**  
basics



- Größen 48-18  
50-18  
52-18  
Farben 02  
11  
17  
48/50/52  
18  
135  
30/31/32  
13

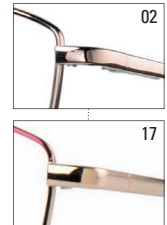

Farbe 11 Federscharnier

TOP PREIS LEISTUNG

Start Up Basics **7743**

**STARTUP**  
basics



- Größen 50-18  
52-18  
Farben 01  
02  
14  
16  
50/52  
18  
140  
32/33  
13

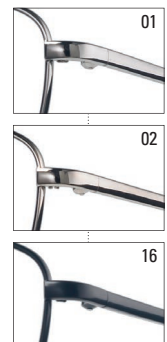

Farbe 14





TOP PREIS LEISTUNG

Start Up Basics **7742**

**STARTUP**  
basics



Farbe 16

- Größen 52-18  
54-18
- Farben 01  
02  
14  
16
-  52/54  
 18  
 140  
 34/35  
 14

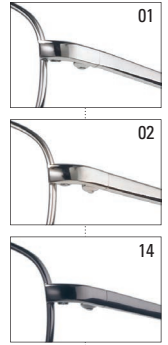





TOP PREIS LEISTUNG

Start Up Basics **7701**

**STARTUP**  
basics



Farbe 16 Federscharnier

- Größen 50-18  
52-18  
54-18
- Farben 02  
14  
16
-  50/52/54  
 18  
 140  
 28/29/30  
 13







TOP PREIS LEISTUNG

Start Up Basics **7700**

**STARTUP**  
basics



Farbe 14 Federscharnier

- Größen 51-19  
53-19  
55-19
- Farben 02  
14  
16
-  51/53/55  
 19  
 140  
 32/33/34  
 14







TOP PREIS LEISTUNG

Start Up Basics **7699**

**STARTUP**  
basics



Farbe 02 Federscharnier

- Größen 52-19  
54-19  
56-19
- Farben 02  
14  
16
-  52/54/56  
 19  
 140  
 36/37/38  
 16

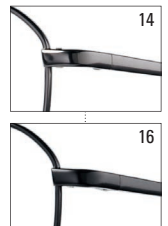

TOP PREIS LEISTUNG

Start Up Basics **2504**

**STARTUP**  
basics



- Größen 48-18  
 Farben 08  
 14  
 16  
 48  
 18  
 135  
 26  
 11

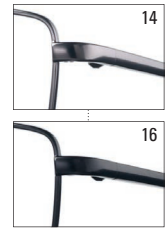

Farbe 08

TOP PREIS LEISTUNG

Start Up Basics **1129**

**STARTUP**  
basics



- Größen 47-21  
 49-21  
 Farben 02  
 12  
 14  
 16  
 47/49  
 21  
 145  
 26/27  
 13

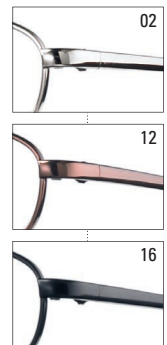

Farbe 14

TOP PREIS LEISTUNG

Start Up Basics **1112**

**STARTUP**  
basics



- Größen 48-23  
 50-23  
 Farben 01  
 02  
 14  
 16  
 48/50  
 23  
 145  
 26/27  
 13

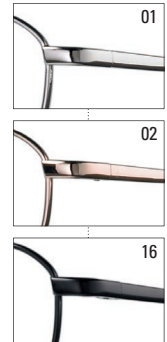

Farbe 14 Federscharnier











## Aufsteller

DIN A5  
2 Seiten  
4-farbig



## Flyer

DIN lang  
2 Seiten  
4/4-farbig







## Imageanzeigen

DIN A5  
4-farbig



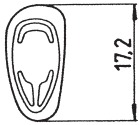
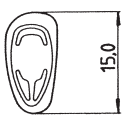
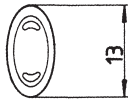

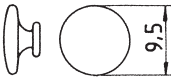
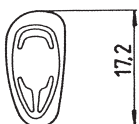
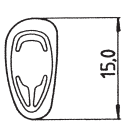
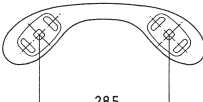
**Sie haben keine Marketingmappe bekommen?**

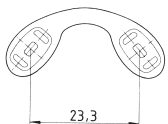
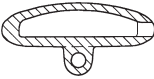
Fordern Sie Ihr Exemplar an unter: [bestellung@binde-optik.de](mailto:bestellung@binde-optik.de) oder telefonisch 0571 / 28013 bei unserer Marketingexpertin Kirsten Lorenz.

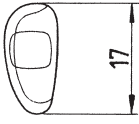
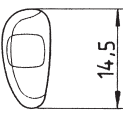
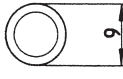
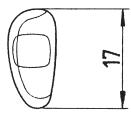
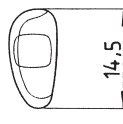
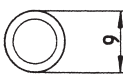
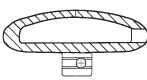
| Silicon-Pads  |   |   |  |   |
|---|---|---|--|---|
| Click-System  | Click-System  | Click-System  | Click-System   | Mono Pad  |
|  |  |  |  |  |
| Best.-Nr. 448   | Best.-Nr. 411   | Best.-Nr. 414   | Best.-Nr. 407  | Best.-Nr. 409   |
| Schraub-System  | Schraub-System  | Click-System  | Schraub-System   | Schraub-System  |
|  |  |  |  |  |
| Best.-Nr. 449   | Best.-Nr. 412   | Best.-Nr. 447   | Best.-Nr. 445  | Best.-Nr. 465   |
| Air Active (145 mm)   |   |   |  |   |
| Schraub-System  |   |   |  |   |
|  |   |   |  |   |
| Best.-Nr. 471   |   |   |  |   |

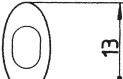
| PVC-Pads (Phthalat-Frei)  |   |   |  |   |
|---|---|---|--|---|
| Click-System  | Click-System  | Click-System  | Schraub-System   | Schraub-System  |
|  |  |  |  |  |
| Best.-Nr. 405   | Best.-Nr. 400   | Best.-Nr. 422   | Best.-Nr. 410  | Best.-Nr. 401   |
| Schraub-System  | Air Active (130 mm)   |   |  |   |
|  |  |   |  |   |
| Best.-Nr. 423   | Best.-Nr. 472   |   |  |   |

| Titan-Pads (pur Titan)  |   |
|---|---|
| Click-System  | Schraub-System  |
|  |  |
| Best.-Nr. 462   | Best.-Nr. 463   |









### Sortiment (Pads)

Folgende Pads bieten wir Ihnen als Sortiment zum günstigeren Einkaufspreis an (1 VE: 5 Paar Pads):

(Silicon - Pads) 407; 409; 411; 412; 414 ; 448; 449

(Esprit - Pads) 400; 401; 405; 410; 422; 423

**Bitte sortieren Sie selbst.**

| Cellenden (1 Pack: 10 Stück) |   |            |       |         |
|------------------------------|---|------------|-------|---------|
| Best.-Nr.                    | Abbildung   | Farbe      | Länge | Bohrung |
| 316                          |  | schwarz    | 65 mm | 1,5 mm  |
| 317                          |  | braun      | 65 mm | 1,5 mm  |
| 320                          |  | braun      | 75 mm | 1,5 mm  |
| 321                          |  | schwarz    | 75 mm | 1,5 mm  |
| 324                          |  | schwarz    | 70 mm | 1,9 mm  |
| 326-12                       |  | braun      | 63 mm | 1,5 mm  |
| 326-14                       |  | Titan grau | 63 mm | 1,5 mm  |
| 327-12                       |  | braun      | 65 mm | 1,5 mm  |
| 327-14                       |  | Titan grau | 65 mm | 1,5 mm  |

| Zubehör         |  |             |           |
|-----------------|--|-------------|-----------|
| Beschreibung    | Abbildung  | Länge/Menge | Best.-Nr. |
| Etikettenträger |  | 500 Stück   | 377       |

| Brillenkordeln  |  |
|---|--|
| Abbildung   | Beschreibung   |
|  | - 2 = schwarz<br>- 3 = bunt-sortiert<br><br>1 Verpackungseinheit: 12 Stück |
|   | Best.-Nr.<br>956   |

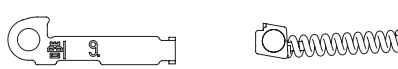
| OBE-Federscharnier (flexUno)   |  |          |           |
|--|--|----------|-----------|
| Beschreibung   | Abbildung  | Menge    | Best.-Nr. |
| Einsatz + Feder, <b>3.0</b> Metallbügel<br>BI 4266, 4267, 4268, 4269, 4270                 |  | 10 Stück | 82        |
| Einsatz + Feder, <b>2.7</b> Kunststoffbügel<br>BI 4271, 4272, 4273, 4277, 4278, 4279, 4280 |  | 10 Stück | 83        |

# ZERTIFIKAT

## zur Biokompatibilität

### Allergie Schutzlackierung für Brillengestelle (VC-80075 Dreikomponenten-Klarlack)

### Passive Oberflächenveredelung durch

Binde Optik GmbH & Co. KG  
Postfach 2160 · D-32378 Minden

### Prüfungen zur Biokompatibilität

Wir bestätigen, daß die folgenden Prüfungen zur Bestimmung der Biokompatibilität gemäß der internationalen Norm DIN EN ISO 10993-1: 1998 "Biologische Beurteilung von Medizinprodukten - Teil 1: Beurteilung und Prüfung" durchgeführt wurden:

#### 1. Zytotoxizitätsprüfung

Die potentielle zelltoxische Wirkung der mit VC-80075 Dreikomponenten-Klarlack behandelten Neusilber Prüflinge wurde im Vergleich zu nicht-lackierten Prüflingen aus Neusilber in-vitro gemäß ISO 10993-5: 1992 im Wachstumshemmtest untersucht. Der unverdünnte Materialextrakt der lackierten Prüflinge löste eine Wachstumshemmung von 43 % aus, die in der nächsten Verdünnungsstufe nicht mehr nachweisbar war. Der unverdünnte Extrakt der nicht-lackierten Prüflinge verursachte eine vollständige Wachstumshemmung.

#### 2. Sensibilisierungsprüfung

Die potentielle allergieauslösende Wirkung der mit VC-80075 Dreikomponenten-Klarlack behandelten Neusilber Prüflinge wurde in-vivo gemäß ISO 10993-10: 1995 im Maximierungstest nach Magnusson & Kligman untersucht. Die Prüfung ergab keine Hinweise auf sensibilisierende Eigenschaften.

mdt medical device testing GmbH  
Schloßstraße 17 · 88416 Ochsenhausen



---

Dr. Dieter R. Dannhorn, 12.08.1999

## Allergieschutzbeschichtung

- › Allergieschutzbeschichtung gegen Nickelaustritt für alle Metallfassungen. (Auch für Fremdfassungen)
- › Die Farbechtheit der Fassung(en) bleibt weitgehend erhalten.
- › Besteht ohne Probleme den Schweißtest der DIN EN ISO 12870.
- › Diese Beschichtung erfüllt die DIN EN ISO 10993. (Biologische Beurteilung von Medizinprodukten)
- › Die aufgetragene Beschichtung wird auf Dichtigkeit kontrolliert. Nickeltest nach CR 12471 (screening-test).
- › Beginnend mit dem Tag der Auslieferung hält die Allergieschutzbeschichtung mindestens 12 Monate.

### Hinweis:

Bei Einsendung der Brillenfassung(en), entfernen Sie bitte vorher alle nichtmetallischen Teile (Pad's, Cellenden, Celloberteile, usw.). Steg-, Bügel- und Bohrbrillenschrauben nicht entfernen! Bitte säubern Sie vorher die Fassung(en) von Schmutz und Grünspan.

### Bei Fremdfabrikaten gilt:

Für entstandene Schäden beim Demontieren der Brillenfassung(en) übernehmen wir keine Haftung. Bitte geben Sie bei jeder Fassung die Modelldaten an (Hersteller, Modell-Nr., Farb-Nr. und Größe). Brillenfassungen, die mit einem Nagel- oder Autolack nachbehandelt sind, können wir nicht beschichten.

### Rechtlicher Hinweis (Deutschland)

Das Medizinproduktegesetz verpflichtet den Augenoptiker (Sonderanfertiger), die von uns gegebenen Hinweise bezüglich der Produktinformation und Pflegehinweis zu beachten und auch an den Endverbraucher (Patient) weiterzugeben. Besonders ist darauf zu achten, dass unsere Produkte (Brillenfassungen) nicht mit Lösungsmitteln wie Spiritus, Aceton, Salmiaklösungen oder ähnliche Stoffe gereinigt werden. Dies kann zu allergischen oder toxischen Reaktionen führen.

Grundsätzlich ist der Augenoptiker (Sonderanfertiger) auch für die Beratung und Auswahl der „richtigen Brille“ für den Endkunden (Patient), bezüglich dessen allergischen Vorgeschichte verantwortlich. Bei schwangeren oder stillenden Frauen ist eine besondere Aufmerksamkeit notwendig. Bei der Verwendung von fremden oder falschen Ersatzteilen (z. B. Nasenstege), übernimmt Firma Binde Optik keine Haftung.

### Pflegehinweis für Brillengestelle & Patienteninformation:

Bitte achten Sie darauf, die Brillenfassungen nicht mit aggressiven chemischen Reinigungs- oder Desinfektionsmitteln in Kontakt zu bringen. Insbesondere sollten Aceton, Nitroverdünnung, Terpentinersatz, Waschbenzin, Essigessenz, Salmiaklösung und chlorhaltige Reinigungsmittel vermieden werden. Solche Substanzen können das Farbdesign der Brillenfassung, die biologischen Eigenschaften von Kunststofffassungen und die antiallergische Schutzbeschichtung von Metallfassungen angreifen.

### Cleaning of Optical Frames & Informations:

Please take care not to treat optical frames with aggressive chemical cleaning or disinfecting agents such as acetone, cellulose thinner, turpentine-like diluting agents, benzene, acetic acid, ammonium chloride or other chlorous chemicals. Such substances may damage the colour design or may adversely affect the biocompatibility of the plastic frames or may remove the allergy seal of metal frames.



## **Verkaufs-, Lieferungs- und Zahlungsbedingungen der Walter Binde Optik GmbH & Co. KG**

### **1. Allgemeine Bestimmungen**

Die nachstehenden Bedingungen werden sämtlichen Lieferungen und Leistungen zugrunde gelegt. Anders lautende Allgemeine Geschäftsbedingungen des Kunden, Abweichungen oder mündliche Nebenabreden sind nur verbindlich, wenn Sie entweder zwingendem Recht entsprechen oder von uns ausdrücklich schriftlich bestätigt worden sind. Der Vertrag bleibt auch im Fall der Unwirksamkeit einzelner Bestimmungen in seinen übrigen Teilen verbindlich. Etwaige unwirksame Bestimmungen sind von den Vertragspartnern im Rahmen des Zumutbaren nach Treu und Glauben durch solche Regelungen zu ersetzen, die dem wirtschaftlichen Zweck des Vertrages am besten gerecht werden, ohne dass dadurch der Vertragsinhalt wesentlich geändert wird. Das gleiche gilt, falls es an einer ausdrücklichen Regelung für einen regelungsbedürftigen Sachverhalt fehlt. Stellt das Festhalten an dem Vertrag eine unzumutbare Härte für eine Vertragspartei dar, so ist dieser unwirksam.

### **2. Vertrag und Umfang der Leistung**

Unsere Angebote sind freibleibend. Aufträge sind für uns erst verbindlich, wenn sie von uns schriftlich bestätigt worden sind. Fehlt eine schriftliche Bestätigung, wird diese durch die erteilte Rechnung oder Lieferschein ersetzt. Maßgeblich für den Umfang der geschuldeten Leistung ist allein unsere schriftliche Bestätigung. Katalogangaben, Abbildungen, Produktbeschreibungen, etc. sind lediglich als annähernd zu betrachten. Unwesentliche und/oder handelsübliche Abweichungen, wie z.B. auch solche im Rahmen der ständigen Produktverbesserung, die die Verwendbarkeit nicht beeinträchtigen und dem Kunden zumutbar sind, bleiben vorbehalten.

### **3. Preise und Zahlungsbedingungen**

Die Preise verstehen sich in Euro ab Werk Minden ausschließlich Verpackung zzgl. der jeweils geltenden Umsatzsteuer. Zahlungen haben innerhalb von 30 Tagen ab Rechnungsdatum ohne Abzug zu erfolgen, bei Zahlung innerhalb 10 Tagen ab Rechnungsdatum abzüglich 2 % Skonto. Die Zahlungen sind frei Zahlstelle des Lieferers zu leisten. Bei Verträgen mit Unternehmern können wir bei schuldhafter Überschreitung der Zahlungsfrist Verzugszinsen in Höhe von 8 % über dem jeweils geltenden Basiszinssatz nach § 247 BGB verlangen. Kommt der Kunde mit einem nicht unerheblichen Teil der Zahlung in Verzug oder gehen Schecks oder Wechsel zu Protest oder entfallen die Voraussetzungen für eine Kreditgewährung, so werden unsere sämtlichen Forderungen gegen ihn zur sofortigen Zahlung fällig. Dies gilt auch für ursprünglich gestundete Rechnungen sowie später fällige Wechsel oder Schecks. Verschlechtert sich die Vermögenslage des Kunden nach Vertragsabschluss erheblich oder wird eine bereits bestehende Kreditwürdigkeit erst nach Vertragsabschluss erkennbar, sind wir berechtigt, die noch nicht ausgeführten Lieferungen zu verweigern bzw. angemessene Vorauszahlungen oder Sicherheitsleistungen zu verlangen, wenn die Gegenleistung gefährdet ist. Der Kunde kann nur mit solchen Forderungen aufrechnen, die unbestritten oder rechtskräftig festgestellt sind. Ein Zurückbehaltungsrecht kommt für ihn nur insoweit in Betracht, als es auf Ansprüchen aus demselben Vertragsverhältnis beruht.

### **4. Lieferung**

Lieferfristen beginnen mit Vertragsschluss und können verbindlich nur schriftlich vereinbart werden. Die Lieferfrist verlängert sich angemessen, wenn der Käufer erforderliche und/oder vereinbarte Mitwirkungshandlungen verzögert oder unterläßt oder die vereinbarten Zahlungsbedingungen nicht einhält. Entsprechendes gilt bei Maßnahmen bei Eintritt unvorhergesehener Hindernisse, die außerhalb unserer Sphäre liegen, z. B. Lieferverzögerung eines Vorlieferanten, Verkehrs- und Betriebsstörungen, Werkstoff- oder Energiemangel, etc. Auch vom Kunden veranlaßte Änderungen der zu liefernden Ware führen zu einer angemessenen Verlängerung der Lieferfrist. Zu Teillieferungen sind wir berechtigt, soweit diese dem Kunden zumutbar sind. Bei einer länger andauernden Nichtverfügbarkeit der Leistung behalten wir uns den Rücktritt vom Vertrag vor.

### **5. Versand und Gefahrübergang**

Bei Versendung der Ware geht die Gefahr des zufälligen Untergangs und der zufälligen Verschlechterung der Sache auf den Kunden über, wenn die Ware an die den Transport ausführende Person übergeben wird oder wenn die Ware zwecks Versendung unser Lager verlassen hat. Soweit nichts anderes vereinbart ist, steht die Versandart, der Transportweg, etc. in unserem Ermessen. Kosten für abweichende Kundenwünsche gehen zu dessen Lasten. Eine zusätzliche Versicherung gegen Transportschäden erfolgt nur auf Anordnung und Kosten des Kunden. Bitte beachten: Unfreie Pakete und Päckchen werden von der Firma Binde Optik GmbH & Co. KG nicht angenommen.

## **6. Sachmängelhaftung**

Für die Verjährung von Ansprüchen wegen Sachmängel gelten die gesetzlichen Vorschriften. Liegen Mängel vor, kann der Kunde primär Nacherfüllung gemäß § 439 BGB verlangen. Wir sind berechtigt, zwischen der Beseitigung des Mangels und der Lieferung einer mangelfreien Sache zu wählen. Bitte beachten: Gewährleistungsansprüche sind zunächst auf zweimaliger Nacherfüllung beschränkt, wobei die Firma Binde Optik GmbH & Co. KG Kenntnis von der Nacherfüllung haben muss. Bei Fehlschlägen der Nacherfüllung besteht ein Anspruch auf Rücktritt vom Kaufvertrag. Mängelansprüche bestehen nicht bei einer unerheblichen Abweichung von der vereinbarten Beschaffenheit, bei einer unerheblichen Beeinträchtigung der Brauchbarkeit, bei natürlicher Abnutzung oder Schäden, die nach dem Gefahrübergang infolge fehlerhafter oder nachlässiger Behandlung, übermäßiger Beanspruchung, unsachgemäßem Gebrauch, mangelnder Pflege, etc. entstehen. Werden vom Kunden oder von Dritten unsachgemäß Änderungen oder Bearbeitungen vorgenommen, so bestehen für diese und die daraus entstehenden Folgen ebenfalls keine Mängelansprüche. Wir haften nach den gesetzlichen Bestimmungen auf Schadensersatz, sofern der Kunde Ansprüche geltend macht, die auf Arglist, Vorsatz oder grober Fahrlässigkeit unsererseits, auf Verletzung des Lebens, des Körpers oder der Gesundheit oder auf der Verletzung vertragswesentlicher Pflichten beruhen. Wird uns keine vorsätzliche oder grob fahrlässige Vertragsverletzung angelastet, haften wir nur auf den Ersatz des typischen vorhersehbaren Schadens. Eine Haftung für Schäden, die nicht am Liefergegenstand entstanden sind, scheidet aus, es sei denn, es handelt sich um Verletzungen des Lebens, des Körpers oder der Gesundheit, die aus einer von uns begangenen fahrlässigen Pflichtverletzung oder einer vorsätzlichen oder fahrlässigen Pflichtverletzung unseres gesetzlichen Vertreters oder Erfüllungsgehilfen beruhen. Im Übrigen ist die Schadensersatzhaftung ausgeschlossen.

## **7. Eigentumsvorbehalt**

Wir behalten uns das Eigentum an sämtlichen gelieferten Waren bis zur vollständigen Bezahlung vor. Im Rechtsverkehr mit Kaufleuten gilt der Eigentumsvorbehalt auch, bis sämtliche, auch künftige und bedingte Forderungen aus der Geschäftsverbindung erfüllt sind. Zur Weiterveräußerung ist der Kunde nur im ordnungsgemäßen Geschäftsgang berechtigt, wobei er seine Forderung aus der Weiterveräußerung bereits jetzt an uns abtritt. Wir nehmen die Abtretung an. Zur Einziehung dieser Forderung bleibt der Kunde auch nach der Abtretung ermächtigt. Unsere Befugnis, die Forderung selbst einzuziehen, bleibt hiervon unberührt. Wir verpflichten uns, die Forderung nicht selbst einzuziehen, solange der Kunde seinen Zahlungsverpflichtungen vertragsgemäß nachkommt. Der Kunde ist nicht berechtigt, unter Eigentumsvorbehalt stehende Ware zu verpfänden oder zur Sicherheit zu übereignen. Einwirkungen Dritter auf diese Waren, insbesondere Pfändungen, sind uns unverzüglich mitzuteilen. Die Befugnis zur Weiterveräußerung kann von uns widerrufen werden, falls der Kunde seinen Verpflichtungen aus dem Vertrag nicht ordnungsgemäß nachkommt. Auf Verlangen des Kunden sind wir verpflichtet, eingeräumte Sicherheiten nach unserer Wahl freizugeben, soweit deren Wert unsere Forderungen um mehr als 10 % übersteigt.

## **8. Rückgriff des Unternehmers**

Verkauft der Kunde die neu hergestellte Ware im Rahmen seines gewerblichen Betriebes an einen Verbraucher weiter und musste er diese Ware als Folge ihrer Mangelhaftigkeit zurücknehmen oder minderte der Verbraucher den Kaufpreis, so bedarf es für die Geltendmachung der Mängelansprüche des Kunden uns gegenüber keiner Fristsetzung. Der Kunde kann in dem Fall von uns Ersatz der Aufwendungen verlangen, die er im Verhältnis zum Verbraucher zu tragen hatte, wenn der vom Verbraucher geltend gemachte Mangel bereits bei Übergang der Gefahr auf den Kunden vorhanden war. Im Rahmen dieses Unternehmerückgriffs hat der Kunde keinen Anspruch auf Schadensersatz.

## **9. Sonstige Bestimmungen**

Rücksendungen aus Auswahlendungen werden nur innerhalb von 14 Tagen akzeptiert. Die Ware muss original verpackt und in einem einwandfreien Zustand sein. Produktänderungen (Preise, Modelle, Farben) sind jederzeit über die Homepage ([www.Binde-Optik.de](http://www.Binde-Optik.de)) abrufbar. Produktinformationen bezüglich Material und Verträglichkeit werden grundsätzlich nur schriftlich beantwortet. Bitte beachten: Unfreie Pakete und Päckchen werden von der Firma Binde Optik GmbH & Co. KG nicht angenommen.

## **10. Abschließende Bestimmungen**

Ist der Kunde Kaufmann, juristische Person des öffentlichen Rechts oder ein öffentlichrechtliches Sondervermögen, ist Gerichtsstand für alle sich aus dem Vertragsverhältnis ergebenden Streitigkeiten der für unseren Firmensitz zuständige Gerichtsort. Erfüllungsort ist Minden/Westfalen. Auf alle Verträge findet deutsches Recht Anwendung. „Verbraucher“ im Sinne dieser Bestimmungen ist gemäß § 13 BGB jede natürliche Person, die das Geschäft zu einem Zweck abschließt, der weder ihrer gewerblichen noch ihrer selbstständigen beruflichen Tätigkeit zugerechnet werden kann.

Sitz der KG: Minden, HRA 3533 Bad Oeynhausen

Pers. haftende Gesellschafterin: Binde-Beteiligungs-GmbH Minden, HRB 5095 Bad Oeynhausen,

Geschäftsführer: Jörn Binde, Walter Koenemann

## » Inhalt nach Modellnummern

| Art.-Nr. | Seite | Art.-Nr. | Seite | Art.-Nr. | Seite | Art.-Nr. | Seite | Art.-Nr. | Seite | Art.-Nr. | Seite |
|----------|-------|----------|-------|----------|-------|----------|-------|----------|-------|----------|-------|
| 511      | 58    | 2519     | 82    | 5428     | 78    | 7701     | 91    | 7897     | 71    | 8148     | 40    |
| 512      | 58    | 2522     | 82    | 5429     | 78    | 7742     | 91    | 7898     | 71    | 8149     | 40    |
| 515      | 58    | 2528     | 82    | 5430     | 78    | 7743     | 90    | 7899     | 71    | 8150     | 39    |
| 519      | 58    | 2529     | 82    | 5431     | 15    | 7746     | 45    | 7900     | 70    | 8151     | 39    |
| 520      | 57    | 2530     | 81    | 5432     | 15    | 7752     | 45    | 7901     | 70    | 8152     | 39    |
| 521      | 57    | 2531     | 81    | 5434     | 15    | 7753     | 44    | 7902     | 70    | 8153     | 9     |
| 523      | 57    | 2532     | 81    | 5435     | 15    | 7759     | 44    | 7903     | 70    | 8155     | 9     |
| 524      | 57    | 2877     | 50    | 5436     | 14    | 7772     | 30    | 7904     | 22    | 8156     | 9     |
| 526      | 56    | 2880     | 47    | 5437     | 14    | 7788     | 44    | 7905     | 22    | 8158     | 9     |
| 528      | 56    | 2881     | 47    | 5439     | 14    | 7792     | 29    | 7906     | 22    | 8159     | 8     |
| 529      | 56    | 2884     | 47    | 5440     | 14    | 7798     | 44    | 7907     | 21    | 8160     | 8     |
| 530      | 56    | 2887     | 47    | 5441     | 13    | 7800     | 29    | 7908     | 21    | 8161     | 8     |
| 531      | 55    | 2888     | 49    | 5442     | 78    | 7803     | 74    | 7909     | 21    | 8162     | 68    |
| 532      | 55    | 2889     | 49    | 5445     | 77    | 7807     | 73    | 7910     | 21    | 8163     | 67    |
| 533      | 55    | 2891     | 46    | 6129     | 45    | 7808     | 29    | 7911     | 20    | 8165     | 67    |
| 534      | 55    | 2894     | 46    | 6140     | 77    | 7815     | 29    | 7912     | 20    | 8166     | 67    |
| 535      | 54    | 2895     | 46    | 6142     | 36    | 7825     | 73    | 7913     | 20    | 8167     | 84    |
| 536      | 54    | 2896     | 46    | 6150     | 36    | 7829     | 73    | 7914     | 20    | 8168     | 8     |
| 539      | 54    | 2897     | 49    | 6152     | 77    | 7832     | 28    | 7915     | 19    | 8169     | 7     |
| 540      | 54    | 2899     | 49    | 6153     | 77    | 7833     | 28    | 7916     | 19    | 8170     | 7     |
| 599      | 59    | 2900     | 48    | 6159     | 86    | 7834     | 28    | 7917     | 19    | 8172     | 7     |
| 1041     | 90    | 2901     | 48    | 6160     | 86    | 7836     | 28    | 7918     | 19    | 8173     | 7     |
| 1052     | 90    | 2902     | 48    | 6161     | 36    | 7838     | 27    | 7919     | 18    | 8174     | 6     |
| 1072     | 89    | 2903     | 48    | 6162     | 35    | 7839     | 27    | 7920     | 18    | 8175     | 6     |
| 1112     | 92    | 4251     | 53    | 6163     | 35    | 7841     | 27    | 7923     | 18    | 8177     | 6     |
| 1114     | 89    | 4257     | 53    | 6164     | 35    | 7842     | 27    | 7924     | 42    | 8178     | 6     |
| 1129     | 92    | 4266     | 53    | 6165     | 35    | 7846     | 73    | 7925     | 42    | 8179     | 5     |
| 1139     | 65    | 4267     | 53    | 6166     | 34    | 7848     | 86    | 7926     | 18    | 8180     | 5     |
| 1143     | 64    | 4268     | 52    | 6167     | 34    | 7849     | 85    | 7928     | 69    | 8181     | 5     |
| 1147     | 64    | 4269     | 52    | 6168     | 34    | 7850     | 85    | 7929     | 69    | 8182     | 67    |
| 1149     | 89    | 4270     | 52    | 6169     | 34    | 7852     | 26    | 7930     | 69    | 8183     | 66    |
| 1150     | 89    | 4271     | 52    | 6170     | 33    | 7853     | 26    | 8033     | 42    | 8184     | 5     |
| 1152     | 88    | 4272     | 51    | 6174     | 76    | 7856     | 26    | 8034     | 41    | 8185     | 4     |
| 1155     | 64    | 4273     | 51    | 6175     | 76    | 7857     | 26    | 8049     | 41    | 8186     | 39    |
| 1162     | 64    | 4277     | 51    | 6176     | 76    | 7858     | 25    | 8050     | 41    | 8187     | 38    |
| 1163     | 63    | 4278     | 51    | 6178     | 76    | 7859     | 25    | 8063     | 41    | 8188     | 38    |
| 1164     | 63    | 4279     | 50    | 6179     | 75    | 7860     | 43    | 8102     | 40    | 8189     | 38    |
| 1165     | 63    | 4280     | 50    | 6180     | 75    | 7861     | 43    | 8106     | 40    | 8190     | 38    |
| 1166     | 88    | 5389     | 17    | 6181     | 33    | 7862     | 43    | 8111     | 13    | 8191     | 4     |
| 1167     | 63    | 5401     | 81    | 6182     | 33    | 7865     | 85    | 8113     | 69    | 8192     | 4     |
| 1168     | 62    | 5402     | 80    | 6183     | 33    | 7866     | 85    | 8115     | 68    | 8194     | 4     |
| 1169     | 62    | 5403     | 80    | 6184     | 32    | 7877     | 25    | 8116     | 68    | 8195     | 3     |
| 1170     | 62    | 5404     | 87    | 6185     | 32    | 7878     | 25    | 8120     | 68    | 8196     | 3     |
| 1171     | 88    | 5405     | 87    | 6186     | 32    | 7879     | 24    | 8121     | 13    | 8197     | 3     |
| 1172     | 88    | 5406     | 17    | 6187     | 32    | 7880     | 24    | 8122     | 13    | 8198     | 3     |
| 1173     | 62    | 5410     | 17    | 6188     | 31    | 7881     | 24    | 8126     | 84    | 8199     | 66    |
| 1174     | 61    | 5411     | 16    | 6189     | 31    | 7882     | 24    | 8127     | 84    | 8200     | 66    |
| 1175     | 61    | 5413     | 16    | 6190     | 31    | 7883     | 23    | 8128     | 12    | 8201     | 66    |
| 1176     | 61    | 5414     | 16    | 6191     | 31    | 7884     | 43    | 8131     | 12    | 8951     | 90    |
| 1177     | 61    | 5416     | 80    | 6192     | 30    | 7886     | 23    | 8135     | 12    |          |       |
| 1178     | 60    | 5418     | 80    | 6193     | 30    | 7887     | 23    | 8136     | 12    |          |       |
| 1179     | 60    | 5419     | 87    | 6194     | 30    | 7888     | 23    | 8138     | 11    |          |       |
| 1180     | 60    | 5420     | 87    | 6196     | 75    | 7890     | 84    | 8139     | 11    |          |       |
| 1181     | 60    | 5422     | 86    | 6197     | 75    | 7891     | 72    | 8140     | 11    |          |       |
| 2498     | 83    | 5423     | 79    | 6198     | 74    | 7892     | 72    | 8141     | 11    |          |       |
| 2504     | 92    | 5424     | 16    | 6202     | 74    | 7893     | 72    | 8142     | 10    |          |       |
| 2511     | 83    | 5425     | 79    | 6203     | 74    | 7894     | 72    | 8143     | 10    |          |       |
| 2517     | 83    | 5426     | 79    | 7699     | 91    | 7895     | 22    | 8145     | 10    |          |       |
| 2518     | 83    | 5427     | 79    | 7700     | 91    | 7896     | 71    | 8147     | 10    |          |       |













**Walter Binde Optik GmbH & Co. KG**

Königstraße 134b | D-32427 Minden  
Postfach 2160 | D-32378 Minden

Auftragsannahme: +49 (0)5 71 / 2 80 13  
                          +49 (0)5 71 / 2 80 14  
Telefax:              +49 (0)5 71 / 8 51 11  
Nach Geschäftsschluss Anrufbeantworter

Bestellung:          bestellung@binde-optik.de  
Buchhaltung:       fibu@binde-optik.de

**[www.binde-optik.de](http://www.binde-optik.de)**