

**FASSUNGS-
KATALOG**

Frühjahr/Sommer 2018



WWW.BINDE-OPTIK.DE

Katalog ab 1. Januar 2018

Es gelten die Verkaufs-, Lieferungs- und Zahlungsbedingungen der Walter Binde GmbH & Co. KG

Walter Binde Optik GmbH & Co. KG

Königstraße 134b | D-32427 Minden
Postfach 2160 | D-32378 Minden

Auftragsannahme: +49 (0)5 71 / 2 80 13

+49 (0)5 71 / 2 80 14

Telefax: +49 (0)5 71 / 8 51 11

Nach Geschäftsschluss Anrufbeantworter

Bestellung: bestellung@binde-optik.de

Buchhaltung: fibu@binde-optik.de

www.binde-optik.de

| | |
|--|---------|
| › LOOK & FEEL Damen Metall- und Cellfassungen | 3 – 16 |
| › LOOK & FEEL Herren Metall-, Cell-, Beflex- und Clip-on-Fassungen | 17 – 34 |
| › women Damen Metallfassungen | 35 – 38 |
| › men Herren Metall- und Beflexfassungen | 39 – 41 |
| › Jump Up und Jump Up Teens | 42 – 43 |
| › Kids One | 44 – 47 |
| › Skylight Titan | 48 – 52 |
| › Readers | 53 – 56 |
| › Start Up – Premium, Classic, Fashion, Readers, Basics | 57 – 85 |
| › Werbung/Marketing | 86 – 87 |
| › Werkstattbedarf | 88 – 89 |
| › Zertifikat zur Biokompatibilität | 90 |
| › Allergieschutzbeschichtung, Rechtlicher Hinweis, Pflegehinweis | 91 |
| › AGB | 92 – 93 |
| › Inhalt nach Modellnummern | 94 |
| › Notizen | 96 |

| Farb-Nr. | Farbe / Color |
|----------|---|
| 01 | silber / silver |
| 02 | gold / gold |
| 03 | bi-color / gold & silver |
| 04 | weiss / white |
| 05 | rosa / rose, salmon-coloured, pink |
| 06 | gelb / yellow |
| 07 | hellblau / light blue |
| 08 | blau / blue |
| 09 | orange, hellrot / orange, light red |
| 10 | rot, bordeaux / red, bordeaux |
| 11 | hellbraun, havanna / light brown, havanna |
| 12 | braun / brown |
| 13 | hellgrau / light grey |
| 14 | silberantik, gun, grau / silverantik, gun, grey, anthracite |
| 15 | grün / green |
| 16 | schwarz / black |
| 17 | lila, flieder / lilac |

Premium-Publikation Printkatalog.

Warum Binde Optik aufwendig Printkataloge produziert.



In der Optik-Branche werden Printkataloge immer seltener. Binde Optik setzt nach wie vor darauf. Mit hohem Anspruch und enorm großem Aufwand. Der Grund: Für die Augenoptik-Händler hat er einen unschätzbaren Nutzen. Dank Printkatalog können sie sich schnell, einfach und komfortabel informieren – inklusive unkomplizierter Order per Fax/Telefon. Eine wertige Publikation – als besondere Wertschätzung des Kunden und als Anspruch an sich selbst.

Jedes Jahr versendet Binde Optik rund 11.000 Kataloge an Augenoptik-Händler in ganz Deutschland: den 100-seitigen Hauptkatalog „Fassungskatalog Frühjahr/Sommer“ zu Jahresbeginn sowie den etwas kleineren Ergänzungskatalog Herbst/Winter im August/September. Auflage jeweils 5.500 Stück. Der personelle Aufwand dieses Projekts, aber auch Qualität und Anspruch an die Print-Publikationen sind hoch.

In den beiden Katalogen pro Jahr müssen zusammen ca. 150 neue Modelle in je drei Farben vorgestellt werden. Hier ist u.a. der international tätige Profi-Werbefotograf Volker Bültmann in seinem Element, der seit über zehn Jahren für Binde Optik fotografiert. Er setzt die neuen Modelle optimal in Szene. Dabei gelten fest definierte Standards, etwa bei Kameraaufbau, Positionierung und Beleuchtung. Denn: es soll immer exakt identisches Bildmaterial vorliegen, damit eine optimale Vergleichbarkeit der Produkte gegeben ist. Alle Fassungen müssen perfekt ausgeleuchtet sein, um kleinste Details exzellent zu präsentieren und insgesamt eine gleichbleibend

sehr hohe Bildqualität zu garantieren. Das leistet Fotograf Bültmann in einzigartiger Weise. Die zentrale Steuerung des Projekts liegt in der Verantwortung der IKON Design- & Werbeagentur aus Minden. Diese betreut Jahr für Jahr die Katalogarbeit mit Fachkompetenz & Manpower, übernimmt Planung, Bildauswahl, Datenverwaltung, Konzeption, Gestaltung und Druckabwicklung. So müssen die Aufnahmen der Fassungen in der Publikation freigestellt und platziert, sämtliche Produktdaten der Modelle übersichtlich dargestellt und der gesamte Katalog professionell layoutet werden. IKON überwacht zudem Druckabnahme, Verarbeitung/Veredelung, Qualitätsmanagement sowie Versand. Rund 12 Personen sind insgesamt in das Projekt involviert – angefangen bei den Mitarbeitern von IKON und Binde Optik über Fotograf und Texter bis hin zu den Druck-Profis. Von der ersten Besprechung bis zum Versand vergehen etwa zwei Monate – dann kann der Augenoptiker den schon ersehnten Katalog bzw. Magalog studieren. Magalog – das ist der Fachterminus für eine Mischung aus Magazin und Katalog. So ist der Hauptkatalog zum Jahresanfang Bestell-Medium und Magalog zugleich. Features zu Themen wie Produktentwicklung, Design oder innovative Materialien von Fassungen bieten den Kunden somit Mehrwert. Qualität und Hochwertigkeit sind nicht nur ein Anspruch, der für die Fassungen von Binde Optik gilt, sondern auch für Marketing und Bestell-Service. Professionelle Fotos, gute Texte, erstklassige Aufbereitung aller Produktdaten, hochwertige Druck- und Veredelungsqualität – dafür stehen die Kataloge von Binde Optik. Und der Augenoptiker kann damit schnell, einfach und direkt via Fax/Telefon Modelle ordern. Bei der Papierauswahl bzw. Veredelung setzt IKON auf Dispersionslack glänzend. Der Umschlag mit wertiger PUR-Klebebindung wird glanzfolienkaschiert und mit einer gestanzten Abheftvorrichtung ausgestattet – anstatt mit simpler Nadelheftung. Tolle Optik & Haptik! Thomas Burow, Leiter Entwicklung und Marketing/Vertrieb bei Binde Optik: „Unsere Kunden legen Wert auf diesen Printkatalog. Sie verwenden ihn oft im Geschäft bei der täglichen Arbeit zur schnellen Produktübersicht, für unkompliziertes Bestellen und um sich Anregungen zu holen!“ Die Wichtigkeit des Printkatalogs wird durch die Rückmeldungen vieler Kunden bestätigt: „Bitte schaffen Sie Ihren Printkatalog nicht wie Ihre Wettbewerber ab – wir arbeiten sehr häufig damit. Er ist für uns von großem Nutzen!“

» Look & Feel Damen Metall- und Cellfassungen

LOOK & FEEL **8235**

NEU

LOOK & FEEL
EYEWEAR COLLECTION



- Größen 52-17
Farben 08
10
12
52
17
135
39
14

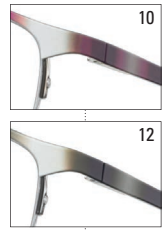

Farbe 08 Edelstahl, Federscharnier

STAINLESS STEEL
premium selection

LOOK & FEEL **8234**

NEU

LOOK & FEEL
EYEWEAR COLLECTION



- Größen 53-16
Farben 08
10
16
53
16
135
38
16

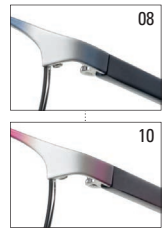

Farbe 16 Edelstahl, Kunststoffbügel

STAINLESS STEEL
premium selection

LOOK & FEEL **8232**

NEU

LOOK & FEEL
EYEWEAR COLLECTION



- Größen 54-17
Farben 08
10
12
54
17
135
36
17

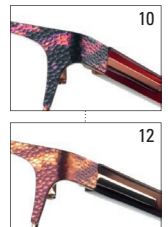

Farbe 08 Edelstahl, Federscharnier, Kunststoffbügel

STAINLESS STEEL
premium selection

LOOK & FEEL **8231**

NEU

LOOK & FEEL
EYEWEAR COLLECTION



- Größen 52-16
Farben 10
12
16
52
16
135
34
17



Farbe 16 Edelstahl, Federscharnier, Kunststoffbügel

STAINLESS STEEL
premium selection

» Look & Feel Damen Metall- und Cellfassungen

LOOK & FEEL **8229**

NEU

LOOK & FEEL
EYEWEAR COLLECTION



- Größen 52-17
Farben 04
10
12
52
17
135
35
16

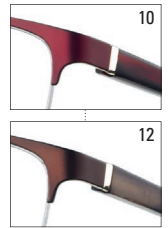

Farbe 04 Edelstahl, Federscharnier, Kunststoffbügel

STAINLESS STEEL
premium selection

LOOK & FEEL **8228**

NEU

LOOK & FEEL
EYEWEAR COLLECTION



- Größen 53-16
Farben 08
12
16
53
16
135
36
16

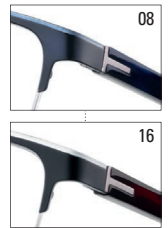

Farbe 12 Edelstahl, Federscharnier, Kunststoffbügel

STAINLESS STEEL
premium selection

LOOK & FEEL **8227**

NEU

LOOK & FEEL
EYEWEAR COLLECTION



- Größen 53-16
Farben 08
12
16
17
53
16
135
36
17

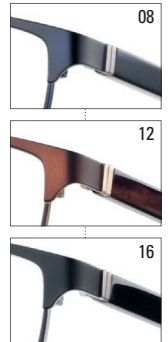

Farbe 17 Edelstahl, Federscharnier, Kunststoffbügel

STAINLESS STEEL
premium selection

LOOK & FEEL **8226**

NEU

LOOK & FEEL
EYEWEAR COLLECTION



- Größen 53-16
Farben 08
12
15
17
53
16
135
39
14

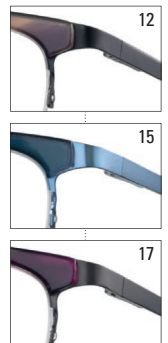

Farbe 08 Edelstahl, Federscharnier (Kombibrille)

STAINLESS STEEL
premium selection

» Look & Feel Damen Metall- und Cellfassungen

LOOK & FEEL **8225**

NEU

LOOK & FEEL
EYEWEAR COLLECTION



STAINLESS STEEL
premium selection

Größen 52-17

Farben 08

12

15

16



52

17

135

39

12



08



12



16

Farbe 15 Edelstahl, Kombibrille

LOOK & FEEL **8214**

LOOK & FEEL
EYEWEAR COLLECTION



STAINLESS STEEL
premium selection

Größen 48-19

Farben 10

12

16



48

19

135

35

13



10



12

Farbe 16 Edelstahl, Kunststoffbügel

LOOK & FEEL **8213**

LOOK & FEEL
EYEWEAR COLLECTION



STAINLESS STEEL
premium selection

Größen 48-18

Farben 08

12

15

16



48

18

135

40

13



08



15



16

Farbe 12 Edelstahl, Kunststoffbügel

LOOK & FEEL **8212**

LOOK & FEEL
EYEWEAR COLLECTION



STAINLESS STEEL
premium selection

Größen 56-17

Farben 08

10

16



56

17

135

40

16



08



16

Farbe 10 Edelstahl, Federscharnier, Kunststoffbügel

» Look & Feel Damen Metall- und Cellfassungen

LOOK & FEEL **8203**

LOOK & FEEL
EYEWEAR COLLECTION



STAINLESS STEEL
premium selection

- Größen 54-17
Farben 10
12
16
54
17
135
34
16

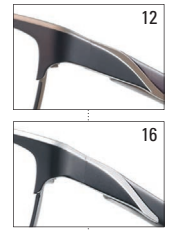

Farbe 10 Edelstahl, Federscharnier, Kunststoffbügel

LOOK & FEEL **8202**

LOOK & FEEL
EYEWEAR COLLECTION



STAINLESS STEEL
premium selection

- Größen 55-17
Farben 10
12
16
55
17
135
37
18

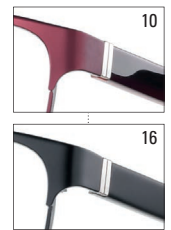

Farbe 12 Edelstahl, Federscharnier, Kunststoffbügel

LOOK & FEEL **8197**

LOOK & FEEL
EYEWEAR COLLECTION



STAINLESS STEEL
premium selection

- Größen 53-16
Farben 08
10
12
53
16
135
36
16

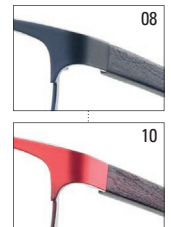

Farbe 12 Edelstahl, Federscharnier, Kunststoffbügel

LOOK & FEEL **8195**

LOOK & FEEL
EYEWEAR COLLECTION



STAINLESS STEEL
premium selection

- Größen 54-16
Farben 10
12
17
54
16
135
33
11

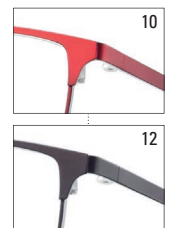

Farbe 17 Edelstahl

» Look & Feel Damen Metall- und Cellfassungen

LOOK & FEEL **8194**

LOOK & FEEL
EYEWEAR COLLECTION



- Größen 54-16
Farben 08
10
12
54
16
135
38
12



Farbe 08 Edelstahl

STAINLESS STEEL
premium selection

LOOK & FEEL **8192**

LOOK & FEEL
EYEWEAR COLLECTION



- Größen 49-16
Farben 10
12
16
49
16
130
33
14

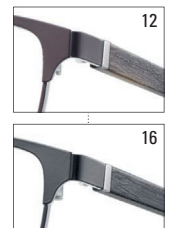

Farbe 10 Edelstahl, Federscharnier, Kunststoffbügel

STAINLESS STEEL
premium selection

LOOK & FEEL **8191**

LOOK & FEEL
EYEWEAR COLLECTION



- Größen 53-16
Farben 10
12
16
53
16
135
36
11

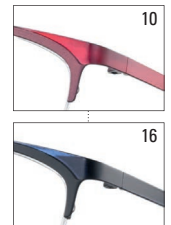

Farbe 12 Edelstahl

STAINLESS STEEL
premium selection

LOOK & FEEL **8179**

LOOK & FEEL
EYEWEAR COLLECTION



- Größen 54-17
Farben 10
15
54
17
135
36
16



Farbe 15 Edelstahl, Federscharnier, Kunststoffbügel

STAINLESS STEEL
premium selection

» Look & Feel Damen Metall- und Cellfassungen

LOOK & FEEL **8178**

LOOK & FEEL
EYEWEAR COLLECTION



- Größen 53-17
Farben 10
15
16
53
17
135
37
12

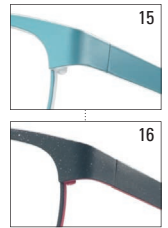

Farbe 10 Edelstahl, Federscharnier

STAINLESS STEEL
premium selection

LOOK & FEEL **8177**

LOOK & FEEL
EYEWEAR COLLECTION



- Größen 52-17
Farben 08
10
12
52
17
135
37
11

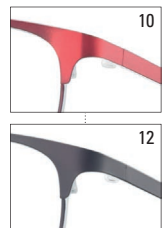

Farbe 08 Edelstahl

STAINLESS STEEL
premium selection

LOOK & FEEL **8175**

LOOK & FEEL
EYEWEAR COLLECTION



- Größen 52-16
Farben 10
15
52
16
135
35
16



Farbe 15 Edelstahl, Federscharnier, Kunststoffbügel

STAINLESS STEEL
premium selection

LOOK & FEEL **8174**

LOOK & FEEL
EYEWEAR COLLECTION



- Größen 55-16
Farben 10
12
16
55
16
135
35
19

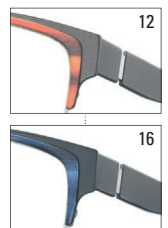

Farbe 10 Edelstahl, Federscharnier

STAINLESS STEEL
premium selection

› Look & Feel Damen Metall- und Cellfassungen

LOOK & FEEL **8172**

LOOK & FEEL
EYEWEAR COLLECTION



- Größen 54-16
Farben 10
12
16
54
16
135
35
15

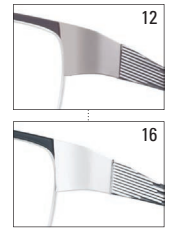

Farbe 10 Edelstahl, Federscharnier

STAINLESS STEEL
premium selection

LOOK & FEEL **8170**

LOOK & FEEL
EYEWEAR COLLECTION



- Größen 54-16
Farben 14
16
54
16
135
38
13



Farbe 14 Edelstahl

STAINLESS STEEL
premium selection

LOOK & FEEL **8168**

LOOK & FEEL
EYEWEAR COLLECTION



- Größen 54-16
Farben 10
12
16
54
16
135
37
15

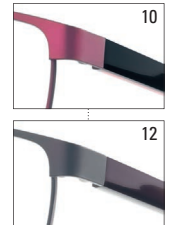

Farbe 16 Edelstahl, Kunststoffbügel

STAINLESS STEEL
premium selection

LOOK & FEEL **8160**

LOOK & FEEL
EYEWEAR COLLECTION



- Größen 56-16
Farben 10
12
16
56
16
140
36
20

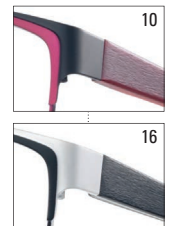

Farbe 12 Edelstahl, Federscharnier, Kunststoffbügel

STAINLESS STEEL
premium selection

» Look & Feel Damen Metall- und Cellfassungen

LOOK & FEEL **8159**

LOOK & FEEL
EYEWEAR COLLECTION



- Größen 53-17
Farben 08
12
16
53
17
140
37
15

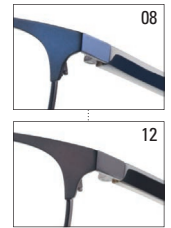

Farbe 16 Edelstahl, Kunststoffbügel

STAINLESS STEEL
premium selection

LOOK & FEEL **8158**

LOOK & FEEL
EYEWEAR COLLECTION



- Größen 52-17
Farben 12
14
52
17
135
37
18



Farbe 12 Edelstahl, Federscharnier, Kunststoffbügel

STAINLESS STEEL
premium selection

LOOK & FEEL **8156**

LOOK & FEEL
EYEWEAR COLLECTION



- Größen 52-16
Farben 10
16
17
52
16
135
35
15

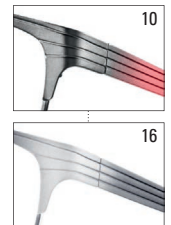

Farbe 17 Edelstahl, Federscharnier

STAINLESS STEEL
premium selection

LOOK & FEEL **8155**

LOOK & FEEL
EYEWEAR COLLECTION



- Größen 53-17
Farben 08
10
16
53
17
135
35
16

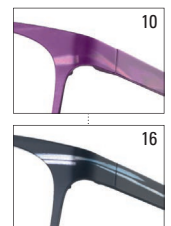

Farbe 08 Edelstahl, Federscharnier

STAINLESS STEEL
premium selection

TOP PREIS LEISTUNG

› Look & Feel Damen Metall- und Cellfassungen

LOOK & FEEL **8153**



LOOK & FEEL
EYEWEAR COLLECTION

- Größen 53-17
Farben 08
10
16
53
17
135
37
15

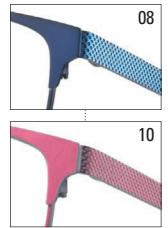

Farbe 16 Edelstahl, Federscharnier

STAINLESS STEEL
premium selection

LOOK & FEEL **8147**



LOOK & FEEL
EYEWEAR COLLECTION

- Größen 53-15
Farben 12
14
16
53
15
135
34
15

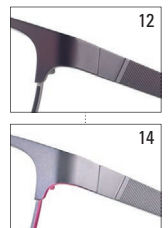

Farbe 16 Edelstahl, Federscharnier

STAINLESS STEEL
premium selection

LOOK & FEEL **8140**



LOOK & FEEL
EYEWEAR COLLECTION

- Größen 52-17
Farben 08
16
52
17
135
36
16



Farbe 16 Edelstahl, Federscharnier

STAINLESS STEEL
premium selection

LOOK & FEEL **8139**



LOOK & FEEL
EYEWEAR COLLECTION

- Größen 52-17
Farben 12
14
17
52
17
135
34
16

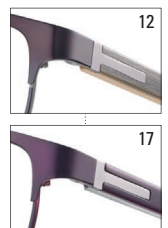

Farbe 14 Edelstahl, Federscharnier, Kunststoffbügel

STAINLESS STEEL
premium selection

» Look & Feel Damen Metall- und Cellfassungen

LOOK & FEEL **5470**

NEU



LOOK & FEEL
EYEWEAR COLLECTION

Größen 54-16

Farben 12

15

16

17

54

16

135

38

14



12

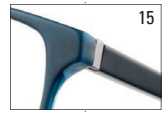

15



16

Farbe 17 Zelluloseacetat, Federscharnier

XTRA LIGHT ACETATE
premium selection

LOOK & FEEL **5469**

NEU



LOOK & FEEL
EYEWEAR COLLECTION

Größen 51-17

Farben 08

11

12

16

51

17

140

41

12



08

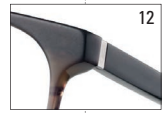

12



16

Farbe 11 Zelluloseacetat

XTRA LIGHT ACETATE
premium selection

LOOK & FEEL **5468**

NEU



LOOK & FEEL
EYEWEAR COLLECTION

Größen 52-14

Farben 08

10

15

52

14

135

38

11



10



15

Farbe 08 Zelluloseacetat, Metallbügel

XTRA LIGHT ACETATE
premium selection

LOOK & FEEL **5467**

NEU



LOOK & FEEL
EYEWEAR COLLECTION

Größen 52-12

Farben 11

12

14

52

12

135

37

11



11

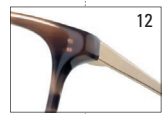

12

Farbe 14 Zelluloseacetat, Metallbügel

XTRA LIGHT ACETATE
premium selection

» Look & Feel Damen Metall- und Cellfassungen

LOOK & FEEL **5466**

NEU

LOOK & FEEL
EYEWEAR COLLECTION



XTRA LIGHT ACETATE
premium selection

Farbe 12 Zelluloseacetat, Metallbügel

Größen 48-19

Farben

05

08

12

15

48

19

140

37

12



LOOK & FEEL **5465**

LOOK & FEEL
EYEWEAR COLLECTION



XTRA LIGHT ACETATE
premium selection

Farbe 15 Zelluloseacetat, Metallbügel

Größen 53-16

Farben

11

12

15

16

53

16

140

38

10

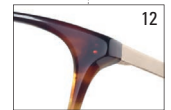

LOOK & FEEL **5464**

LOOK & FEEL
EYEWEAR COLLECTION



XTRA LIGHT ACETATE
premium selection

Farbe 12 Zelluloseacetat, Metallbügel

Größen 52-18

Farben

08

12

16

52

18

140

43

11



LOOK & FEEL **5463**

LOOK & FEEL
EYEWEAR COLLECTION



XTRA LIGHT ACETATE
premium selection

Farbe 12 Zelluloseacetat, Metallbügel

Größen 53-19

Farben

11

12

16

53

19

140

42

11



» Look & Feel Damen Metall- und Cellfassungen

LOOK & FEEL **5461**

LOOK & FEEL
EYEWEAR COLLECTION



XTRA LIGHT ACETATE
premium selection

- Größen 48-18
Farben 08
15
16
48
18
140
38
10

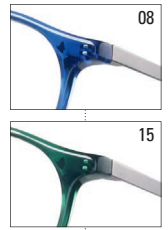

Farbe 16 Zelluloseacetat, Metallbügel

LOOK & FEEL **5441**

LOOK & FEEL
EYEWEAR COLLECTION



XTRA LIGHT ACETATE
premium selection

- Größen 54-16
Farben 10
12
16
54
16
135
39
11

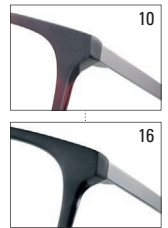

Farbe 12 Zelluloseacetat, Metallbügel

LOOK & FEEL **5440**

LOOK & FEEL
EYEWEAR COLLECTION



XTRA LIGHT ACETATE
premium selection

- Größen 53-12
Farben 10
12
16
53
12
135
35
14

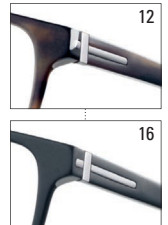

Farbe 10 Zelluloseacetat

LOOK & FEEL **5439**

LOOK & FEEL
EYEWEAR COLLECTION



XTRA LIGHT ACETATE
premium selection

- Größen 55-15
Farben 11
12
16
55
15
135
39
14

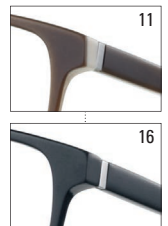

Farbe 12 Zelluloseacetat, Federscharnier

» Look & Feel Damen Metall- und Cellfassungen

LOOK & FEEL **5437**



LOOK & FEEL
EYEWEAR COLLECTION

- Größen 48-18
Farben 10
12
16
48
18
135
38
10

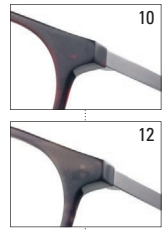

Farbe 16 Zelluloseacetat, Metallbügel

XTRA LIGHT ACETATE
premium selection

LOOK & FEEL **5435**



LOOK & FEEL
EYEWEAR COLLECTION

- Größen 54-16
Farben 10
12
17
54
16
135
39
15

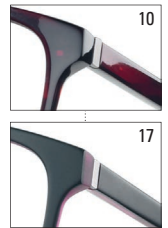

Farbe 12 Zelluloseacetat

XTRA LIGHT ACETATE
premium selection

LOOK & FEEL **5434**



LOOK & FEEL
EYEWEAR COLLECTION

- Größen 53-16
Farben 10
12
15
16
53
16
135
34
16

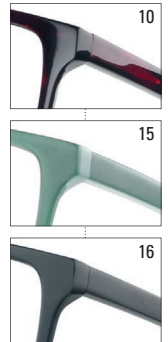

Farbe 12 Zelluloseacetat

XTRA LIGHT ACETATE
premium selection

LOOK & FEEL **5432**



LOOK & FEEL
EYEWEAR COLLECTION

- Größen 54-15
Farben 10
12
16
54
15
135
36
14

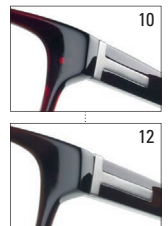

Farbe 16 Zelluloseacetat

XTRA LIGHT ACETATE
premium selection

TOP PREIS LEISTUNG

TOP PREIS LEISTUNG

LOOK & FEEL 5431

LOOK & FEEL
EYEWEAR COLLECTION



XTRA LIGHT ACETATE
premium selection

Farbe 10 Zelluloseacetat

- Größen 54-14
Farben 10
12
16
54
14
140
35
16

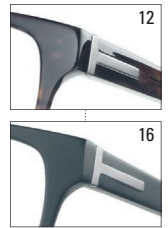

TOP PREIS LEISTUNG

LOOK & FEEL 5414

LOOK & FEEL
EYEWEAR COLLECTION



HAND MADE ACETATE
premium selection

Farbe 16 Zelluloseacetat, Federscharnier

- Größen 53-17
Farben 10
14
16
53
17
135
37
17

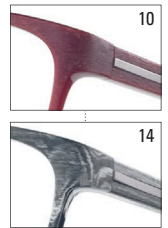

LOOK & FEEL 5413

LOOK & FEEL
EYEWEAR COLLECTION



HAND MADE ACETATE
premium selection

Farbe 10 Zelluloseacetat, Federscharnier

- Größen 52-15
Farben 10
12
16
52
15
140
35
17

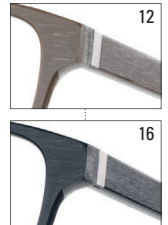

LOOK & FEEL 5406

LOOK & FEEL
EYEWEAR COLLECTION



HAND MADE ACETATE
premium selection

Farbe 16 Zelluloseacetat, Federscharnier

- Größen 50-15
Farben 10
16
50
15
135
32
15



» Look & Feel Herren Metall-, Cell-, Beflex- und Clip-on-Fassungen

LOOK & FEEL 7960

NEU

LOOK & FEEL
EYEWEAR COLLECTION



STAINLESS STEEL
premium selection

Farbe 12 Edelstahl, Federscharnier, Kunststoffbügel

- Größen 56-18
Farben 08
12
14
56
18
140
36
17

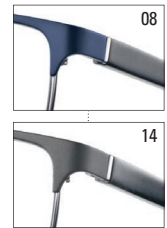

LOOK & FEEL 7959

NEU

LOOK & FEEL
EYEWEAR COLLECTION



STAINLESS STEEL
premium selection

Farbe 12 Edelstahl, Federscharnier, Kunststoffbügel

- Größen 57-18
Farben 08
12
14
57
18
140
34
17

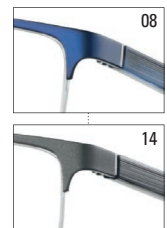

LOOK & FEEL 7958

NEU

LOOK & FEEL
EYEWEAR COLLECTION



STAINLESS STEEL
premium selection

Farbe 14 Edelstahl, Federscharnier, Kunststoffbügel

- Größen 55-17
Farben 08
14
15
55
17
140
37
16

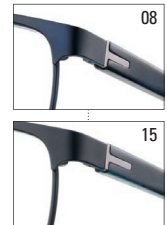

LOOK & FEEL 7957

NEU

LOOK & FEEL
EYEWEAR COLLECTION



STAINLESS STEEL
premium selection

Farbe 16 Edelstahl, Federscharnier

- Größen 52-19
Farben 08
14
16
52
19
140
33
15

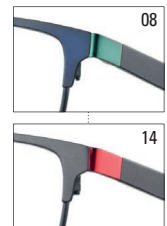

» Look & Feel Herren Metall-, Cell-, Beflex- und Clip-on-Fassungen

LOOK & FEEL **7956**

NEU

LOOK & FEEL
EYEWEAR COLLECTION



STAINLESS STEEL
premium selection

- Größen 57-18
Farben 08
14
16
57
18
140
34
17

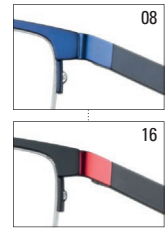

Farbe 14 Edelstahl, Federscharnier

LOOK & FEEL **7955**

NEU

LOOK & FEEL
EYEWEAR COLLECTION



STAINLESS STEEL
premium selection

- Größen 56-17
Farben 08
14
16
56
17
140
35
11

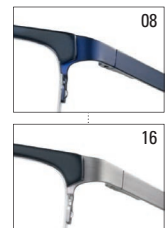

Farbe 14 Edelstahl, Federscharnier, Kombibrille

LOOK & FEEL **7954**

NEU

LOOK & FEEL
EYEWEAR COLLECTION



BEFLEX
STAINLESS STEEL

- Größen 50-17
Farben 08
14
16
50
17
135
30
13

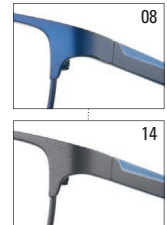

Farbe 16 Edelstahl, Federscharnier, BEFLEX Memorybrücke

LOOK & FEEL **7953**

NEU

LOOK & FEEL
EYEWEAR COLLECTION



BEFLEX
STAINLESS STEEL

- Größen 57-18
Farben 08
14
16
57
18
140
37
16

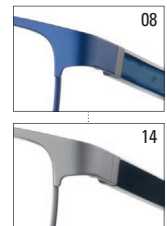

Farbe 16 Edelstahl, Federscharnier, Kunststoffbügel, BEFLEX Memorybrücke

LOOK & FEEL **7952**

NEU

LOOK & FEEL
EYEWEAR COLLECTION



- Größen 52-17
Farben 08
14
16
52
17
140
32
15

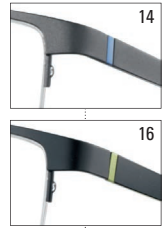

Farbe 08 Edelstahl, Federscharnier, BEFLEX Memorybrücke

LOOK & FEEL **7951**

NEU

LOOK & FEEL
EYEWEAR COLLECTION



- Größen 54-17
Farben 08
14
16
54
17
140
32
15

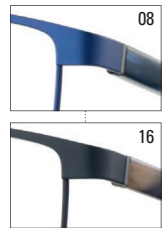

Farbe 14 Edelstahl, Federscharnier, Kunststoffbügel, BEFLEX Memorybrücke

LOOK & FEEL **7950**

NEU

LOOK & FEEL
EYEWEAR COLLECTION



- Größen 55-17
Farben 08
14
16
55
17
140
35
15

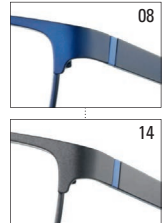

Farbe 16 Edelstahl, Federscharnier, BEFLEX Memorybrücke

LOOK & FEEL **7949**

NEU

LOOK & FEEL
EYEWEAR COLLECTION



- Größen 58-18
Farben 08
14
16
58
18
140
37
15

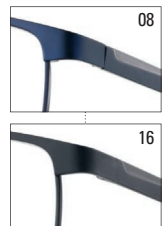

Farbe 14 Edelstahl, Federscharnier, BEFLEX Memorybrücke

» Look & Feel Herren Metall-, Cell-, Beflex- und Clip-on-Fassungen

LOOK & FEEL **7944**

LOOK & FEEL
EYEWEAR COLLECTION



STAINLESS STEEL
premium selection

- Größen 58-18
Farben 08
12
14
58
18
140
36
16

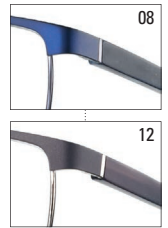

Farbe 14 Edelstahl, Federscharnier, Kunststoffbügel

LOOK & FEEL **7943**

LOOK & FEEL
EYEWEAR COLLECTION



STAINLESS STEEL
premium selection

- Größen 54-18
Farben 08
14
16
54
18
140
35
15

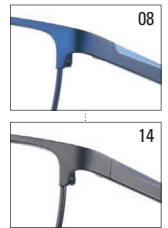

Farbe 16 Edelstahl, Federscharnier

LOOK & FEEL **7942**

LOOK & FEEL
EYEWEAR COLLECTION



STAINLESS STEEL
premium selection

- Größen 55-17
Farben 12
14
16
55
17
140
33
15

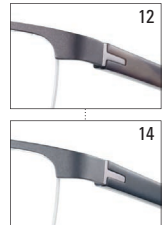

Farbe 16 Edelstahl, Federscharnier, Kunststoffbügel

LOOK & FEEL **7941**

LOOK & FEEL
EYEWEAR COLLECTION



STAINLESS STEEL
premium selection

- Größen 54-17
Farben 08
14
16
54
17
140
32
14

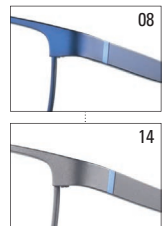

Farbe 16 Edelstahl, Federscharnier

» Look & Feel Herren Metall-, Cell-, Beflex- und Clip-on-Fassungen

LOOK & FEEL **7940**

LOOK & FEEL
EYEWEAR COLLECTION



STAINLESS STEEL
premium selection

- Größen 54-17
Farben 08
14
16
54
17
140
34
16

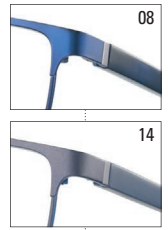

Farbe 16 Edelstahl, Federscharnier, Kunststoffbügel

LOOK & FEEL **7939**

LOOK & FEEL
EYEWEAR COLLECTION



STAINLESS STEEL
premium selection

- Größen 57-17
Farben 08
14
16
57
17
140
36
15

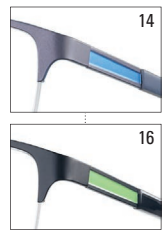

Farbe 08 Edelstahl, Federscharnier

LOOK & FEEL **7938**

LOOK & FEEL
EYEWEAR COLLECTION



STAINLESS STEEL
premium selection

- Größen 57-18
Farben 08
14
16
57
18
140
37
15

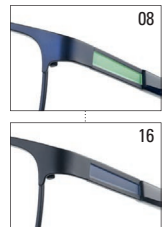

Farbe 14 Edelstahl, Federscharnier

LOOK & FEEL **7926**

LOOK & FEEL
EYEWEAR COLLECTION



STAINLESS STEEL
premium selection

- Größen 53-17
Farben 08
12
16
53
17
140
32
18

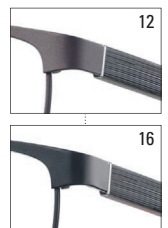

Farbe 08 Edelstahl, Federscharnier, Kunststoffbügel

» Look & Feel Herren Metall-, Cell-, Beflex- und Clip-on-Fassungen

LOOK & FEEL **7923**

LOOK & FEEL
EYEWEAR COLLECTION



STAINLESS STEEL
premium selection

- Größen 55-19
Farben 08
14
16
55
19
140
34
17

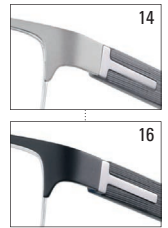

Farbe 08 Edelstahl, Federscharnier, Kunststoffbügel

LOOK & FEEL **7920**

LOOK & FEEL
EYEWEAR COLLECTION



STAINLESS STEEL
premium selection

- Größen 58-17
Farben 08
12
14
58
17
145
36
18

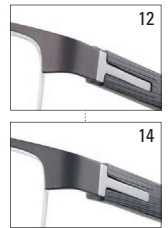

Farbe 08 Edelstahl, Federscharnier, Kunststoffbügel

LOOK & FEEL **7919**

LOOK & FEEL
EYEWEAR COLLECTION



STAINLESS STEEL
premium selection

- Größen 56-16
Farben 08
14
16
56
16
140
34
14

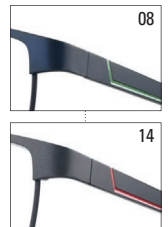

Farbe 16 Edelstahl, Federscharnier

LOOK & FEEL **7918**

LOOK & FEEL
EYEWEAR COLLECTION



STAINLESS STEEL
premium selection

- Größen 55-17
Farben 08
14
16
55
17
140
34
18

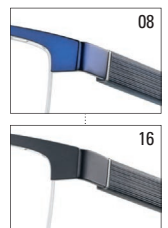

Farbe 14 Edelstahl, Federscharnier, Kunststoffbügel

» Look & Feel Herren Metall-, Cell-, Beflex- und Clip-on-Fassungen

LOOK & FEEL **7917**

LOOK & FEEL
EYEWEAR COLLECTION



STAINLESS STEEL
premium selection

- Größen 57-18
Farben 08
12
16
57
18
145
33
19

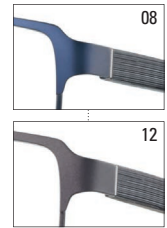

Farbe 16 Edelstahl, Federscharnier, Kunststoffbügel

LOOK & FEEL **7915**

LOOK & FEEL
EYEWEAR COLLECTION



STAINLESS STEEL
premium selection

- Größen 56-18
Farben 08
14
16
56
18
140
36
16

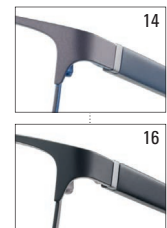

Farbe 08 Edelstahl, Federscharnier, Kunststoffbügel

LOOK & FEEL **7914**

LOOK & FEEL
EYEWEAR COLLECTION



STAINLESS STEEL
premium selection

- Größen 46-20
Farben 12
14
16
46
20
140
38
12

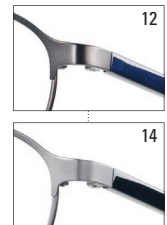

Farbe 16 Edelstahl, Kunststoffbügel

LOOK & FEEL **7913**

LOOK & FEEL
EYEWEAR COLLECTION



BEFLEX
STAINLESS STEEL

- Größen 49-19
Farben 12
14
16
49
19
140
36
9

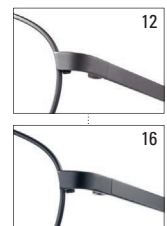

Farbe 14 Edelstahl, BEFLEX Memorybrücke

» Look & Feel Herren Metall-, Cell-, Beflex- und Clip-on-Fassungen

LOOK & FEEL **7910**



LOOK & FEEL
EYEWEAR COLLECTION

- Größen 58-18
Farben 08
12
14
58
18
140
36
19

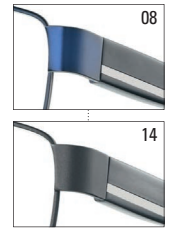

Farbe 12 Edelstahl, Federscharnier, Kunststoffbügel

STAINLESS STEEL
premium selection

LOOK & FEEL **7909**



LOOK & FEEL
EYEWEAR COLLECTION

- Größen 54-18
Farben 08
16
54
18
140
33
16



Farbe 08 Edelstahl, Federscharnier, Kunststoffbügel

STAINLESS STEEL
premium selection

LOOK & FEEL **7908**



LOOK & FEEL
EYEWEAR COLLECTION

- Größen 53-18
Farben 12
14
16
53
18
140
30
16

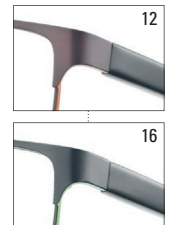

Farbe 14 Edelstahl, Federscharnier, Kunststoffbügel

STAINLESS STEEL
premium selection

LOOK & FEEL **7905**



LOOK & FEEL
EYEWEAR COLLECTION

- Größen 55-19
Farben 08
12
16
55
19
140
36
19

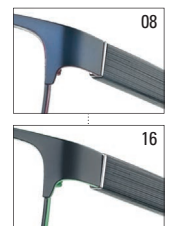

Farbe 12 Edelstahl, Federscharnier, Kunststoffbügel

STAINLESS STEEL
premium selection

» Look & Feel Herren Metall-, Cell-, Beflex- und Clip-on-Fassungen

LOOK & FEEL **7904**

LOOK & FEEL
EYEWEAR COLLECTION



STAINLESS STEEL
premium selection

Farbe 16 Edelstahl, Federscharnier

- Größen 55-19
Farben 08
09
16
55
19
140
35
18

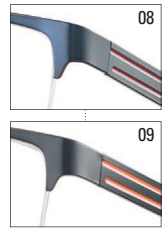

LOOK & FEEL **7888**

LOOK & FEEL
EYEWEAR COLLECTION



STAINLESS STEEL
premium selection

Farbe 14 Edelstahl, Federscharnier, Kunststoffbügel

- Größen 49-19
Farben 12
14
16
49
19
140
37
16

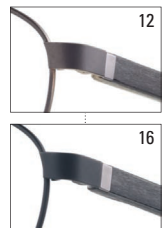

LOOK & FEEL **7883**

LOOK & FEEL
EYEWEAR COLLECTION



STAINLESS STEEL
premium selection

Farbe 12 Edelstahl, Federscharnier

- Größen 57-18
Farben 12
16
57
18
145
38
18



LOOK & FEEL **7882**

LOOK & FEEL
EYEWEAR COLLECTION



STAINLESS STEEL
premium selection

Farbe 08 Edelstahl, Federscharnier, Kunststoffbügel

- Größen 57-18
Farben 08
14
16
57
18
140
35
20

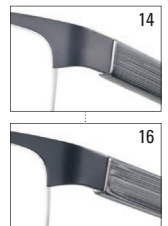

» Look & Feel Herren Metall-, Cell-, Beflex- und Clip-on-Fassungen

LOOK & FEEL **7881**

LOOK & FEEL
EYEWEAR COLLECTION



- Größen 57-18
Farben 12
16
57
18
140
37
20



Farbe 16 Edelstahl, Federscharnier, Kunststoffbügel

STAINLESS STEEL
premium selection

LOOK & FEEL **7878**

LOOK & FEEL
EYEWEAR COLLECTION



- Größen 53-18
Farben 12
14
16
53
18
140
28
18

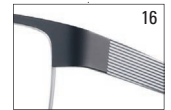

Farbe 12 Edelstahl, Federscharnier, BEFLEX Memorybrücke

BEFLEX
STAINLESS STEEL

LOOK & FEEL **7856**

LOOK & FEEL
EYEWEAR COLLECTION



- Größen 56-18
Farben 08
12
14
56
18
140
34
21



Farbe 12 Edelstahl, Federscharnier, Kunststoffbügel

STAINLESS STEEL
premium selection

LOOK & FEEL **7853**

LOOK & FEEL
EYEWEAR COLLECTION



- Größen 49-18
Farben 12
14
16
49
18
140
38
18



Farbe 14 Edelstahl, Federscharnier, Kunststoffbügel

STAINLESS STEEL
premium selection

» Look & Feel Herren Metall-, Cell-, Beflex- und Clip-on-Fassungen

LOOK & FEEL **7852**

LOOK & FEEL
EYEWEAR COLLECTION



STAINLESS STEEL
premium selection

Farbe 14 Edelstahl

- Größen 55-18
Farben 12
14
16
55
18
140
33
11

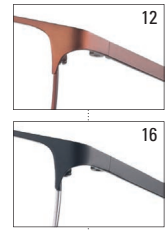

LOOK & FEEL **7808**

LOOK & FEEL
EYEWEAR COLLECTION



STAINLESS STEEL
premium selection

Farbe 12 Edelstahl, Federscharnier, Kunststoffbügel

- Größen 59-18
Farben 12
14
16
59
18
145
37
21

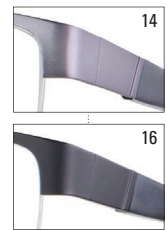

LOOK & FEEL **7800**

LOOK & FEEL
EYEWEAR COLLECTION



STAINLESS STEEL
premium selection

Farbe 12 Edelstahl, Federscharnier, Kunststoffbügel

- Größen 58-18
Farben 08
12
14
58
18
140
36
22

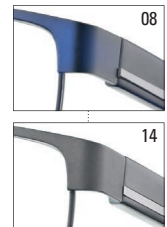

LOOK & FEEL **7792**

LOOK & FEEL
EYEWEAR COLLECTION



STAINLESS STEEL
premium selection

Farbe 12 Edelstahl, Federscharnier, Kunststoffbügel

- Größen 55-17
Farben 12
14
55
17
140
35
24



» Look & Feel Herren Metall-, Cell-, Beflex- und Clip-on-Fassungen

LOOK & FEEL 6216



LOOK & FEEL
EYEWEAR COLLECTION

XTRA LIGHT ACETATE
premium selection
MAGNETIC CLIP-ON
polarized lenses

Größen 49-20

Farben 10

12

16

49

20

140

40

13

Gewicht ohne Clip

inkl. schwarzem
Magnet-Sonnenclip



10



12

Farbe 16 Zelluloseacetat, Federscharnier



LOOK & FEEL 6215



LOOK & FEEL
EYEWEAR COLLECTION

XTRA LIGHT ACETATE
premium selection

Größen 53-16

Farben 08

11

14

16

53

16

145

40

11



08

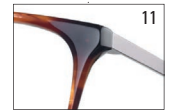

11



16

Farbe 14 Zelluloseacetat, Metallbügel

LOOK & FEEL 6214



LOOK & FEEL
EYEWEAR COLLECTION

XTRA LIGHT ACETATE
premium selection

Größen 51-17

Farben 08

12

16

51

17

145

34

10



08



12

Farbe 16 Zelluloseacetat, Metallbügel

LOOK & FEEL 6213



LOOK & FEEL
EYEWEAR COLLECTION

XTRA LIGHT ACETATE
premium selection

Größen 56-15

Farben 08

12

16

56

15

145

36

11



12



16

Farbe 08 Zelluloseacetat, Metallbügel

LOOK & FEEL 6211



LOOK & FEEL
EYEWEAR COLLECTION

XTRA LIGHT ACETATE
premium selection
MAGNETIC CLIP-ON
polarized lenses

- Größen 55-15
Farben 08
12
16
55
15
140
37
13

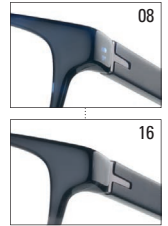

Farbe 12 Zelluloseacetat, Federscharnier



Gewicht ohne Clip
inkl. schwarzem
Magnet-Sonnenclip

LOOK & FEEL 6210



LOOK & FEEL
EYEWEAR COLLECTION

XTRA LIGHT ACETATE
premium selection
MAGNETIC CLIP-ON
polarized lenses

- Größen 57-15
Farben 08
12
16
57
15
140
37
14

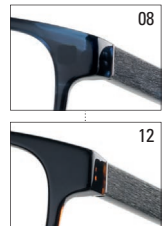

Farbe 16 Zelluloseacetat, Federscharnier



Gewicht ohne Clip
inkl. schwarzem
Magnet-Sonnenclip

LOOK & FEEL 6209



LOOK & FEEL
EYEWEAR COLLECTION

XTRA LIGHT ACETATE
premium selection
MAGNETIC CLIP-ON
polarized lenses

- Größen 55-16
Farben 08
12
16
55
16
140
37
13

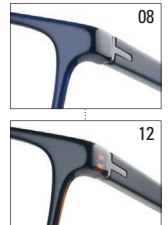

Farbe 16 Zelluloseacetat, Federscharnier



Gewicht ohne Clip
inkl. schwarzem
Magnet-Sonnenclip

LOOK & FEEL 6194



LOOK & FEEL
EYEWEAR COLLECTION

XTRA LIGHT ACETATE
premium selection

- Größen 54-16
Farben 08
10
16
54
16
140
36
10

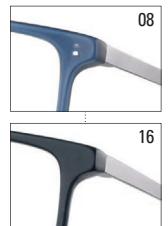

Farbe 10 Zelluloseacetat, Metallbügel

LOOK & FEEL 6193



LOOK & FEEL
EYEWEAR COLLECTION

- Größen 49-17
Farben 08
16
49
17
140
40
14



Farbe 16 Zelluloseacetat, Federscharnier

XTRA LIGHT ACETATE
premium selection

LOOK & FEEL 6192



LOOK & FEEL
EYEWEAR COLLECTION

- Größen 56-16
Farben 08
12
16
56
16
145
40
16



Farbe 16 Zelluloseacetat, Federscharnier

XTRA LIGHT ACETATE
premium selection

LOOK & FEEL 6191



LOOK & FEEL
EYEWEAR COLLECTION

- Größen 55-16
Farben 08
12
16
55
16
145
33
14



Farbe 08 Zelluloseacetat, Federscharnier

XTRA LIGHT ACETATE
premium selection

LOOK & FEEL 6190



LOOK & FEEL
EYEWEAR COLLECTION

- Größen 54-15
Farben 08
10
16
54
15
140
34
14



Farbe 10 Zelluloseacetat, Federscharnier

XTRA LIGHT ACETATE
premium selection

» Look & Feel Herren Metall-, Cell-, Beflex- und Clip-on-Fassungen

LOOK & FEEL **6188**

LOOK & FEEL
EYEWEAR COLLECTION



Größen 54-16

Farben 08

12

14

16

54

16

140

32

16



12



14



16

Farbe 08 Zelluloseacetat, Federscharnier

XTRA LIGHT ACETATE
premium selection

LOOK & FEEL **6187**

LOOK & FEEL
EYEWEAR COLLECTION



Größen 54-16

Farben 08

12

14

16

54

16

140

36

14



08

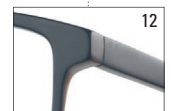

12



14

Farbe 16 Zelluloseacetat, Federscharnier

XTRA LIGHT ACETATE
premium selection

LOOK & FEEL **6186**

LOOK & FEEL
EYEWEAR COLLECTION



Größen 57-15

Farben 08

12

16

57

15

140

38

18



12



16

Farbe 08 Zelluloseacetat, Federscharnier

XTRA LIGHT ACETATE
premium selection

LOOK & FEEL **6185**

LOOK & FEEL
EYEWEAR COLLECTION



Größen 53-17

Farben 08

14

16

53

17

140

31

14



14



16

Farbe 08 Zelluloseacetat

XTRA LIGHT ACETATE
premium selection

LOOK & FEEL **6184**

LOOK & FEEL
EYEWEAR COLLECTION



- Größen 56-17
Farben 08
12
14
56
17
140
36
15

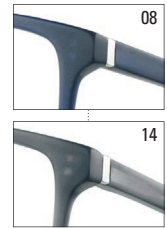

Farbe 12 Zelluloseacetat

XTRA LIGHT ACETATE
premium selection

LOOK & FEEL **6183**

LOOK & FEEL
EYEWEAR COLLECTION



- Größen 54-16
Farben 08
14
16
54
16
140
33
14

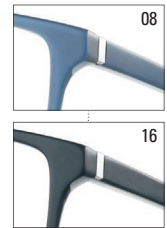

Farbe 14 Zelluloseacetat

XTRA LIGHT ACETATE
premium selection

LOOK & FEEL **6182**

LOOK & FEEL
EYEWEAR COLLECTION



- Größen 54-15
Farben 08
10
16
54
15
140
34
16

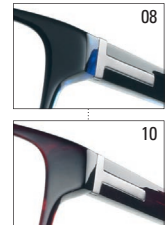

Farbe 16 Zelluloseacetat

XTRA LIGHT ACETATE
premium selection

TOP PREIS LEISTUNG

LOOK & FEEL **6181**

LOOK & FEEL
EYEWEAR COLLECTION



- Größen 54-16
Farben 08
12
16
54
16
140
35
15

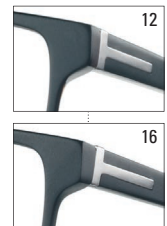

Farbe 08 Zelluloseacetat

XTRA LIGHT ACETATE
premium selection

LOOK & FEEL **6169**

LOOK & FEEL
EYEWEAR COLLECTION



- Größen 52-15
Farben 08
12
16
52
15
140
32
16

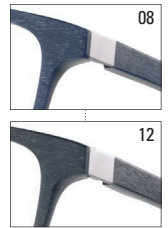

HAND MADE ACETATE
premium selection

Farbe 16 Zelluloseacetat, Federscharnier

LOOK & FEEL **6168**

LOOK & FEEL
EYEWEAR COLLECTION



- Größen 57-17
Farben 12
16
57
17
140
38
19



HAND MADE ACETATE
premium selection

Farbe 12 Zelluloseacetat, Federscharnier

LOOK & FEEL **6167**

LOOK & FEEL
EYEWEAR COLLECTION



- Größen 56-17
Farben 12
14
56
17
140
37
17



HAND MADE ACETATE
premium selection

Farbe 12 Zelluloseacetat, Federscharnier

TOP PREIS LEISTUNG

LOOK & FEEL **6166**

LOOK & FEEL
EYEWEAR COLLECTION



- Größen 53-16
Farben 08
12
16
53
16
140
36
12

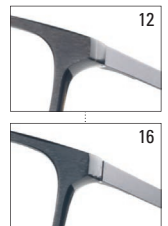

HAND MADE ACETATE
premium selection

Farbe 08 Zelluloseacetat, Federscharnier, Metallbügel

LOOK & FEEL 6164



LOOK & FEEL
EYEWEAR COLLECTION

- Größen 49-19
 Farben 11
 16
 49
 19
 140
 39
 19



16

HAND MADE ACETATE
premium selection

Farbe 11 Zelluloseacetat, Federscharnier

LOOK & FEEL 6163



LOOK & FEEL
EYEWEAR COLLECTION

- Größen 58-16
 Farben 12
 14
 16
 58
 16
 145
 38
 18



14



16

HAND MADE ACETATE
premium selection

Farbe 12 Zelluloseacetat, Federscharnier, Metallbügel

women **8230**

NEU

women
eyewear



STAINLESS STEEL
premium selection

Farbe 04 Edelstahl, Federscharnier

- Größen 53-16
Farben 04
10
12
53
16
135
35
16

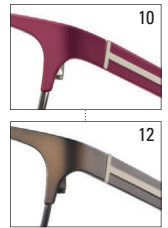

women **8222**

NEU

women
eyewear



STAINLESS STEEL
premium selection

Farbe 10 Edelstahl, Federscharnier

- Größen 55-16
Farben 10
12
14
55
16
135
35
14



women **8221**

NEU

women
eyewear



STAINLESS STEEL
premium selection

Farbe 10 Edelstahl, Federscharnier

- Größen 52-17
Farben 10
12
14
52
17
135
35
14

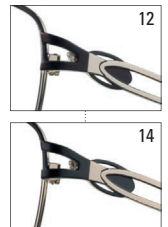

women **8220**

NEU

women
eyewear



STAINLESS STEEL
premium selection

Farbe 10 Edelstahl, Federscharnier, Kunststoffbügel

- Größen 52-16
54-16
Farben 10
12
52/54
16
135
36/38
15



women **8190**

women
eyewear



STAINLESS STEEL
premium selection

Farbe 10 Edelstahl, Federscharnier

- Größen 50-17
52-17
Farben 10
12
14
50/52
17
130/135
33/35
12

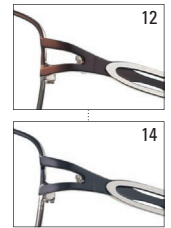

women **8189**

women
eyewear



STAINLESS STEEL
premium selection

Farbe 14 Edelstahl, Federscharnier

- Größen 53-16
Farben 10
12
14
53
16
135
34
13

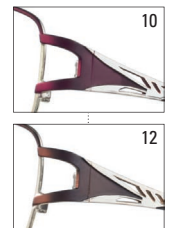

women **8188**

women
eyewear



STAINLESS STEEL
premium selection

Farbe 12 Edelstahl, Federscharnier, Kunststoffbügel

- Größen 54-16
Farben 10
12
15
54
16
135
36
15

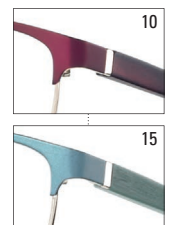

women **8187**

women
eyewear



STAINLESS STEEL
premium selection

Farbe 12 Edelstahl, Federscharnier, Kunststoffbügel

- Größen 53-16
Farben 10
12
14
53
16
135
37
14

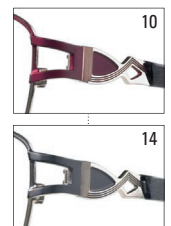

women **8186**

women
eyewear



STAINLESS STEEL
premium selection

Farbe 10 Edelstahl, Federscharnier, Kunststoffbügel

- Größen 49-17
51-17
Farben 10
12
15
15
49/51
17
130/135
33/35
14

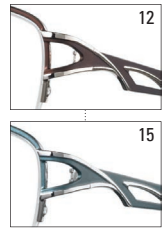

women **8152**

women
eyewear



STAINLESS STEEL
premium selection

Farbe 10 Edelstahl, Federscharnier

- Größen 50-17
52-17
Farben 10
12
14
14
50/52
17
130/135
34/35
14

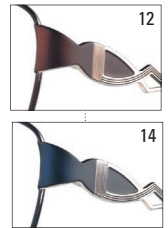

women **8151**

women
eyewear



STAINLESS STEEL
premium selection

Farbe 14 Edelstahl, Federscharnier, Kunststoffbügel

- Größen 53-18
Farben 10
12
14
14
53
18
135
34
18

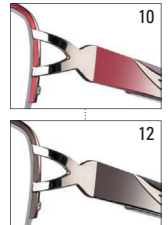

women **8150**

women
eyewear



STAINLESS STEEL
premium selection

Farbe 12 Edelstahl, Federscharnier

- Größen 53-16
Farben 12
15
17
17
53
16
135
36
14

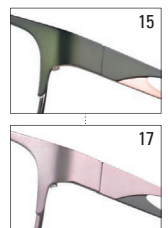

women **8148**

women
eyewear



STAINLESS STEEL
premium selection

Farbe 02 Edelstahl, Federscharnier

Größen 53-16

Farben 02

12

17

⊖

⊕

⌒

⌒

⌒

⌒

⌒

⌒

⌒

⌒

⌒

⌒

⌒

⌒

⌒

⌒

⌒

⌒

⌒

⌒

⌒

⌒

⌒

⌒

⌒

⌒

⌒

⌒

⌒

⌒

⌒

⌒

⌒

⌒

⌒

⌒

⌒

⌒

⌒

⌒

⌒

⌒

⌒

⌒

⌒

⌒

⌒

⌒

⌒

⌒

⌒

⌒

⌒

⌒

⌒

⌒

⌒

⌒

⌒

⌒

⌒

⌒

⌒

⌒



12



17

women **8102**

women
eyewear



STAINLESS STEEL
premium selection

Farbe 12 Edelstahl

Größen 55-15

Farben 10

12

15

⊖

⊕

⌒

⌒

⌒

⌒

⌒

⌒

⌒

⌒

⌒

⌒

⌒

⌒

⌒

⌒

⌒

⌒

⌒

⌒

⌒

⌒

⌒

⌒

⌒

⌒

⌒

⌒

⌒

⌒

⌒

⌒

⌒

⌒

⌒

⌒

⌒

⌒

⌒

⌒

⌒

⌒

⌒

⌒

⌒

⌒

⌒



10

men **7925**

men
eyewear



STAINLESS STEEL
premium selection

- Größen 54-18
56-18
Farben 02
14
54/56
18
140
37/38
18



02

Farbe 14 Edelstahl, Federscharnier, Kunststoffbügel

men **7924**

men
eyewear



STAINLESS STEEL
premium selection

- Größen 56-17
58-17
Farben 02
14
56/58
17
140/145
37/39
15



14

Farbe 02 Edelstahl, Federscharnier, Kunststoffbügel

men **7884**

men
eyewear



BEFLEX
STAINLESS STEEL

- Größen 55-19
Farben 02
16
55
19
140
38
17



02

Farbe 16 Edelstahl, Federscharnier, Kunststoffbügel, BEFLEX Memorybrücke

men **7862**

men
eyewear



STAINLESS STEEL
premium selection

- Größen 54-19
56-19
Farben 02
14
54/56
19
140
36/38
17



14

Farbe 02 Edelstahl, Federscharnier, Kunststoffbügel

men **7860**

men
eyewear



STAINLESS STEEL
premium selection

- Größen 54-19
56-19
Farben 02
14
54/56
19
140
34/36
15



02

Farbe 14 Edelstahl, Federscharnier, Kunststoffbügel

men **7798**

men
eyewear



STAINLESS STEEL
premium selection

- Größen 58-17
60-17
Farben 12
14
58/60
17
140/145
38/40
19



12

Farbe 14 Edelstahl, Federscharnier

men **7788**

men
eyewear



STAINLESS STEEL
premium selection

- Größen 50-17
52-17
Farben 02
14
50/52
17
135/140
33/34
10



02

Farbe 14 Edelstahl, Federscharnier

men **7759**

men
eyewear



STAINLESS STEEL
premium selection

- Größen 57-18
59-18
Farben 01
02
57/59
18
140
34/36
17



01

Farbe 02 Edelstahl, Federscharnier, Kunststoffbügel

men **7753**

men
eyewear



STAINLESS STEEL
premium selection

- Größen 54-18
56-18
Farben 02
14
54/56
18
140
34/36
14



14

Farbe 02 Edelstahl, Federscharnier, Kunststoffbügel

men **7752**

men
eyewear



STAINLESS STEEL
premium selection

- Größen 53-19
55-19
Farben 02
14
53/55
19
140
34/36
13



14

Farbe 02 Edelstahl, Federscharnier, Kunststoffbügel

men **7746**

men
eyewear



- Größen 55-19
57-19
Farben 02
14
55/57
19
140/145
35/37
18



14

Farbe 02 Federscharnier

Jump Up **2904**

NEU

JUMP UP
DIE BRILLE



- Größen 50-19
Farben 08
14
16
50
19
135
30
16

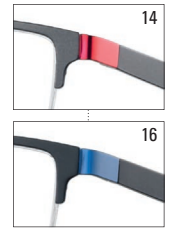

STAINLESS STEEL
premium selection

Farbe 08 Edelstahl, Federscharnier

Jump Up Teens **2903**

JUMP UP
TEENS



- Größen 49-17
Farben 08
12
16
49
17
135
30
12

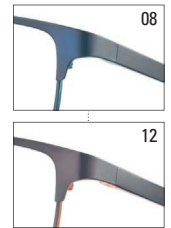

STAINLESS STEEL
premium selection

Farbe 16 Edelstahl, Federscharnier

Jump Up Teens **2899**

JUMP UP
TEENS



- Größen 51-16
Farben 08
14
16
51
16
135
32
16

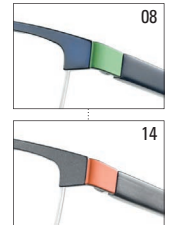

STAINLESS STEEL
premium selection

Farbe 16 Edelstahl, Federscharnier, Kunststoffbügel

Jump Up Teens **2897**

JUMP UP
TEENS



- Größen 51-17
Farben 08
14
16
51
17
135
30
14

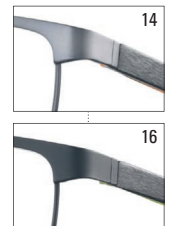

STAINLESS STEEL
premium selection

Farbe 08 Edelstahl, Federscharnier, Kunststoffbügel

Jump Up Teens **2889**



JUMP UP
TEENS

Größen 49-18

Farben 08

14

16

49

18

135

30

16

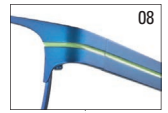

08

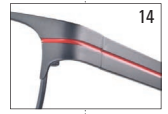

14

STAINLESS STEEL
premium selection

Farbe 16 Edelstahl, Federscharnier

Jump Up **2887**



JUMP UP
DIE BRILLE

Größen 50-16

Farben 10

12

17

50

16

130

34

15

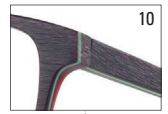

10



17

HAND MADE ACETATE
premium selection

Farbe 12 Zelluloseacetat, Federscharnier

Jump Up Teens **2880**



JUMP UP
TEENS

Größen 48-16

Farben 08

14

48

16

135

29

16



08

STAINLESS STEEL
premium selection

Farbe 14 Edelstahl, Federscharnier, Kunststoffbügel

› **WICHTIGE SERVICE-INFORMATIONEN**
zum OBE-Federscharnier (flexUno)



Modellreihe flexUno 2.7: BI 4271, BI 4272, BI 4273, BI 4277, BI 4278, BI 4279, BI 4280, BI 4281, BI 4282

Modellreihe flexUno 3.0: BI 4266, BI 4267, BI 4268, BI 4269, BI 4270

Entriegeln

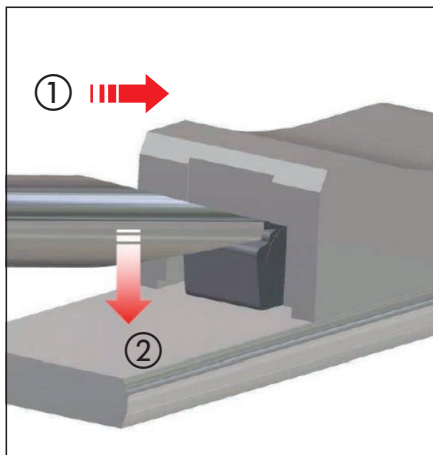

Montage

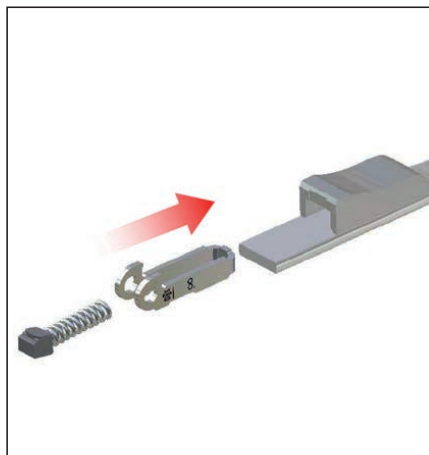

Verriegeln

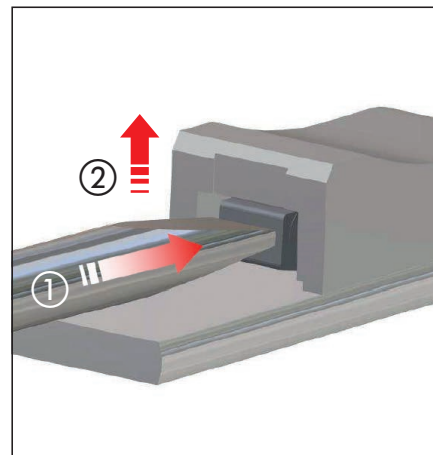

› Ersatzteile auf Seite 89

Kids One **4282**



HAND MADE ACETATE
premium selection



- Größen 45-16
47-16
Farben 05
10
17
⊖ 45/47
⊕ 16
⌒ 125/130
⌚ 29/31
⌚ 14

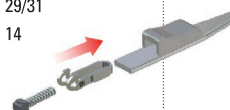

Farbe 05 Zelluloseacetat, Federscharnier, OBE-Präzisionsscharnier

Kids One **4281**



HAND MADE ACETATE
premium selection



- Größen 43-16
45-16
Farben 08
10
16
17
⊖ 43/45
⊕ 16
⌒ 120/125
⌚ 34/36
⌚ 13

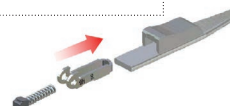

Farbe 17 Zelluloseacetat, Metallbügel, Federscharnier, OBE-Präzisionsscharnier

Kids One **4280**



HAND MADE ACETATE
premium selection

Größen 45-14
47-14

Farben 10
16
17

⊖ 45/47
⊕ 14
⌒ 125/130
⌚ 28/29
Ⓜ 15

Farbe 10 Zelluloseacetat, Federscharnier, OBE-Präzisionsscharnier

Kids One **4279**



STAINLESS STEEL
premium selection

Größen 45-16
47-16

Farben 07
10
17

⊖ 45/47
⊕ 16
⌒ 125/130
⌚ 29/30
Ⓜ 15

Farbe 17 Edelstahl, Federscharnier, OBE-Präzisionsscharnier, Kunststoffbügel

Kids One **4278**



STAINLESS STEEL
premium selection

Größen 46-18
48-18

Farben 08
09
16

⊖ 46/48
⊕ 18
⌒ 125/130
⌚ 28/29
Ⓜ 15

Farbe 08 Edelstahl, Federscharnier, OBE-Präzisionsscharnier, Kunststoffbügel

Kids One **4277**



STAINLESS STEEL
premium selection

Größen 42-16
44-16

Farben 08
10
16

⊖ 42/44
⊕ 16
⌒ 120/125
⌚ 33/35
Ⓜ 16

Farbe 10 Edelstahl, Federscharnier, OBE-Präzisionsscharnier, Kunststoffbügel

Kids One **4271**



- Größen 45-16
47-16
Farben 07
08
16
45/47
16
125/130
28/29
15

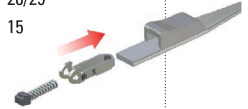
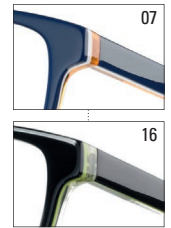

Farbe 08 Zelluloseacetat, Federscharnier, OBE-Präzisionsscharnier

Kids One **4270**



- Größen 44-17
46-17
Farben 08
14
15
44/46
17
120/125
28/29
14

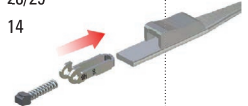
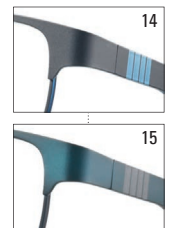

Farbe 08 Edelstahl, Federscharnier, OBE-Präzisionsscharnier

Kids One **4268**



- Größen 45-17
47-17
Farben 08
16
45/47
17
120/125
27/28
15

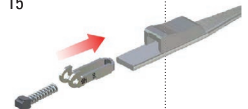

Farbe 16 Edelstahl, Federscharnier, OBE-Präzisionsscharnier

Kids One **4267**



- Größen 45-15
Farben 10
17
45
15
125
27
14

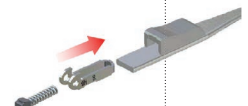

Farbe 10 Edelstahl, Federscharnier, OBE-Präzisionsscharnier

Kids One **4266**

KID'S ONE®



Größen 44-16

46-16

Farben 10

17

44/46

16

120/125

28/30

14

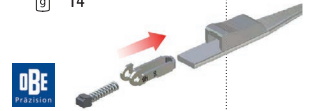

Farbe 17 Edelstahl, Federscharnier, OBE-Präzisionsscharnier

TOP PREIS LEISTUNG

Kids One **4257**

KID'S ONE®



Größen 44-16

46-16

Farben 08

10

15

44/46

16

125/130

25/26

14

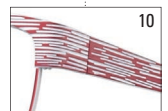
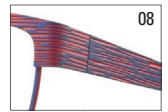

Farbe 15 Edelstahl, Federscharnier

Skylight **3113**

NEU

SKYLIGHT
TITANIUM EYEWEAR



BETA-TITANIUM

Nickel Allergy Free

Farbe 08 Beta Titan, Federscharnier, Kunststoffbügel

Größen 57-18

Farben 08

14

16

57

18

140

36

14



14



16

Skylight **3112**

NEU

SKYLIGHT
TITANIUM EYEWEAR



BETA-TITANIUM

Nickel Allergy Free

Farbe 12 Beta Titan, Federscharnier

Größen 49-17

Farben 12

15

17

49

17

130

33

10



15



17

Skylight **3111**

NEU

SKYLIGHT
TITANIUM EYEWEAR



BETA-TITANIUM

Nickel Allergy Free

Farbe 08 Beta Titan, Federscharnier

Größen 53-16

Farben 08

12

16

53

16

135

35

11



12



16

Skylight **3110**

NEU

SKYLIGHT
TITANIUM EYEWEAR



BETA-TITANIUM

Nickel Allergy Free

Farbe 16 Beta Titan, Federscharnier

Größen 48-18

Farben 12

15

16

48

18

135

39

9



12



15

Skylight **3109**

NEU

SKYLIGHT
TITANIUM EYEWEAR



BETA-TITANIUM
Nickel Allergy Free

- Größen 50-17
Farben 10
12
14
50
17
135
35
9

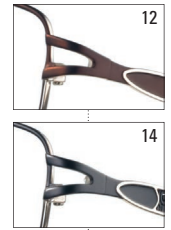

Farbe 10 Beta Titan, Federscharnier

Skylight **3108**

NEU

SKYLIGHT
TITANIUM EYEWEAR



BETA-TITANIUM
Nickel Allergy Free

- Größen 54-16
Farben 10
12
15
54
16
135
38
11

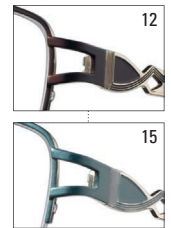

Farbe 10 Beta Titan, Federscharnier

Skylight **3107**

NEU

SKYLIGHT
TITANIUM EYEWEAR



BETA-TITANIUM
Nickel Allergy Free

- Größen 52-17
Farben 10
12
14
52
17
135
36
09

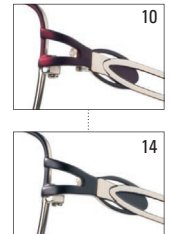

Farbe 12 Beta Titan, Federscharnier

Skylight **3106**

SKYLIGHT
TITANIUM EYEWEAR



BETA-TITANIUM
Nickel Allergy Free

- Größen 55-16
Farben 08
12
16
55
16
140
38
12

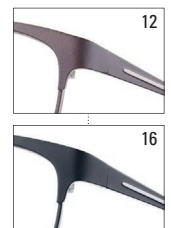

Farbe 08 Beta Titan, Federscharnier

Skylight **3105**



SKYLIGHT
TITANIUM EYEWEAR

BETA-TITANIUM
Nickel Allergy Free

- Größen 54-16
Farben 12
16
17
54
16
135
35
10

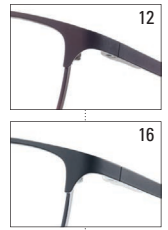

Farbe 17 Beta Titan, Federscharnier

Skylight **3104**



SKYLIGHT
TITANIUM EYEWEAR

BETA-TITANIUM
Nickel Allergy Free

- Größen 49-17
Farben 10
12
16
49
17
135
35
10

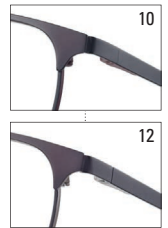

Farbe 16 Beta Titan, Federscharnier

Skylight **3103**



SKYLIGHT
TITANIUM EYEWEAR

BETA-TITANIUM
Nickel Allergy Free

- Größen 53-16
Farben 10
12
53
16
135
37
11



Farbe 12 Beta Titan, Federscharnier

Skylight **3102**



SKYLIGHT
TITANIUM EYEWEAR

BETA-TITANIUM
Nickel Allergy Free

- Größen 55-18
Farben 08
14
16
55
18
140
35
11

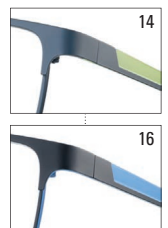





Farbe 08 Beta Titan, Federscharnier

Skylight **3101**



SKYLIGHT
TITANIUM EYEWEAR

BETA-TITANIUM
Nickel Allergy Free

- Größen 57-17
 Farben 08
 12
 16

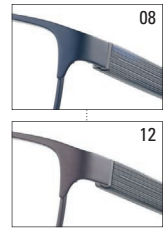

 13







Farbe 16 Beta Titan, Federscharnier, Kunststoffbügel

Skylight **3100**



SKYLIGHT
TITANIUM EYEWEAR

BETA-TITANIUM
Nickel Allergy Free

- Größen 56-18
 Farben 08
 14
 16

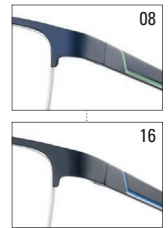

 11







Farbe 14 Beta Titan, Federscharnier

Skylight **535**



SKYLIGHT
TITANIUM EYEWEAR

BETA-TITANIUM
Nickel Allergy Free

- Größen 52-16
 Farben 08
 10



 12







Farbe 08 Beta Titan, Federscharnier

Skylight **529**



SKYLIGHT
TITANIUM EYEWEAR

BETA-TITANIUM
Nickel Allergy Free

- Größen 55-18
 Farben 02
 14
 55



 13



Farbe 02 Beta Titan, Federscharnier

Skylight **512**



SKYLIGHT
TITANIUM EYEWEAR

BETA-TITANIUM
Nickel Allergy Free

- Größen 51-18
53-18
Farben 12
14
⊖ 51/53
⊕ 18
⌒ 140
Ⓢ 33/34
Ⓜ 9



12

Farbe 14 Beta Titan, Federscharnier

Skylight **511**



SKYLIGHT
TITANIUM EYEWEAR

BETA-TITANIUM
Nickel Allergy Free

- Größen 50-18
Farben 02
12
⊖ 50
⊕ 18
⌒ 140
Ⓢ 34
Ⓜ 9



12

Farbe 02 Beta Titan, Federscharnier

readers **1181**



XTRA LIGHT ACETATE
premium selection

Farbe 16 Zelluloseacetat, Federscharnier

- Größen 52-20
Farben 08
12
16
52
20
145
23
12

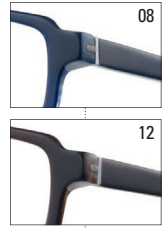

readers **1180**



STAINLESS STEEL
premium selection

Farbe 10 Edelstahl, Federscharnier, Kunststoffbügel

- Größen 49-20
Farben 10
12
15
16
49
20
145
23
15

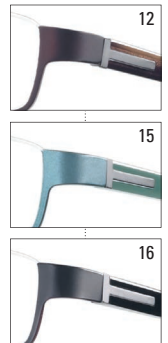

readers **1179**



HAND MADE ACETATE
premium selection

Farbe 08 Zelluloseacetat, Federscharnier

- Größen 51-21
Farben 08
10
16
51
21
145
24
16

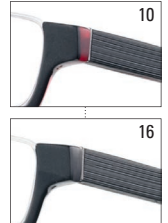

readers **1178**



STAINLESS STEEL
premium selection

Farbe 12 Edelstahl, Federscharnier, Kunststoffbügel

- Größen 49-20
Farben 10
12
16
49
20
145
23
13

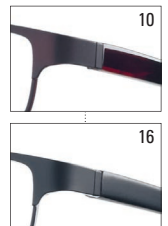

readers **1177**



STAINLESS STEEL
premium selection

- Größen 50-20
Farben 10
12
16
50
20
145
23
14

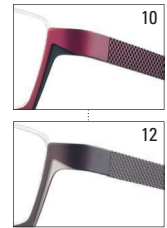

Farbe 16 Edelstahl, Federscharnier

readers **1176**



STAINLESS STEEL
premium selection

- Größen 49-20
Farben 10
12
16
49
20
145
23
14

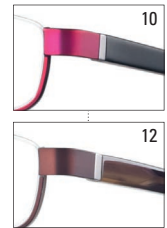

Farbe 16 Edelstahl, Federscharnier, Kunststoffbügel

readers **1175**



STAINLESS STEEL
premium selection

- Größen 50-19
Farben 10
12
16
50
19
145
24
15

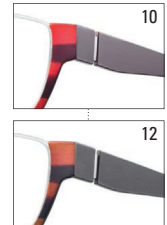

Farbe 16 Edelstahl, Federscharnier

readers **1174**



STAINLESS STEEL
premium selection

- Größen 49-19
Farben 08
12
16
49
19
145
24
11

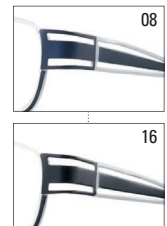

Farbe 12 Edelstahl, Federscharnier

readers **1173**



STAINLESS STEEL
premium selection

Farbe 10 Edelstahl, Federscharnier, Kunststoffbügel

- Größen 48-21
Farben 10
12
15
48
21
145
23
14

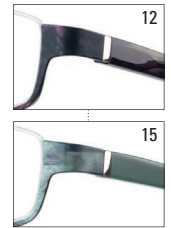

readers **1170**



STAINLESS STEEL
premium selection

Farbe 16 Edelstahl, Federscharnier, Kunststoffbügel

- Größen 51-22
Farben 12
14
16
51
22
145
23
17

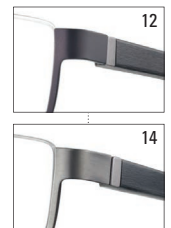

readers **1169**



STAINLESS STEEL
premium selection

Farbe 08 Edelstahl, Federscharnier, Kunststoffbügel

- Größen 51-22
Farben 08
14
16
51
22
145
26
18

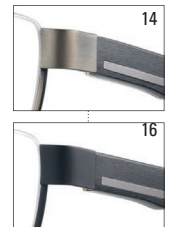

readers **1168**



BEFLEX
STAINLESS STEEL

Farbe 16 Edelstahl, Federscharnier, Kunststoffbügel, BEFLEX Memorybrücke

- Größen 52-22
Farben 12
14
16
52
22
145
26
14

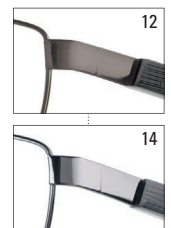

readers **1165**



- Größen 53-21
 Farben 12
 16
 53
 21
 145
 24
 18



Farbe 16 Edelstahl, Federscharnier, Kunststoffbügel, BEFLEX Memorybrücke

readers **1163**



- Größen 51-22
 Farben 12
 14
 16
 51
 22
 145
 24
 15



STAINLESS STEEL
premium selection

Farbe 14 Edelstahl, Federscharnier

readers **1155**



- Größen 52-22
 Farben 08
 12
 16
 52
 22
 145
 26
 19



STAINLESS STEEL
premium selection

Farbe 16 Edelstahl, Federscharnier, Kunststoffbügel

readers **1143**



- Größen 51-20
 Farben 12
 14
 16
 51
 20
 145
 22
 20



STAINLESS STEEL
premium selection

Farbe 14 Edelstahl, Federscharnier, Kunststoffbügel, Vollsteg

TOP PREIS LEISTUNG

Start Up Premium **8219**

NEU

STARTUP
premium



STAINLESS STEEL
premium selection

Farbe 12 Edelstahl, Federscharnier

- Größen 55-16
Farben 10
12
16
55
16
135
38
18

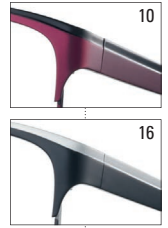

TOP PREIS LEISTUNG

Start Up Premium **8217**

NEU

STARTUP
premium



STAINLESS STEEL
premium selection

Farbe 16 Edelstahl, Federscharnier

- Größen 52-17
Farben 10
12
16
52
17
135
36
15

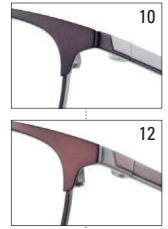

TOP PREIS LEISTUNG

Start Up Premium **8216**

NEU

STARTUP
premium



STAINLESS STEEL
premium selection

Farbe 08 Edelstahl, Federscharnier, Kunststoffbügel

- Größen 49-16
Farben 08
12
16
49
16
130
33
15

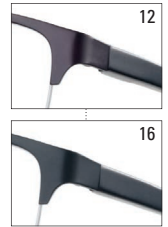

TOP PREIS LEISTUNG

Start Up Premium **8215**

NEU

STARTUP
premium



STAINLESS STEEL
premium selection

Farbe 10 Edelstahl, Federscharnier, Kunststoffbügel

- Größen 52-17
Farben 10
12
16
52
17
135
35
16

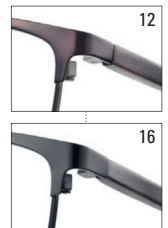

TOP PREIS LEISTUNG

Start Up Premium **8201**

STARTUP
premium



STAINLESS STEEL
premium selection

Farbe 08 Edelstahl, Federscharnier

- Größen 52-17
Farben 08
12
16
52
17
135
37
14

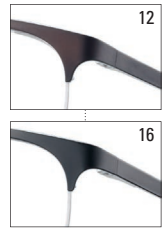

TOP PREIS LEISTUNG

Start Up Premium **8200**

STARTUP
premium



STAINLESS STEEL
premium selection

Farbe 12 Edelstahl, Federscharnier

- Größen 53-16
Farben 10
12
16
53
16
135
37
14



TOP PREIS LEISTUNG

Start Up Premium **8199**

STARTUP
premium



STAINLESS STEEL
premium selection

Farbe 10 Edelstahl, Federscharnier, Kunststoffbügel

- Größen 54-16
Farben 10
12
16
54
16
135
37
18

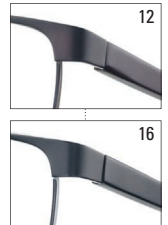

TOP PREIS LEISTUNG

Start Up Premium **8183**

STARTUP
premium



STAINLESS STEEL
premium selection

Farbe 16 Edelstahl, Federscharnier

- Größen 53-16
Farben 08
10
16
53
16
135
35
14

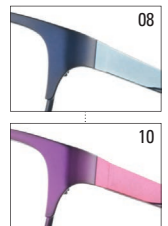

TOP PREIS LEISTUNG

Start Up Premium **8166**

STARTUP
premium



- Größen 53-17
Farben 12
14
17
53
17
135
35
20

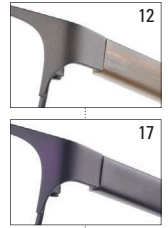

Farbe 14 Edelstahl, Federscharnier, Kunststoffbügel

STAINLESS STEEL
premium selection

TOP PREIS LEISTUNG

Start Up Premium **8165**

STARTUP
premium



- Größen 52-16
Farben 12
16
17
52
16
135
33
16

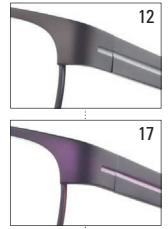

Farbe 16 Edelstahl, Federscharnier

STAINLESS STEEL
premium selection

TOP PREIS LEISTUNG

Start Up Premium **7948**

NEU

STARTUP
premium



- Größen 54-18
Farben 08
14
16
54
18
140
33
15

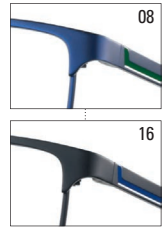

Farbe 14 Edelstahl, Federscharnier

STAINLESS STEEL
premium selection

TOP PREIS LEISTUNG

Start Up Premium **7947**

NEU

STARTUP
premium



- Größen 56-17
Farben 08
14
16
56
17
140
35
16

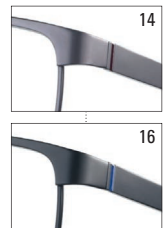

Farbe 08 Edelstahl, Federscharnier

STAINLESS STEEL
premium selection

TOP PREIS LEISTUNG

Start Up Premium **7946**

NEU

STARTUP
premium



STAINLESS STEEL
premium selection

Farbe 08 Edelstahl, Federscharnier

- Größen 59-17
Farben 08
12
16
59
17
140
36
22

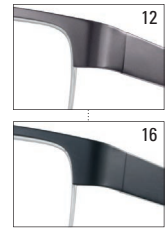

TOP PREIS LEISTUNG

Start Up Premium **7945**

NEU

STARTUP
premium



STAINLESS STEEL
premium selection

Farbe 12 Edelstahl, Federscharnier, Kunststoffbügel

- Größen 58-18
Farben 08
12
16
58
18
140
36
21

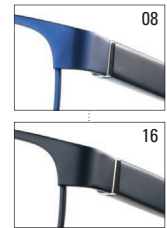

TOP PREIS LEISTUNG

Start Up Premium **7937**

STARTUP
premium



STAINLESS STEEL
premium selection

Farbe 14 Edelstahl, Federscharnier, Kunststoffbügel

- Größen 53-17
Farben 08
14
16
53
17
140
33
18

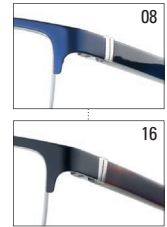

TOP PREIS LEISTUNG

Start Up Premium **7936**

STARTUP
premium



STAINLESS STEEL
premium selection

Farbe 16 Edelstahl, Federscharnier, Kunststoffbügel

- Größen 55-16
Farben 08
14
16
55
16
140
34
18

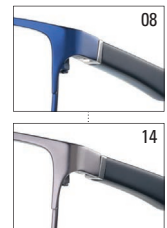

TOP PREIS LEISTUNG

Start Up Premium **7935**

STARTUP
premium



STAINLESS STEEL
premium selection

Farbe 08 Edelstahl, Federscharnier, Kunststoffbügel

- Größen 55-17
Farben 08
14
16
55
17
140
34
18

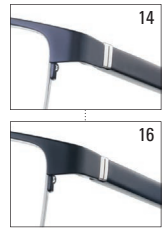

TOP PREIS LEISTUNG

Start Up Premium **7934**

STARTUP
premium



STAINLESS STEEL
premium selection

Farbe 16 Edelstahl, Federscharnier, Bohrbrille

- Größen 54-16
Farben 08
14
16
54
16
140
31
12

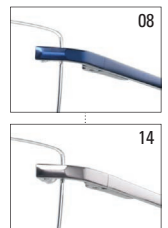

TOP PREIS LEISTUNG

Start Up Premium **7929**

STARTUP
premium



STAINLESS STEEL
premium selection

Farbe 16 Edelstahl, Federscharnier, Kunststoffbügel

- Größen 50-17
Farben 08
14
16
50
17
135
29
15

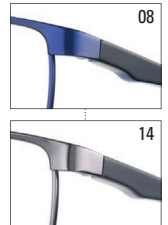

TOP PREIS LEISTUNG

Start Up Premium **7928**

STARTUP
premium



STAINLESS STEEL
premium selection

Farbe 16 Edelstahl, Federscharnier, Kunststoffbügel

- Größen 54-17
Farben 08
14
16
54
17
140
32
15

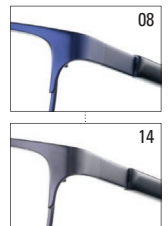

TOP PREIS LEISTUNG

Start Up Premium **7903**



STARTUP
premium

- Größen 58-18
 Farben 08
 12
 16
 58
 18
 140
 37
 21

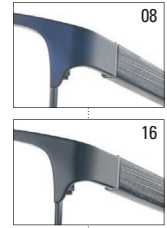

Farbe 12 Edelstahl, Federscharnier, Kunststoffbügel

STAINLESS STEEL
premium selection

TOP PREIS LEISTUNG

Start Up Premium **7902**



STARTUP
premium

- Größen 55-18
 Farben 08
 14
 16
 55
 18
 140
 37
 18

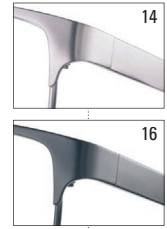

Farbe 08 Edelstahl, Federscharnier

STAINLESS STEEL
premium selection

TOP PREIS LEISTUNG

Start Up Premium **7901**



STARTUP
premium

- Größen 52-18
 Farben 08
 14
 16
 52
 18
 140
 31
 20

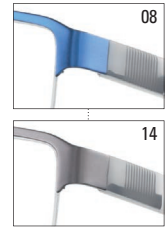

Farbe 16 Edelstahl, Federscharnier, Kunststoffbügel

STAINLESS STEEL
premium selection

TOP PREIS LEISTUNG

Start Up Premium **7900**



STARTUP
premium

- Größen 52-18
 Farben 08
 14
 52
 18
 140
 32
 17



Farbe 08 Edelstahl, Federscharnier, Kunststoffbügel

STAINLESS STEEL
premium selection

TOP PREIS LEISTUNG

Start Up Premium **7899**



STARTUP
premium

STAINLESS STEEL
premium selection

Farbe 16 Edelstahl, Federscharnier, Kunststoffbügel

- Größen 53-18
Farben 08
14
16
53
18
140
32
17

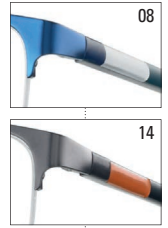

TOP PREIS LEISTUNG

Start Up Premium **7897**



STARTUP
premium

STAINLESS STEEL
premium selection

Farbe 16 Edelstahl, Federscharnier, Kunststoffbügel

- Größen 55-18
Farben 08
12
16
55
18
140
33
16

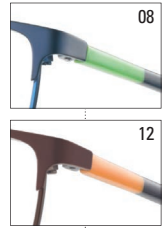

TOP PREIS LEISTUNG

Start Up Premium **7896**



STARTUP
premium

STAINLESS STEEL
premium selection

Farbe 14 Edelstahl, Federscharnier, Kunststoffbügel

- Größen 53-17
Farben 08
14
16
53
17
140
33
19

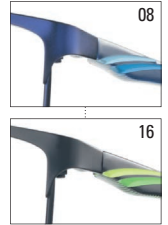

TOP PREIS LEISTUNG

Start Up Premium **7894**



STARTUP
premium

STAINLESS STEEL
premium selection

Farbe 16 Edelstahl

- Größen 55-17
Farben 15
16
55
17
145
37
14



TOP PREIS LEISTUNG

Start Up Premium **7892**

STARTUP
premium



STAINLESS STEEL
premium selection

Farbe 16 Edelstahl, Federscharnier, Kunststoffbügel

- Größen 57-19
Farben 08
12
16
57
19
140
36
20

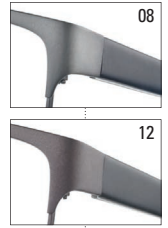

TOP PREIS LEISTUNG

Start Up Premium **7891**

STARTUP
premium



STAINLESS STEEL
premium selection

Farbe 08 Edelstahl, Federscharnier, Kunststoffbügel

- Größen 55-17
Farben 08
14
16
55
17
140
34
18

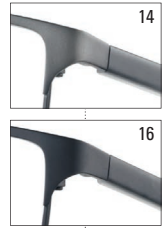

TOP PREIS LEISTUNG

Start Up Premium **7846**

STARTUP
premium



STAINLESS STEEL
premium selection

Farbe 14 Edelstahl, Federscharnier, Kunststoffbügel

- Größen 54-18
Farben 12
14
16
54
18
140
34
20

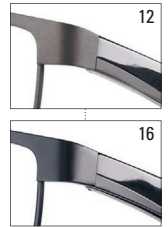

TOP PREIS LEISTUNG

Start Up Premium **7825**

STARTUP
premium



STAINLESS STEEL
premium selection

Farbe 16 Edelstahl, Federscharnier, Kunststoffbügel

- Größen 58-18
Farben 08
14
16
58
18
140
35
22

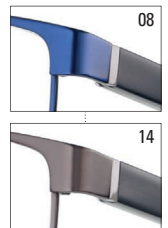

TOP PREIS LEISTUNG

Start Up Premium **6212**



STARTUP
premium

Größen 49-16

Farben 08

15

16

49

16

135

28

12



08



16

XTRA LIGHT ACETATE
premium selection

Farbe 15 Zelluloseacetat, Federscharnier

TOP PREIS LEISTUNG

Start Up Premium **6208**



STARTUP
premium

Größen 53-17

Farben 08

12

16

53

17

145

37

13



08



12

XTRA LIGHT ACETATE
premium selection

Farbe 16 Zelluloseacetat, Federscharnier

TOP PREIS LEISTUNG

Start Up Premium **6207**



STARTUP
premium

Größen 50-20

Farben 08

12

16

50

20

145

38

12



08



16

XTRA LIGHT ACETATE
premium selection

Farbe 12 Zelluloseacetat, Federscharnier

TOP PREIS LEISTUNG

Start Up Premium **6206**



STARTUP
premium

Größen 52-17

Farben 08

12

16

52

17

140

31

16



12



16

XTRA LIGHT ACETATE
premium selection

Farbe 08 Zelluloseacetat, Federscharnier

TOP PREIS LEISTUNG

Start Up Premium **6205**

STARTUP
premium



XTRA LIGHT ACETATE
premium selection

Farbe 16 Zelluloseacetat, Federscharnier

- Größen 54-18
Farben 08
12
16
54
18
140
38
12

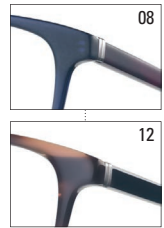

TOP PREIS LEISTUNG

Start Up Premium **6204**

STARTUP
premium



XTRA LIGHT ACETATE
premium selection

Farbe 12 Zelluloseacetat

- Größen 53-17
Farben 08
10
12
16
53
17
140
35
11

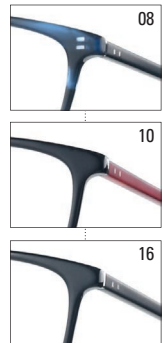

TOP PREIS LEISTUNG

Start Up Premium **6203**

STARTUP
premium



XTRA LIGHT ACETATE
premium selection

Farbe 08 Zelluloseacetat, Federscharnier

- Größen 54-17
Farben 08
10
12
16
54
17
140
31
13

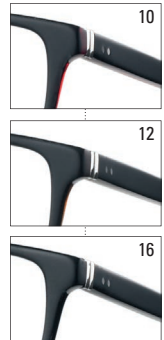

TOP PREIS LEISTUNG

Start Up Premium **6202**

STARTUP
premium



HAND MADE ACETATE
premium selection

Farbe 08 Zelluloseacetat, Federscharnier

- Größen 54-16
Farben 08
12
16
54
16
148
30
16

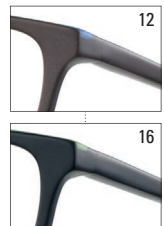

TOP PREIS LEISTUNG

Start Up Premium **6198**



STARTUP
premium

XTRA LIGHT ACETATE
premium selection

Farbe 16 Zelluloseacetat

Größen 55-16
Farben 08

- 12
- 14
- 16
- 55
- 16
- 140
- 39
- 11

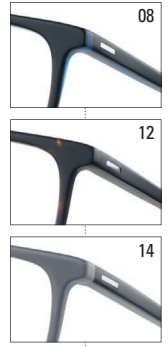

TOP PREIS LEISTUNG

Start Up Premium **6197**



STARTUP
premium

HAND MADE ACETATE
premium selection

Farbe 08 Zelluloseacetat, Federscharnier

Größen 54-16
Farben 08

- 15
- 16
- 54
- 16
- 140
- 31
- 17

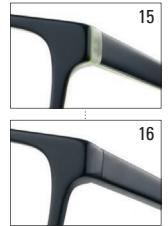

TOP PREIS LEISTUNG

Start Up Premium **6196**



STARTUP
premium

XTRA LIGHT ACETATE
premium selection

Farbe 12 Zelluloseacetat, Federscharnier

Größen 55-16
Farben 08

- 12
- 16
- 55
- 16
- 140
- 33
- 14

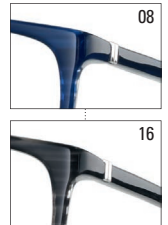

TOP PREIS LEISTUNG

Start Up Premium **6180**



STARTUP
premium

HAND MADE ACETATE
premium selection

Farbe 07 Zelluloseacetat, Federscharnier

Größen 50-16
Farben 07

- 08
- 16
- 50
- 16
- 135
- 32
- 16

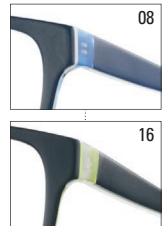

TOP PREIS LEISTUNG

Start Up Premium **6179**



STARTUP
premium

Größen 54-16

Farben 08

10

16

54

16

140

32

18



08



10

Farbe 16 Zelluloseacetat, Federscharnier

HAND MADE ACETATE
premium selection

TOP PREIS LEISTUNG

Start Up Premium **6178**



STARTUP
premium

Größen 55-17

Farben 12

15

16

55

17

140

36

16



12



16

Farbe 15 Zelluloseacetat, Federscharnier

HAND MADE ACETATE
premium selection

TOP PREIS LEISTUNG

Start Up Premium **6174**



STARTUP
premium

Größen 56-18

Farben 14

16

56

18

140

35

17



16

Farbe 14 Zelluloseacetat, Federscharnier, Metallbügel

HAND MADE ACETATE
premium selection

TOP PREIS LEISTUNG

Start Up Premium **5460**



STARTUP
premium

Größen 53-18

Farben 08

12

16

53

18

140

39

14



12



16

Farbe 08 Zelluloseacetat, Metallbügel

HAND MADE ACETATE
premium selection

TOP PREIS LEISTUNG

Start Up Premium **5459**

STARTUP
premium



XTRA LIGHT ACETATE
premium selection

Farbe 11 Zelluloseacetat, Metallbügel

Größen 49-19
Farben 10

- 11
- 12
- 16
- 49
- 19
- 140
- 40
- 13

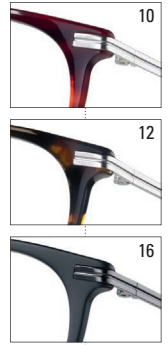

TOP PREIS LEISTUNG

Start Up Premium **5457**

STARTUP
premium



XTRA LIGHT ACETATE
premium selection

Farbe 10 Zelluloseacetat, Federscharnier

Größen 49-20
Farben 08

- 10
- 12
- 16
- 49
- 20
- 145
- 40
- 13

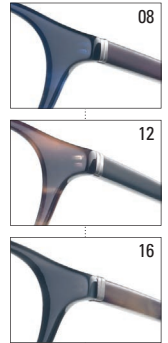

TOP PREIS LEISTUNG

Start Up Premium **5456**

STARTUP
premium



XTRA LIGHT ACETATE
premium selection

Farbe 12 Zelluloseacetat, Federscharnier

Größen 49-20
Farben 08

- 10
- 12
- 16
- 49
- 20
- 145
- 38
- 13

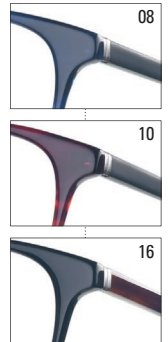

TOP PREIS LEISTUNG

Start Up Premium **5455**

STARTUP
premium



XTRA LIGHT ACETATE
premium selection

Farbe 08 Zelluloseacetat, Federscharnier

Größen 48-20
Farben 08

- 16
- 48
- 20
- 145
- 39
- 16

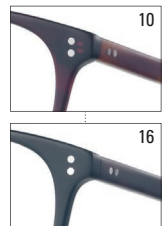

TOP PREIS LEISTUNG

Start Up Premium **5454**



STARTUP
premium

Größen 49-19

- Farben 08
10
16
49
19
140
40
15

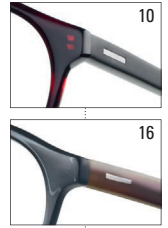

Farbe 08 Zelluloseacetat, Federscharnier

XTRA LIGHT ACETATE
premium selection

TOP PREIS LEISTUNG

Start Up Premium **5453**



STARTUP
premium

Größen 51-15

- Farben 08
12
15
16
51
15
135
38
15

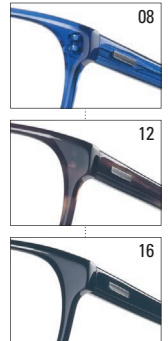

Farbe 15 Zelluloseacetat

XTRA LIGHT ACETATE
premium selection

TOP PREIS LEISTUNG

Start Up Premium **5445**



STARTUP
premium

Größen 51-17

- Farben 08
10
12
16
51
17
140
35
15

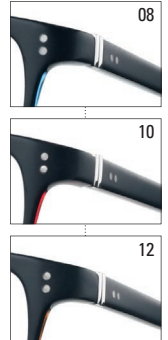

Farbe 16 Zelluloseacetat, Federscharnier

XTRA LIGHT ACETATE
premium selection

TOP PREIS LEISTUNG

Start Up Premium **5442**



STARTUP
premium

Größen 53-16

- Farben 10
12
14
16
53
16
140
41
12

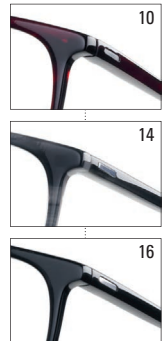

Farbe 12 Zelluloseacetat

XTRA LIGHT ACETATE
premium selection

TOP PREIS LEISTUNG

Start Up Premium **5430**



STARTUP
premium

XTRA LIGHT ACETATE
premium selection

Farbe 16 Zelluloseacetat, Federscharnier

Größen 53-17
Farben 08

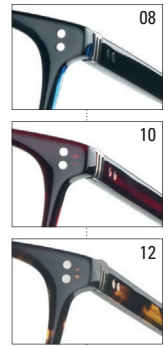
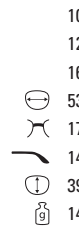

TOP PREIS LEISTUNG

Start Up Premium **5429**



STARTUP
premium

XTRA LIGHT ACETATE
premium selection

Farbe 10 Zelluloseacetat, Federscharnier

Größen 53-15
Farben 10

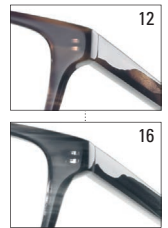
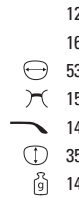

TOP PREIS LEISTUNG

Start Up Premium **5428**



STARTUP
premium

XTRA LIGHT ACETATE
premium selection

Farbe 12 Zelluloseacetat, Federscharnier

Größen 50-18
Farben 08

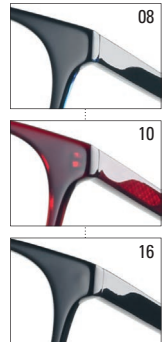

TOP PREIS LEISTUNG

Start Up Premium **5427**



STARTUP
premium

XTRA LIGHT ACETATE
premium selection

Farbe 16 Zelluloseacetat, Federscharnier

Größen 48-17
Farben 10

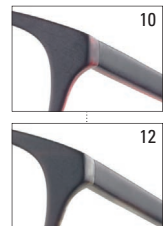
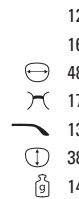

TOP PREIS LEISTUNG

Start Up Premium **5426**

STARTUP
premium



XTRA LIGHT ACETATE
premium selection

Farbe 10 Zelluloseacetat, Federscharnier

- Größen 50-17
Farben 10
15
50
17
135
32
11



TOP PREIS LEISTUNG

Start Up Premium **5423**

STARTUP
premium



HAND MADE ACETATE
premium selection

Farbe 12 Zelluloseacetat, Federscharnier

- Größen 53-16
Farben 12
14
16
53
16
135
35
19

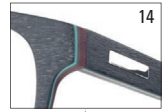

TOP PREIS LEISTUNG

Start Up Premium **5416**

STARTUP
premium



HAND MADE ACETATE
premium selection

Farbe 10 Zelluloseacetat, Federscharnier

- Größen 53-16
Farben 10
16
53
16
135
39
17



TOP PREIS LEISTUNG

Start Up Classic **8211**

STARTUP
classic



STAINLESS STEEL
premium selection

Farbe 14 Edelstahl, Federscharnier

- Größen 49-17
51-17
Farben 12
14
49/51
17
135
33/34
16



TOP PREIS LEISTUNG

Start Up Classic **8210**

NEU

STARTUP
classic



STAINLESS STEEL
premium selection

Farbe 10 Edelstahl, Federscharnier, Kunststoffbügel

- Größen 53-16
55-16
Farben 10
12
53/55
16
135
35/36
19



TOP PREIS LEISTUNG

Start Up Classic **8209**

NEU

STARTUP
classic



STAINLESS STEEL
premium selection

Farbe 12 Edelstahl, Federscharnier

- Größen 52-16
54-16
Farben 12
14
52/54
16
135
34/35
16



TOP PREIS LEISTUNG

Start Up Classic **8208**

STARTUP
classic



STAINLESS STEEL
premium selection

Farbe 10 Edelstahl, Federscharnier

- Größen 51-16
53-16
Farben 10
12
51/53
16
135
34/35
15



TOP PREIS LEISTUNG

Start Up Classic **8207**

STARTUP
classic



STAINLESS STEEL
premium selection

Farbe 12 Edelstahl, Federscharnier, Kunststoffbügel

- Größen 52-16
54-16
Farben 10
12
52/54
16
135
33/34
16



TOP PREIS LEISTUNG

Start Up Classic **8167**

STARTUP
classic



STAINLESS STEEL
premium selection

Farbe 12 Edelstahl, Federscharnier

- Größen 52-17
54-17
Farben 02
12
52/54
17
135
35/37
15



TOP PREIS LEISTUNG

Start Up Classic **8126**

STARTUP
classic



STAINLESS STEEL
premium selection

Farbe 12 Edelstahl, Federscharnier, Kunststoffbügel

- Größen 52-18
54-18
Farben 10
12
14
52/54
18
135
34/35
16



TOP PREIS LEISTUNG

Start Up Classic **7866**

STARTUP
classic



STAINLESS STEEL
premium selection

Farbe 12 Edelstahl, Federscharnier, Kunststoffbügel

- Größen 52-18
54-18
Farben 12
14
52/54
18
140
33/35
16



TOP PREIS LEISTUNG

Start Up Classic **7865**

STARTUP
classic



STAINLESS STEEL
premium selection

Farbe 14 Edelstahl, Federscharnier, Kunststoffbügel

- Größen 52-18
54-18
Farben 12
14
52/54
18
140
33/35
16



TOP PREIS LEISTUNG

Start Up Classic **7848**

STARTUP
classic



STAINLESS STEEL
premium selection

- Größen 56-18
Farben 12
14
56
18
140
37
16



12

Farbe 14 Edelstahl, Federscharnier, Kunststoffbügel, Vollsteg

TOP PREIS LEISTUNG

Start Up Classic **6199**

STARTUP
classic



HAND MADE ACETATE
premium selection

- Größen 52-19
54-19
56-19
Farben 12
14
52/54/56
19
140
35/37/40
16



12

Farbe 14 Zelluloseacetat, Federscharnier

TOP PREIS LEISTUNG

Start Up Classic **5452**

STARTUP
classic



HAND MADE ACETATE
premium selection

- Größen 52-16
Farben 10
12
14
52
16
135
36
15



10



14

Farbe 12 Zelluloseacetat, Federscharnier, Metallbügel

TOP PREIS LEISTUNG

Start Up Classic **5451**

STARTUP
classic



HAND MADE ACETATE
premium selection

- Größen 53-17
Farben 10
12
17
53
17
135
38
16



10



12

Farbe 17 Zelluloseacetat, Federscharnier, Metallbügel

TOP PREIS LEISTUNG

Start Up Classic **5450**

STARTUP
classic



HAND MADE ACETATE
premium selection

Farbe 10 Zelluloseacetat, Federscharnier

- Größen 52-17
Farben 10
12
14
52
17
135
36
15

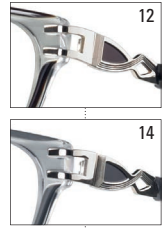

TOP PREIS LEISTUNG

Start Up Classic **5449**

STARTUP
classic



HAND MADE ACETATE
premium selection

Farbe 10 Zelluloseacetat, Federscharnier

- Größen 50-16
52-16
Farben 10
12
50/52
16
135
38/39
18



TOP PREIS LEISTUNG

Start Up Classic **5443**

STARTUP
classic



HAND MADE ACETATE
premium selection

Farbe 10 Zelluloseacetat, Federscharnier, Metallbügel

- Größen 52-17
Farben 10
12
52
17
135
37
19



TOP PREIS LEISTUNG

Start Up Classic **5422**

STARTUP
classic



HAND MADE ACETATE
premium selection

Farbe 10 Zelluloseacetat, Federscharnier, Metallbügel

- Größen 52-15
54-15
Farben 10
12
52/54
15
130
36/37
17



TOP PREIS LEISTUNG

Start Up Classic **5405**

STARTUP
classic



HAND MADE ACETATE
premium selection

Farbe 12 Zelluloseacetat, Federscharnier

- Größen 50-16
52-16
Farben 10
12
50/52
16
130
32/34
18



TOP PREIS LEISTUNG

Start Up Classic **5404**

STARTUP
classic



HAND MADE ACETATE
premium selection

Farbe 10 Zelluloseacetat, Federscharnier

- Größen 53-16
Farben 10
12
53
16
135
34
17



TOP PREIS LEISTUNG

Start Up Fashion **2532**

STARTUP
fashion



HAND MADE ACETATE
premium selection

Farbe 12 Zelluloseacetat, Federscharnier

- Größen 50-17
Farben 10
12
16
50
17
135
35
20



TOP PREIS LEISTUNG

Start Up Fashion **2531**

STARTUP
fashion



HAND MADE ACETATE
premium selection

Farbe 12 Zelluloseacetat, Federscharnier

- Größen 45-19
Farben 10
12
14
45
19
140
36
16



TOP PREIS LEISTUNG

Start Up Fashion **2530**

STARTUP
fashion



HAND MADE ACETATE
premium selection

Farbe 14 Zelluloseacetat, Federscharnier

- Größen 52-16
Farben 12
14
52
16
135
31
15



TOP PREIS LEISTUNG

Start Up Fashion **2529**

STARTUP
fashion



STAINLESS STEEL
premium selection

Farbe 08* Edelstahl, Bohrbrille

- Größen 50-17
Farben 08
10
14
15
50
17
138
30/32
09

- Größen 53-17
Farbe 16
53
17
138
32
09

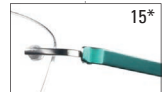

TOP PREIS LEISTUNG

Start Up Fashion **2511**

STARTUP
fashion



HAND MADE ACETATE
premium selection

Farbe 08 Zelluloseacetat

- Größen 54-17
Farben 08
14
16
54
17
140
31
19



TOP PREIS LEISTUNG

Start Up Readers **1186**

STARTUP
readers



XTRA LIGHT ACETATE
premium selection

Farbe 16 Zelluloseacetat, Federscharnier

- Größen 45-21
47-21
Farben 08
10
16
45/47
21
145
24/25
13



TOP PREIS LEISTUNG

Start Up Readers **1185**

STARTUP
readers



STAINLESS STEEL
premium selection

Farbe 14 Edelstahl, Federscharnier

- Größen 48-21
Farben 08
14
16
48
21
145
24
18

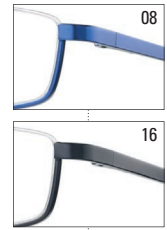

TOP PREIS LEISTUNG

Start Up Readers **1184**

STARTUP
readers



STAINLESS STEEL
premium selection

Farbe 17 Edelstahl, Federscharnier

- Größen 50-19
Farben 08
15
16
17
50
19
145
24
13

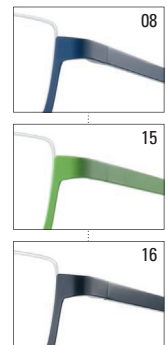

TOP PREIS LEISTUNG

Start Up Readers **1183**

STARTUP
readers



STAINLESS STEEL
premium selection

Farbe 08 Edelstahl, Federscharnier, Kunststoffbügel

- Größen 52-20
Farben 08
14
16
52
20
145
24
18

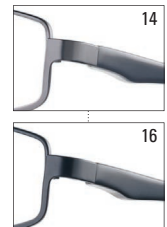

TOP PREIS LEISTUNG

Start Up Readers **1172**

STARTUP
readers



STAINLESS STEEL
premium selection

Farbe 14 Edelstahl, Federscharnier, Kunststoffbügel

- Größen 52-21
Farben 08
12
14
16
52
21
145
29
18

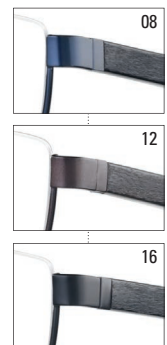

TOP PREIS LEISTUNG

Start Up Readers 1171

STARTUP
readers



STAINLESS STEEL
premium selection

- Größen 51-21
Farben 08
12
14
51
21
145
22
17

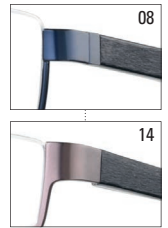

Farbe 12 Edelstahl, Federscharnier, Kunststoffbügel

TOP PREIS LEISTUNG

Start Up Readers 1166

STARTUP
readers



STAINLESS STEEL
premium selection

- Größen 52-21
Farben 02
14
16
52
21
145
26
17



Farbe 14 Edelstahl, Federscharnier, Kugelschreiber-Clip

TOP PREIS LEISTUNG

Start Up Readers 1150

STARTUP
readers



STAINLESS STEEL
premium selection

- Größen 51-20
Farben 08
14
16
51
20
145
22
18

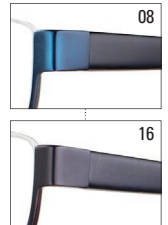

Farbe 14 Edelstahl, Federscharnier, Kunststoffbügel

TOP PREIS LEISTUNG

Start Up Readers 1149

STARTUP
readers



STAINLESS STEEL
premium selection

- Größen 52-21
Farben 08
14
16
52
21
145
26
18

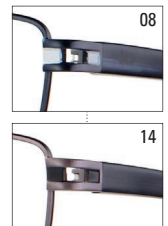

Farbe 16 Edelstahl, Federscharnier, Kunststoffbügel

TOP PREIS LEISTUNG

Start Up Readers **1114**

STARTUP
readers



- Größen 50-21
52-21
Farben 14
16
⊖ 50/52
⊗ 21
⌒ 145
Ⓢ 24/25
Ⓜ 16



Farbe 16 Federscharnier

TOP PREIS LEISTUNG

Start Up Readers **1072**

STARTUP
readers



- Größen 49-19
Farben 08
12
16
⊖ 49
⊗ 19
⌒ 145
Ⓢ 21
Ⓜ 10



Farbe 08 Federscharnier

TOP PREIS LEISTUNG

Start Up Readers **1052**

STARTUP
readers



- Größen 50-21
52-21
Farben 02
08
14
⊖ 50/52
⊗ 21
⌒ 145
Ⓢ 27/29
Ⓜ 13



Farbe 14 Federscharnier

TOP PREIS LEISTUNG

Start Up Readers **1041**

STARTUP
readers



- Größen 49-21
Farben 02
08
14
⊖ 49
⊗ 21
⌒ 145
Ⓢ 25
Ⓜ 12



Farbe 08 Federscharnier







TOP PREIS LEISTUNG

Start Up Basics **8206**

STARTUP
basics



Farbe 12 Federscharnier

| | | | |
|--------|--|---|----|
| Größen | 51-18 |  | 02 |
| | 53-18 | | |
| | 55-18 | | |
| Farben | 02 |  | 16 |
| | 12 | | |
| | 16 | | |
| |  51/53/55 | | |
| |  18 | | |
| |  135 | | |
| |  36/37/39 | | |
| |  18 | | |







TOP PREIS LEISTUNG

Start Up Basics **8205**

STARTUP
basics



Farbe 10 Federscharnier

| | | | |
|--------|--|---|----|
| Größen | 48-18 |  | 02 |
| | 50-18 | | |
| | 52-18 | | |
| Farben | 02 |  | 12 |
| | 10 | | |
| | 12 | | |
| |  48/50/52 | | |
| |  18 | | |
| |  135 | | |
| |  33/35/36 | | |
| |  18 | | |







TOP PREIS LEISTUNG

Start Up Basics **7933**

STARTUP
basics



Farbe 16 Federscharnier

| | | | |
|--------|--|---|----|
| Größen | 51-18 |  | 02 |
| | 53-18 | | |
| | 55-18 | | |
| Farben | 02 |  | 14 |
| | 14 | | |
| | 16 | | |
| |  51/53/55 | | |
| |  18 | | |
| |  140 | | |
| |  32/33/34 | | |
| |  18 | | |







TOP PREIS LEISTUNG

Start Up Basics **7932**

STARTUP
basics



Farbe 14 Federscharnier

| | | | |
|--------|--|---|----|
| Größen | 52-18 |  | 02 |
| | 54-18 | | |
| | 56-18 | | |
| Farben | 02 |  | 12 |
| | 12 | | |
| | 14 | | |
| | 16 | | |
| |  52/54/56 | | |
| |  18 | | |
| |  140 | | |
| |  36/38/39 | | |
| |  19 | | |



TOP PREIS LEISTUNG

Start Up Basics **7931**

STARTUP
basics



Farbe 02 Federscharnier

| | | | |
|--------|----------|---|----|
| Größen | 50-18 |  | 12 |
| | 52-18 | | |
| | 54-18 | | |
| Farben | 02 | | |
| | 12 |  | 14 |
| | 14 | | |
| | 16 | | |
| | 50/52/54 | | |
| | 18 | | |
| | 140 | | |
| | 32/34/36 |  | 16 |
| | 18 | | |



TOP PREIS LEISTUNG

Start Up Basics **7743**

STARTUP
basics



Farbe 14

| | | | |
|--------|-------|--|----|
| Größen | 50-18 |  | 01 |
| | 52-18 | | |
| Farben | 01 | | |
| | 02 | | |
| | 14 |  | 02 |
| | 16 | | |
| | 50/52 | | |
| | 18 | | |
| | 140 | | |
| | 32/33 |  | 16 |
| | 13 | | |

TOP PREIS LEISTUNG

Start Up Basics **7742**

STARTUP
basics



Farbe 16

| | | | |
|--------|-------|---|----|
| Größen | 52-18 |  | 01 |
| | 54-18 | | |
| Farben | 01 | | |
| | 02 | | |
| | 14 |  | 02 |
| | 16 | | |
| | 52/54 | | |
| | 18 | | |
| | 140 | | |
| | 34/35 |  | 14 |
| | 14 | | |

TOP PREIS LEISTUNG

Start Up Basics **6200**

STARTUP
basics



Farbe 14

| | | | |
|--------|-------|---|----|
| Größen | 52-18 |  | 12 |
| | 54-18 | | |
| Farben | 12 | | |
| | 14 | | |
| | 52/54 | | |
| | 18 | | |
| | 140 | | |
| | 35/36 | | |
| | 14 | | |

TOP PREIS LEISTUNG

Start Up Basics **5447**



STARTUP
basics

- Größen 52-17
54-17
Farben 10
12
17
52/54
17
135
36/38
14

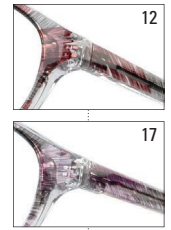

Farbe 10

TOP PREIS LEISTUNG

Start Up Basics **5444**



STARTUP
basics

- Größen 50-17
52-17
Farben 10
12
14
50/52
17
135
35/37
14

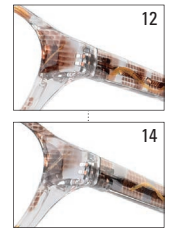

Farbe 10

TOP PREIS LEISTUNG

Start Up Basics **2504**



STARTUP
basics

- Größen 48-18
Farben 08
14
16
48
18
135
26
11

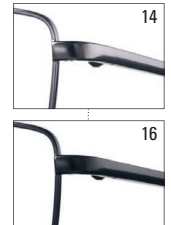

Farbe 08

TOP PREIS LEISTUNG

Start Up Basics **1182**



STARTUP
basics

- Größen 48-19
50-19
52-19
Farben 02
10
14
16
48/50/52
19
145
28/29/30
12

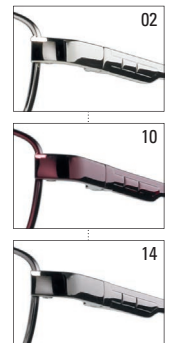

Farbe 16 Federscharnier

TOP PREIS LEISTUNG

Start Up Basics 1129

STARTUP
basics



Farbe 14

- Größen 47-21
49-21
Farben 02
12
14
16
47/49
21
145
26/27
13

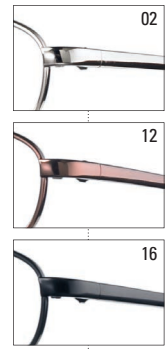

TOP PREIS LEISTUNG

Start Up Basics 1112

STARTUP
basics



Farbe 14 Federscharnier

- Größen 48-23
50-23
Farben 01
02
14
16
48/50
23
145
26/27
13

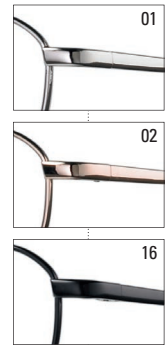

Aufsteller

DIN A5
2 Seiten
4-farbig



Flyer

DIN lang
2 Seiten
4/4-farbig

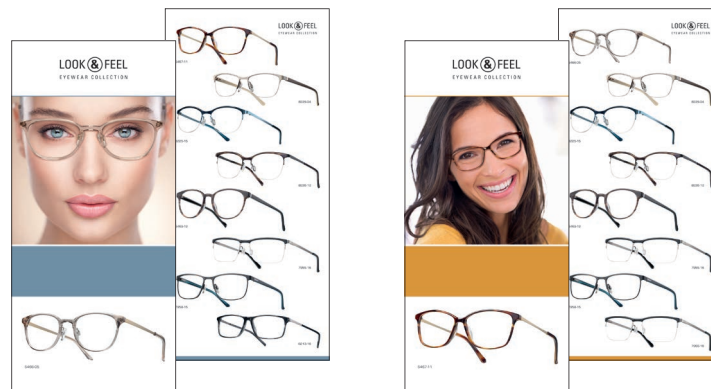



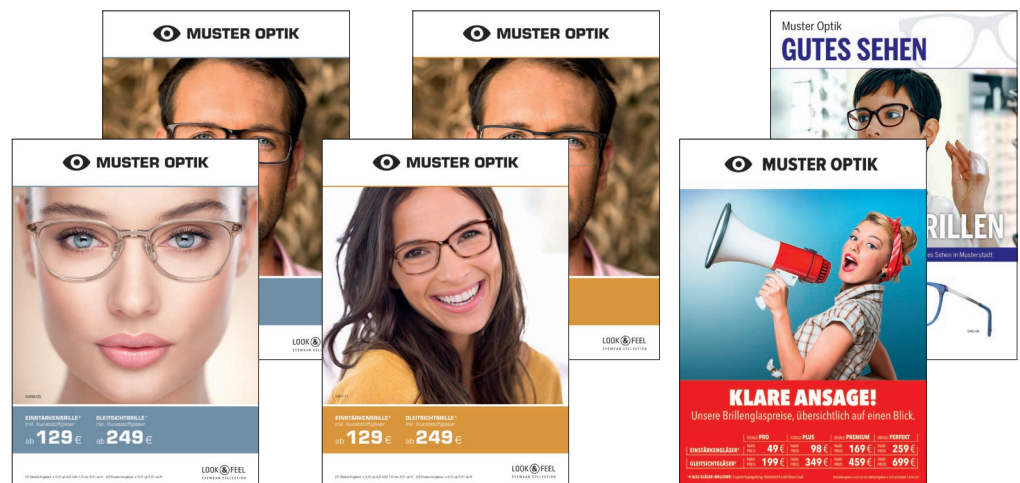

Imageanzeigen

DIN A5
4-farbig

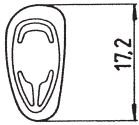
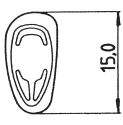
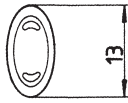

Sie haben keine Marketingmappe bekommen?

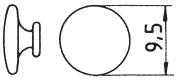
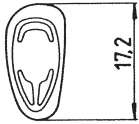
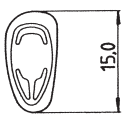
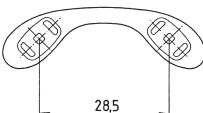
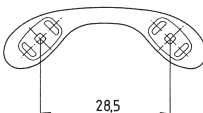
Fordern Sie Ihr Exemplar an unter: bestellung@binde-optik.de oder telefonisch 0571 / 28013 bei unserer Marketingexpertin Tanja Rautmann.

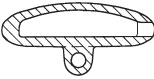
| Silicon-Pads | | | | |
|---|---|---|--|---|
| Click-System | Click-System | Click-System | Click-System | Mono Pad |
|  |  |  |  |  |
| Best.-Nr. 448 | Best.-Nr. 411 | Best.-Nr. 414 | Best.-Nr. 407 | Best.-Nr. 409 |
| Schraub-System | Schraub-System | Click-System | Schraub-System | Schraub-System |
|  |  |  |  |  |
| Best.-Nr. 449 | Best.-Nr. 412 | Best.-Nr. 447 | Best.-Nr. 445 | Best.-Nr. 465 |
| Air Active (145 mm) | | | | |
| Schraub-System | | | | |
|  | | | | |
| Best.-Nr. 471 | | | | |

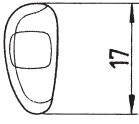
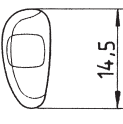
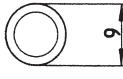
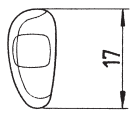
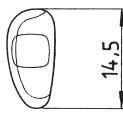
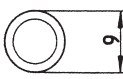
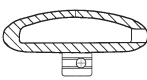
| PVC-Pads (Phthalat-Frei) | | | | |
|---|---|---|--|---|
| Click-System | Click-System | Click-System | Schraub-System | Schraub-System |
|  |  |  |  |  |
| Best.-Nr. 405 | Best.-Nr. 400 | Best.-Nr. 422 | Best.-Nr. 410 | Best.-Nr. 401 |
| Schraub-System | Air Active (130 mm) | | | |
|  |  | | | |
| Best.-Nr. 423 | Best.-Nr. 472 | | | |

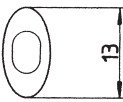
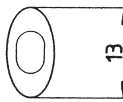







| Titan-Pads (pur Titan) | |
|---|---|
| Click-System | Schraub-System |
|  |  |
| Best.-Nr. 462 | Best.-Nr. 463 |

Sortiment (Pads)

Folgende Pads bieten wir Ihnen als Sortiment zum günstigeren Einkaufspreis an (1 VE: 5 Paar Pads):

(Silicon - Pads) 407; 409; 411; 412; 414 ; 448; 449
 (Esprit - Pads) 400; 401; 405; 410; 422; 423

Bitte sortieren Sie selbst.

| Cellenden (1 Pack: 10 Stück) | | | | |
|------------------------------|---|------------|-------|---------|
| Best.-Nr. | Abbildung | Farbe | Länge | Bohrung |
| 316 |  | schwarz | 65 mm | 1,5 mm |
| 317 |  | braun | 65 mm | 1,5 mm |
| 320 |  | braun | 75 mm | 1,5 mm |
| 321 |  | schwarz | 75 mm | 1,5 mm |
| 324 |  | schwarz | 70 mm | 1,9 mm |
| 326-12 |  | braun | 63 mm | 1,5 mm |
| 326-14 |  | Titan grau | 63 mm | 1,5 mm |
| 327-12 |  | braun | 65 mm | 1,5 mm |
| 327-14 |  | Titan grau | 65 mm | 1,5 mm |

| Zubehör | | | |
|-----------------|--|-------------|-----------|
| Beschreibung | Abbildung | Länge/Menge | Best.-Nr. |
| Etikettenträger |  | 500 Stück | 377 |

| Brillenkordeln | |
|---|--|
| Abbildung | Beschreibung |
|  | - 2 = schwarz - 3 = bunt-sortiert 1 Verpackungseinheit: 12 Stück |
| | Best.-Nr. 956 |

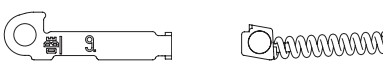
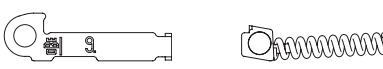
| OBE-Federscharnier (flexUno) | | | |
|--|--|----------|-----------|
| Beschreibung | Abbildung | Menge | Best.-Nr. |
| Einsatz + Feder, 3.0 Metallbügel BI 4266, 4267, 4268, 4269, 4270 |  | 10 Stück | 82 |
| Einsatz + Feder, 2.7 Kunststoffbügel BI 4271, 4272, 4273, 4277, 4278, 4279, 4280, 4281, 4282 |  | 10 Stück | 83 |

ZERTIFIKAT

zur Biokompatibilität

Allergie Schutzlackierung für Brillengestelle (VC-80075 Dreikomponenten-Klarlack)

Passive Oberflächenveredelung durch

Binde Optik GmbH & Co. KG
Postfach 2160 · D-32378 Minden

Prüfungen zur Biokompatibilität

Wir bestätigen, daß die folgenden Prüfungen zur Bestimmung der Biokompatibilität gemäß der internationalen Norm DIN EN ISO 10993-1: 1998 "Biologische Beurteilung von Medizinprodukten - Teil 1: Beurteilung und Prüfung" durchgeführt wurden:

1. Zytotoxizitätsprüfung

Die potentielle zelltoxische Wirkung der mit VC-80075 Dreikomponenten-Klarlack behandelten Neusilber Prüflinge wurde im Vergleich zu nicht-lackierten Prüflingen aus Neusilber in-vitro gemäß ISO 10993-5: 1992 im Wachstumshemmtest untersucht. Der unverdünnte Materialextrakt der lackierten Prüflinge löste eine Wachstumshemmung von 43 % aus, die in der nächsten Verdünnungsstufe nicht mehr nachweisbar war. Der unverdünnte Extrakt der nicht-lackierten Prüflinge verursachte eine vollständige Wachstumshemmung.

2. Sensibilisierungsprüfung

Die potentielle allergieauslösende Wirkung der mit VC-80075 Dreikomponenten-Klarlack behandelten Neusilber Prüflinge wurde in-vivo gemäß ISO 10993-10: 1995 im Maximierungstest nach Magnusson & Kligman untersucht. Die Prüfung ergab keine Hinweise auf sensibilisierende Eigenschaften.

mdt medical device testing GmbH
Schloßstraße 17 · 88416 Ochsenhausen



Dr. Dieter R. Dannhorn, 12.08.1999

Allergieschutzbeschichtung

- › Allergieschutzbeschichtung gegen Nickelaustritt für alle Metallfassungen. (Auch für Fremdfassungen)
- › Die Farbechtheit der Fassung(en) bleibt weitgehend erhalten.
- › Besteht ohne Probleme den Schweißtest der DIN EN ISO 12870.
- › Diese Beschichtung erfüllt die DIN EN ISO 10993. (Biologische Beurteilung von Medizinprodukten)
- › Die aufgetragene Beschichtung wird auf Dichtigkeit kontrolliert. Nickeltest nach CR 12471 (screening-test).
- › Beginnend mit dem Tag der Auslieferung hält die Allergieschutzbeschichtung mindestens 12 Monate.

Hinweis:

Bei Einsendung der Brillenfassung(en), entfernen Sie bitte vorher alle nichtmetallischen Teile (Pad's, Cellenden, Celloberteile, usw.). Steg-, Bügel- und Bohrbrillenschrauben nicht entfernen! Bitte säubern Sie vorher die Fassung(en) von Schmutz und Grünspan.

Bei Fremdfabrikaten gilt:

Für entstandene Schäden beim Demontieren der Brillenfassung(en) übernehmen wir keine Haftung. Bitte geben Sie bei jeder Fassung die Modelldaten an (Hersteller, Modell-Nr., Farb-Nr. und Größe). Brillenfassungen, die mit einem Nagel- oder Autolack nachbehandelt sind, können wir nicht beschichten.

Rechtlicher Hinweis (Deutschland)

Das Medizinproduktegesetz verpflichtet den Augenoptiker (Sonderanfertiger), die von uns gegebenen Hinweise bezüglich der Produktinformation und Pflegehinweis zu beachten und auch an den Endverbraucher (Patient) weiterzugeben. Besonders ist darauf zu achten, dass unsere Produkte (Brillenfassungen) nicht mit Lösungsmitteln wie Spiritus, Aceton, Salmiaklösungen oder ähnliche Stoffe gereinigt werden. Dies kann zu allergischen oder toxischen Reaktionen führen.

Grundsätzlich ist der Augenoptiker (Sonderanfertiger) auch für die Beratung und Auswahl der „richtigen Brille“ für den Endkunden (Patient), bezüglich dessen allergischen Vorgeschichte verantwortlich. Bei schwangeren oder stillenden Frauen ist eine besondere Aufmerksamkeit notwendig. Bei der Verwendung von fremden oder falschen Ersatzteilen (z. B. Nasenstege), übernimmt Firma Binde Optik keine Haftung.

Pflegehinweis für Brillengestelle & Patienteninformation:

Bitte achten Sie darauf, die Brillenfassungen nicht mit aggressiven chemischen Reinigungs- oder Desinfektionsmitteln in Kontakt zu bringen. Insbesondere sollten Aceton, Nitroverdünnung, Terpentinersatz, Waschbenzin, Essigessenz, Salmiaklösung und chlorhaltige Reinigungsmittel vermieden werden. Solche Substanzen können das Farbdesign der Brillenfassung, die biologischen Eigenschaften von Kunststofffassungen und die antiallergische Schutzbeschichtung von Metallfassungen angreifen.

Cleaning of Optical Frames & Informations:

Please take care not to treat optical frames with aggressive chemical cleaning or disinfecting agents such as acetone, cellulose thinner, turpentine-like diluting agents, benzene, acetic acid, ammonium chloride or other chlorous chemicals. Such substances may damage the colour design or may adversely affect the biocompatibility of the plastic frames or may remove the allergy seal of metal frames.

Verkaufs-, Lieferungs- und Zahlungsbedingungen der Walter Binde Optik GmbH & Co. KG

1. Allgemeine Bestimmungen

Die nachstehenden Bedingungen werden sämtlichen Lieferungen und Leistungen zugrunde gelegt. Anders lautende Allgemeine Geschäftsbedingungen des Kunden, Abweichungen oder mündliche Nebenabreden sind nur verbindlich, wenn Sie entweder zwingendem Recht entsprechen oder von uns ausdrücklich schriftlich bestätigt worden sind. Der Vertrag bleibt auch im Fall der Unwirksamkeit einzelner Bestimmungen in seinen übrigen Teilen verbindlich. Etwaige unwirksame Bestimmungen sind von den Vertragspartnern im Rahmen des Zumutbaren nach Treu und Glauben durch solche Regelungen zu ersetzen, die dem wirtschaftlichen Zweck des Vertrages am besten gerecht werden, ohne dass dadurch der Vertragsinhalt wesentlich geändert wird. Das gleiche gilt, falls es an einer ausdrücklichen Regelung für einen regelungsbedürftigen Sachverhalt fehlt. Stellt das Festhalten an dem Vertrag eine unzumutbare Härte für eine Vertragspartei dar, so ist dieser unwirksam.

2. Vertrag und Umfang der Leistung

Unsere Angebote sind freibleibend. Aufträge sind für uns erst verbindlich, wenn sie von uns schriftlich bestätigt worden sind. Fehlt eine schriftliche Bestätigung, wird diese durch die erteilte Rechnung oder Lieferschein ersetzt. Maßgeblich für den Umfang der geschuldeten Leistung ist allein unsere schriftliche Bestätigung. Katalogangaben, Abbildungen, Produktbeschreibungen, etc. sind lediglich als annähernd zu betrachten. Unwesentliche und/oder handelsübliche Abweichungen, wie z.B. auch solche im Rahmen der ständigen Produktverbesserung, die die Verwendbarkeit nicht beeinträchtigen und dem Kunden zumutbar sind, bleiben vorbehalten.

3. Preise und Zahlungsbedingungen

Die Preise verstehen sich in Euro ab Werk Minden ausschließlich Verpackung zzgl. der jeweils geltenden Umsatzsteuer. Zahlungen haben innerhalb von 30 Tagen ab Rechnungsdatum ohne Abzug zu erfolgen, bei Zahlung innerhalb 10 Tagen ab Rechnungsdatum abzüglich 2 % Skonto. Die Zahlungen sind frei Zahlstelle des Lieferers zu leisten. Bei Verträgen mit Unternehmern können wir bei schuldhafter Überschreitung der Zahlungsfrist Verzugszinsen in Höhe von 8 % über dem jeweils geltenden Basiszinssatz nach § 247 BGB verlangen. Kommt der Kunde mit einem nicht unerheblichen Teil der Zahlung in Verzug oder gehen Schecks oder Wechsel zu Protest oder entfallen die Voraussetzungen für eine Kreditgewährung, so werden unsere sämtlichen Forderungen gegen ihn zur sofortigen Zahlung fällig. Dies gilt auch für ursprünglich gestundete Rechnungen sowie später fällige Wechsel oder Schecks. Verschlechtert sich die Vermögenslage des Kunden nach Vertragsabschluss erheblich oder wird eine bereits bestehende Kreditunwürdigkeit erst nach Vertragsabschluss erkennbar, sind wir berechtigt, die noch nicht ausgeführten Lieferungen zu verweigern bzw. angemessene Vorauszahlungen oder Sicherheitsleistungen zu verlangen, wenn die Gegenleistung gefährdet ist. Der Kunde kann nur mit solchen Forderungen aufrechnen, die unbestritten oder rechtskräftig festgestellt sind. Ein Zurückbehaltungsrecht kommt für ihn nur insoweit in Betracht, als es auf Ansprüchen aus demselben Vertragsverhältnis beruht.

4. Lieferung

Lieferfristen beginnen mit Vertragsschluss und können verbindlich nur schriftlich vereinbart werden. Die Lieferfrist verlängert sich angemessen, wenn der Käufer erforderliche und/oder vereinbarte Mitwirkungshandlungen verzögert oder unterläßt oder die vereinbarten Zahlungsbedingungen nicht einhält. Entsprechendes gilt bei Maßnahmen bei Eintritt unvorhergesehener Hindernisse, die außerhalb unserer Sphäre liegen, z. B. Lieferverzögerung eines Vorlieferanten, Verkehrs- und Betriebsstörungen, Werkstoff- oder Energiemangel, etc. Auch vom Kunden veranlaßte Änderungen der zu liefernden Ware führen zu einer angemessenen Verlängerung der Lieferfrist. Zu Teillieferungen sind wir berechtigt, soweit diese dem Kunden zumutbar sind. Bei einer länger andauernden Nichtverfügbarkeit der Leistung behalten wir uns den Rücktritt vom Vertrag vor.

5. Versand und Gefahrübergang

Bei Versendung der Ware geht die Gefahr des zufälligen Untergangs und der zufälligen Verschlechterung der Sache auf den Kunden über, wenn die Ware an die den Transport ausführende Person übergeben wird oder wenn die Ware zwecks Versendung unser Lager verlassen hat. Soweit nichts anderes vereinbart ist, steht die Versandart, der Transportweg, etc. in unserem Ermessen. Kosten für abweichende Kundenwünsche gehen zu dessen Lasten. Eine zusätzliche Versicherung gegen Transportschäden erfolgt nur auf Anordnung und Kosten des Kunden. Bitte beachten: Unfreie Pakete und Päckchen werden von der Firma Binde Optik GmbH & Co. KG nicht angenommen.

6. Sachmängelhaftung

Für die Verjährung von Ansprüchen wegen Sachmängel gelten die gesetzlichen Vorschriften. Liegen Mängel vor, kann der Kunde primär Nacherfüllung gemäß § 439 BGB verlangen. Wir sind berechtigt, zwischen der Beseitigung des Mangels und der Lieferung einer mangelfreien Sache zu wählen. Bitte beachten: Gewährleistungsansprüche sind zunächst auf zweimaliger Nacherfüllung beschränkt, wobei die Firma Binde Optik GmbH & Co. KG Kenntnis von der Nacherfüllung haben muss. Bei Fehlschlägen der Nacherfüllung besteht ein Anspruch auf Rücktritt vom Kaufvertrag. Mängelansprüche bestehen nicht bei einer unerheblichen Abweichung von der vereinbarten Beschaffenheit, bei einer unerheblichen Beeinträchtigung der Brauchbarkeit, bei natürlicher Abnutzung oder Schäden, die nach dem Gefahrübergang infolge fehlerhafter oder nachlässiger Behandlung, übermäßiger Beanspruchung, unsachgemäßem Gebrauch, mangelnder Pflege, etc. entstehen. Werden vom Kunden oder von Dritten unsachgemäß Änderungen oder Bearbeitungen vorgenommen, so bestehen für diese und die daraus entstehenden Folgen ebenfalls keine Mängelansprüche. Wir haften nach den gesetzlichen Bestimmungen auf Schadensersatz, sofern der Kunde Ansprüche geltend macht, die auf Arglist, Vorsatz oder grober Fahrlässigkeit unsererseits, auf Verletzung des Lebens, des Körpers oder der Gesundheit oder auf der Verletzung vertragswesentlicher Pflichten beruhen. Wird uns keine vorsätzliche oder grob fahrlässige Vertragsverletzung angelastet, haften wir nur auf den Ersatz des typischen vorhersehbaren Schadens. Eine Haftung für Schäden, die nicht am Liefergegenstand entstanden sind, scheidet aus, es sei denn, es handelt sich um Verletzungen des Lebens, des Körpers oder der Gesundheit, die aus einer von uns begangenen fahrlässigen Pflichtverletzung oder einer vorsätzlichen oder fahrlässigen Pflichtverletzung unseres gesetzlichen Vertreters oder Erfüllungsgehilfen beruhen. Im Übrigen ist die Schadensersatzhaftung ausgeschlossen.

7. Eigentumsvorbehalt

Wir behalten uns das Eigentum an sämtlichen gelieferten Waren bis zur vollständigen Bezahlung vor. Im Rechtsverkehr mit Kaufleuten gilt der Eigentumsvorbehalt auch, bis sämtliche, auch künftige und bedingte Forderungen aus der Geschäftsverbindung erfüllt sind. Zur Weiterveräußerung ist der Kunde nur im ordnungsgemäßen Geschäftsgang berechtigt, wobei er seine Forderung aus der Weiterveräußerung bereits jetzt an uns abtritt. Wir nehmen die Abtretung an. Zur Einziehung dieser Forderung bleibt der Kunde auch nach der Abtretung ermächtigt. Unsere Befugnis, die Forderung selbst einzuziehen, bleibt hiervon unberührt. Wir verpflichten uns, die Forderung nicht selbst einzuziehen, solange der Kunde seinen Zahlungsverpflichtungen vertragsgemäß nachkommt. Der Kunde ist nicht berechtigt, unter Eigentumsvorbehalt stehende Ware zu verpfänden oder zur Sicherheit zu übereignen. Einwirkungen Dritter auf diese Waren, insbesondere Pfändungen, sind uns unverzüglich mitzuteilen. Die Befugnis zur Weiterveräußerung kann von uns widerrufen werden, falls der Kunde seinen Verpflichtungen aus dem Vertrag nicht ordnungsgemäß nachkommt. Auf Verlangen des Kunden sind wir verpflichtet, eingeräumte Sicherheiten nach unserer Wahl freizugeben, soweit deren Wert unsere Forderungen um mehr als 10 % übersteigt.

8. Rückgriff des Unternehmers

Verkauft der Kunde die neu hergestellte Ware im Rahmen seines gewerblichen Betriebes an einen Verbraucher weiter und musste er diese Ware als Folge ihrer Mangelhaftigkeit zurücknehmen oder minderte der Verbraucher den Kaufpreis, so bedarf es für die Geltendmachung der Mängelansprüche des Kunden uns gegenüber keiner Fristsetzung. Der Kunde kann in dem Fall von uns Ersatz der Aufwendungen verlangen, die er im Verhältnis zum Verbraucher zu tragen hatte, wenn der vom Verbraucher geltend gemachte Mangel bereits bei Übergang der Gefahr auf den Kunden vorhanden war. Im Rahmen dieses Unternehmerückgriffs hat der Kunde keinen Anspruch auf Schadensersatz.

9. Sonstige Bestimmungen

Rücksendungen aus Auswahlendungen werden nur innerhalb von 14 Tagen akzeptiert. Die Ware muss original verpackt und in einem einwandfreien Zustand sein. Produktänderungen (Preise, Modelle, Farben) sind jederzeit über die Homepage (www.Binde-Optik.de) abrufbar. Produktinformationen bezüglich Material und Verträglichkeit werden grundsätzlich nur schriftlich beantwortet. Bitte beachten: Unfreie Pakete und Päckchen werden von der Firma Binde Optik GmbH & Co. KG nicht angenommen.

10. Abschließende Bestimmungen

Ist der Kunde Kaufmann, juristische Person des öffentlichen Rechts oder ein öffentlichrechtliches Sondervermögen, ist Gerichtsstand für alle sich aus dem Vertragsverhältnis ergebenden Streitigkeiten der für unseren Firmensitz zuständige Gerichtsort. Erfüllungsort ist Minden/Westfalen. Auf alle Verträge findet deutsches Recht Anwendung. „Verbraucher“ im Sinne dieser Bestimmungen ist gemäß § 13 BGB jede natürliche Person, die das Geschäft zu einem Zweck abschließt, der weder ihrer gewerblichen noch ihrer selbstständigen beruflichen Tätigkeit zugerechnet werden kann.

Sitz der KG: Minden, HRA 3533 Bad Oeynhausen

Pers. haftende Gesellschafterin: Binde-Beteiligungs-GmbH Minden, HRB 5095 Bad Oeynhausen,

Geschäftsführer: Jörn Binde, Walter Koenemann

| Art.-Nr. | Seite | Art.-Nr. | Seite | Art.-Nr. | Seite | Art.-Nr. | Seite | Art.-Nr. | Seite | Art.-Nr. | Seite |
|----------|-------|----------|-------|----------|-------|----------|-------|----------|-------|----------|-------|
| 511 | 52 | 3110 | 48 | 5468 | 12 | 7848 | 75 | 7948 | 59 | 8209 | 73 |
| 512 | 52 | 3111 | 48 | 5469 | 12 | 7852 | 27 | 7949 | 19 | 8210 | 73 |
| 529 | 51 | 3112 | 48 | 5470 | 12 | 7853 | 26 | 7950 | 19 | 8211 | 72 |
| 535 | 51 | 3113 | 48 | 6163 | 34 | 7856 | 26 | 7951 | 19 | 8212 | 5 |
| 1041 | 81 | 4257 | 47 | 6164 | 34 | 7860 | 40 | 7952 | 19 | 8213 | 5 |
| 1052 | 81 | 4266 | 47 | 6166 | 33 | 7862 | 39 | 7953 | 18 | 8214 | 5 |
| 1072 | 81 | 4267 | 46 | 6167 | 33 | 7865 | 74 | 7954 | 18 | 8215 | 57 |
| 1112 | 85 | 4268 | 46 | 6168 | 33 | 7866 | 74 | 7955 | 18 | 8216 | 57 |
| 1114 | 81 | 4270 | 46 | 6169 | 33 | 7878 | 26 | 7956 | 18 | 8217 | 57 |
| 1129 | 85 | 4271 | 46 | 6174 | 68 | 7881 | 26 | 7957 | 17 | 8219 | 57 |
| 1143 | 56 | 4277 | 45 | 6178 | 68 | 7882 | 25 | 7958 | 17 | 8220 | 35 |
| 1149 | 80 | 4278 | 45 | 6179 | 68 | 7883 | 25 | 7959 | 17 | 8221 | 35 |
| 1150 | 80 | 4279 | 45 | 6180 | 67 | 7884 | 39 | 7960 | 17 | 8222 | 35 |
| 1155 | 56 | 4280 | 45 | 6181 | 32 | 7888 | 25 | 8102 | 38 | 8225 | 5 |
| 1163 | 56 | 4281 | 44 | 6182 | 32 | 7891 | 64 | 8126 | 74 | 8226 | 4 |
| 1165 | 56 | 4282 | 44 | 6183 | 32 | 7892 | 64 | 8139 | 11 | 8227 | 4 |
| 1166 | 80 | 5404 | 77 | 6184 | 32 | 7894 | 63 | 8140 | 11 | 8228 | 4 |
| 1168 | 55 | 5405 | 77 | 6185 | 31 | 7896 | 63 | 8147 | 11 | 8229 | 4 |
| 1169 | 55 | 5406 | 16 | 6186 | 31 | 7897 | 63 | 8148 | 38 | 8230 | 35 |
| 1170 | 55 | 5413 | 16 | 6187 | 31 | 7899 | 63 | 8150 | 37 | 8231 | 3 |
| 1171 | 80 | 5414 | 16 | 6188 | 31 | 7900 | 62 | 8151 | 37 | 8232 | 3 |
| 1172 | 79 | 5416 | 72 | 6190 | 30 | 7901 | 62 | 8152 | 37 | 8234 | 3 |
| 1173 | 55 | 5422 | 76 | 6191 | 30 | 7902 | 62 | 8153 | 11 | 8235 | 3 |
| 1174 | 54 | 5423 | 72 | 6192 | 30 | 7903 | 62 | 8155 | 10 | | |
| 1175 | 54 | 5426 | 72 | 6193 | 30 | 7904 | 25 | 8156 | 10 | | |
| 1176 | 54 | 5427 | 71 | 6194 | 29 | 7905 | 24 | 8158 | 10 | | |
| 1177 | 54 | 5428 | 71 | 6196 | 67 | 7908 | 24 | 8159 | 10 | | |
| 1178 | 53 | 5429 | 71 | 6197 | 67 | 7909 | 24 | 8160 | 9 | | |
| 1179 | 53 | 5430 | 71 | 6198 | 67 | 7910 | 24 | 8165 | 59 | | |
| 1180 | 53 | 5431 | 16 | 6199 | 75 | 7913 | 23 | 8166 | 59 | | |
| 1181 | 53 | 5432 | 15 | 6200 | 83 | 7914 | 23 | 8167 | 74 | | |
| 1182 | 84 | 5434 | 15 | 6202 | 66 | 7915 | 23 | 8168 | 9 | | |
| 1183 | 79 | 5435 | 15 | 6203 | 66 | 7917 | 23 | 8170 | 9 | | |
| 1184 | 79 | 5437 | 15 | 6204 | 66 | 7918 | 22 | 8172 | 9 | | |
| 1185 | 79 | 5439 | 14 | 6205 | 66 | 7919 | 22 | 8174 | 8 | | |
| 1186 | 78 | 5440 | 14 | 6206 | 65 | 7920 | 22 | 8175 | 8 | | |
| 2504 | 84 | 5441 | 14 | 6207 | 65 | 7923 | 22 | 8177 | 8 | | |
| 2511 | 78 | 5442 | 70 | 6208 | 65 | 7924 | 39 | 8178 | 8 | | |
| 2529 | 78 | 5443 | 76 | 6209 | 29 | 7925 | 39 | 8179 | 7 | | |
| 2530 | 78 | 5444 | 84 | 6210 | 29 | 7926 | 21 | 8183 | 58 | | |
| 2531 | 77 | 5445 | 70 | 6211 | 29 | 7928 | 61 | 8186 | 37 | | |
| 2532 | 77 | 5447 | 84 | 6212 | 65 | 7929 | 61 | 8187 | 36 | | |
| 2880 | 43 | 5449 | 76 | 6213 | 28 | 7931 | 83 | 8188 | 36 | | |
| 2887 | 43 | 5450 | 76 | 6214 | 28 | 7932 | 82 | 8189 | 36 | | |
| 2889 | 43 | 5451 | 75 | 6215 | 28 | 7933 | 82 | 8190 | 36 | | |
| 2897 | 42 | 5452 | 75 | 6216 | 28 | 7934 | 61 | 8191 | 7 | | |
| 2899 | 42 | 5453 | 70 | 7742 | 83 | 7935 | 61 | 8192 | 7 | | |
| 2903 | 42 | 5454 | 70 | 7743 | 83 | 7936 | 60 | 8194 | 7 | | |
| 2904 | 42 | 5455 | 69 | 7746 | 41 | 7937 | 60 | 8195 | 6 | | |
| 3100 | 51 | 5456 | 69 | 7752 | 41 | 7938 | 21 | 8197 | 6 | | |
| 3101 | 51 | 5457 | 69 | 7753 | 41 | 7939 | 21 | 8199 | 58 | | |
| 3102 | 50 | 5459 | 69 | 7759 | 40 | 7940 | 21 | 8200 | 58 | | |
| 3103 | 50 | 5460 | 68 | 7788 | 40 | 7941 | 20 | 8201 | 58 | | |
| 3104 | 50 | 5461 | 14 | 7792 | 27 | 7942 | 20 | 8202 | 6 | | |
| 3105 | 50 | 5463 | 13 | 7798 | 40 | 7943 | 20 | 8203 | 6 | | |
| 3106 | 49 | 5464 | 13 | 7800 | 27 | 7944 | 20 | 8205 | 82 | | |
| 3107 | 49 | 5465 | 13 | 7808 | 27 | 7945 | 60 | 8206 | 82 | | |
| 3108 | 49 | 5466 | 13 | 7825 | 64 | 7946 | 60 | 8207 | 73 | | |
| 3109 | 49 | 5467 | 12 | 7846 | 64 | 7947 | 59 | 8208 | 73 | | |





Walter Binde Optik GmbH & Co. KG

Königstraße 134b | D-32427 Minden
Postfach 2160 | D-32378 Minden

Auftragsannahme: +49 (0)5 71 / 2 80 13
 +49 (0)5 71 / 2 80 14
Telefax: +49 (0)5 71 / 8 51 11
Nach Geschäftsschluss Anrufbeantworter

Bestellung: bestellung@binde-optik.de
Buchhaltung: fibu@binde-optik.de

www.binde-optik.de